



Product Description: Vela™PIR 30W Adjustable IP65 Driverless Floodlight

The driverless range of VelaPIR™ floodlights comes complete with an ultra slim profile and high performance. Delivering 100lm/W and with the product being salt spray tested, it offers a solution for coastal applications.

SKU Code	Wattage	Colour	Lumens	Lumens/Watt	Beam Angle	Finish Colour	SKU Type
EN-FLV30P/40	30	4000	3000	100	110	Black	Non Dimmable

Line Drawing

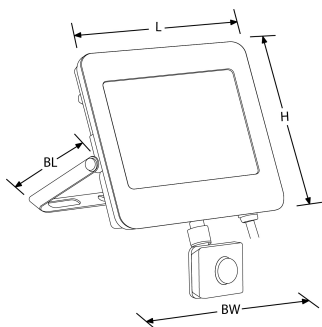

Polar Curve

Colour



Black

Product Features:

- Aluminium housing for excellent heat dissipation
- Floodlight IP65 rated (PIR sensor IP44 rated)
- Pre-wired with 800mm of cable
- 3 Year Warranty
- Tempered frosted glass
- IK06 rated

Product Specs:

Input Voltage	220~240V AC	Input Frequency	50/60HZ
Power Factor	0.9	IP Rating	IP65
Lifetime L70 (hrs)	30000	IK Rating	IK06
Width (mm)	160	Height (mm)	118
Product Type	Floodlights	Operating Temp. (Min) °C	-35°C
Operating Temp. (Max) °C	45°C		

Compliance & Approvals:

Warranty:

This product has a warranty period of 3 Years. Warranties may be available on certain products as indicated in the product description. Warranties are valid from the date of purchase. The warranty is invalid in the case of improper use, installation, tampering, removal of the Q.C. date label or installation in an improper working environment or installation. Should this product fail during the warranty period it will be replaced free of charge, subject to the correct installation of the original product and subsequent return of the faulty unit. Aurora does not accept responsibility for any installation costs associated with the replacement of this product and Aurora reserves the right to alter specifications without prior notice.