



70 RT HP is a new range of 16A to 160A switch disconnectors in isolating material and metal, supplied in a box. Available in control and emergency versions, the range is completed by board versions for front-panel or DIN rail assembly, in 16 to 63A options, all of which can be equipped with auxiliary contacts. These devices have been designed to deliver the ultimate in reliability, functionality and performance. They offer a technologically advanced solution that simplifies installation, reduces wiring times and ensures maximum safety and robustness, even in the most demanding conditions, thanks to the use of high-performance materials.

Version	Box	Material	Insulation
Type	For emergency	Rated current (A)	63
Circuit breaker	Rotary isolator	IP degree	IP66/IP67/IP69
Shock resistance		IK08	Ambient temperature
Lid screws (no. and type)	4 insul. a 1/4 turn	Holes entry	-25 +60 °C
Lockable	YES (max. 3 locks in OFF)	Complete with	2 x M25/32 + 2 x M25/32
Current in AC22 (415V)		63	Max. 2 auxiliary contacts
Cable section	Max 25 mm ²	Current in AC23 (415V)	63
Electrocod	1742	Outer dim. LxHxD (mm)	156x200x95

BEHAVIOUR WITH CHEMICAL AND ATMOSPHERIC AGENTS

Saline solution	Acids		Bases		Solvents				Mineral oil	UV rays
	Concentrated	Diluted	Concentrated	Diluted	Hexane	Benzol	Acetone	Ethyl alcohol		
Resistant	Limited resistance	Resistant	Not resistant	Limited resistance	Limited resistance	Not resistant	Not resistant	Limited resistance	Resistant	Resistant

DIMENSIONAL

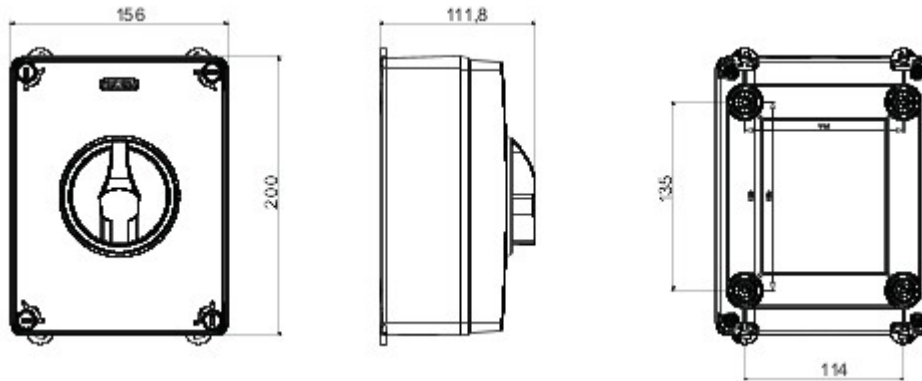

TECHNICAL SYMBOLOGY STANDARDS/APPROVALS

