

MB5 - MALLEABLE CONDUIT BOX

Description :

MB5G / B - 20mm Intersection Malleable Conduit Box

Finish :

Galvanised (G) or Black Enamel (B)

Material :

Malleable Iron

Packaging :

Packed in qty 10

Additional Notes :

Compliant to LU Standard 1-085
(For use on surface & sub-surface locations)

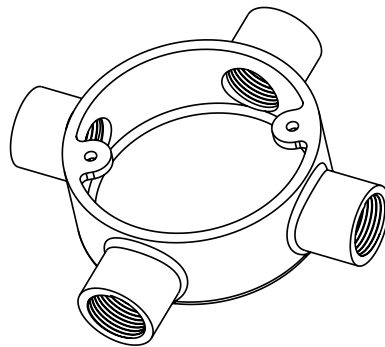
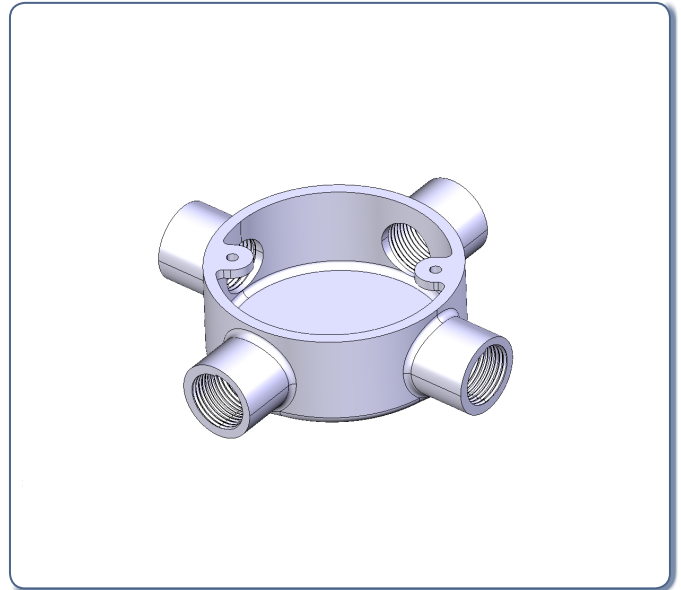

Isometric view

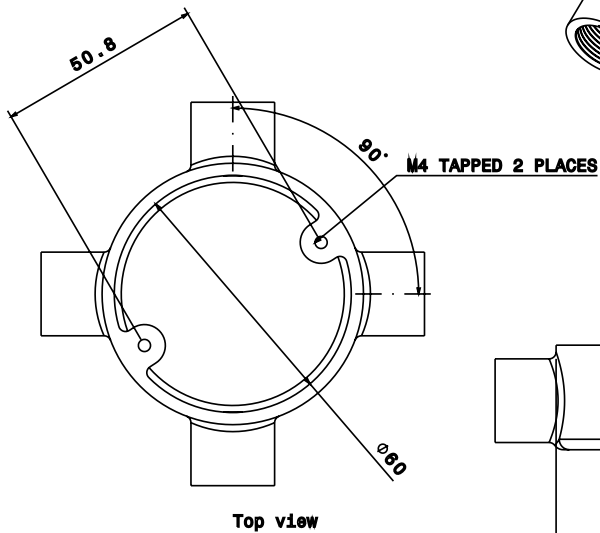

Top view

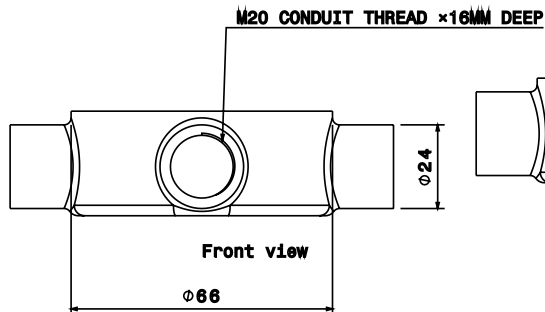

Front view

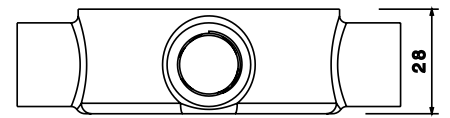

Side view

All Dimensions in mm (unless otherwise stated)

© Metpro Ltd 2015 - This Document is provided for Information Purposes Only and is Subject to Change Without Notice. Metpro Ltd makes No Warranty, express or implied, with this Document or the Information contained within.

Tel : 0121 552 2100 - Fax : 0121 552 3363 - Email : sales@metpro.co.uk