

WN6 - WEDGE NUT

Description :

WN6 - M6 Wedge Nut

Finish :

BZP

Material :

Steel

Packaging :

Packed in qty 100

Additional Notes :

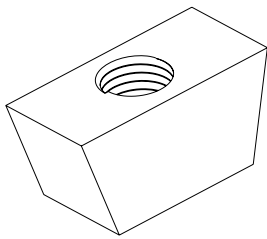
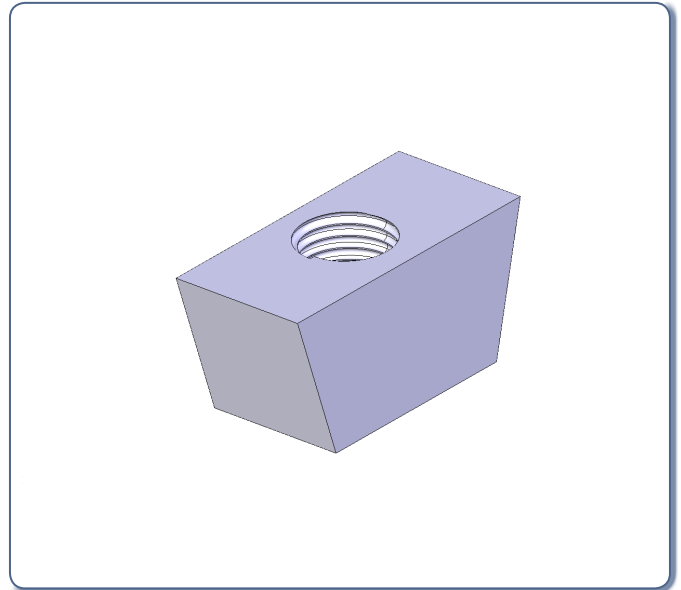

Isometric view

	A	B	C	D
WN6	M6	12	25	18
WN8	M8	12	25	18
WN10	M10	12	25	18
WN12	M12	15	30	21.7

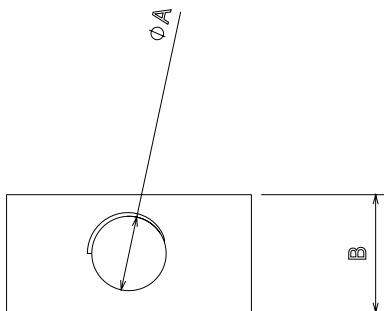

TOP VIEW

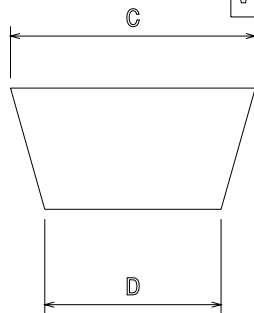

SIDE VIEW

All Dimensions in mm (unless otherwise stated)

© Metpro Ltd 2015 - This Document is provided for Information Purposes Only and is Subject to Change Without Notice. Metpro Ltd makes No Warranty, express or implied, with this Document or the Information contained within.

Tel : 0121 552 2100 - Fax : 0121 552 3363 - Email : sales@metpro.co.uk