

Pushbuttons B3



- IP65 protection
- Opaque or illuminated
- Metal or Black bezels
- Snap-on contact blocks
- Colour coded contacts
- Pushbutton stations
- International approvals including UL and CSA



Options and ordering codes

To order – select actuator + mounting collar + contacts

Actuator		BS	3	D	Green
Metal bezel	B				Colour Refer to colours available
Black bezel	BS				
Chrome bezel	BC				
Actuator 22.5mm			3		
				D	Flush
				DL	Flush illuminated
				P	Mushroom
				K	Rotary
				KR	Rotary lever
				A	Key operated
				R	Lens cap
				DLBR	Flush maintained
				DT	Twin head
				DR	Flush maintained
				DLR	Flush illuminated maintained

Mounting collar		B3	S
Series		B3	
			S
			M

Exploded view

- A** Actuator or lens cap.
- B** P642 insert for use with contact in centre position
- C** B4V extension bar
- D** Locking ring
- E** Mounting collar
- F** Contact blocks/lampholders
- G** Base/DIN rail mount

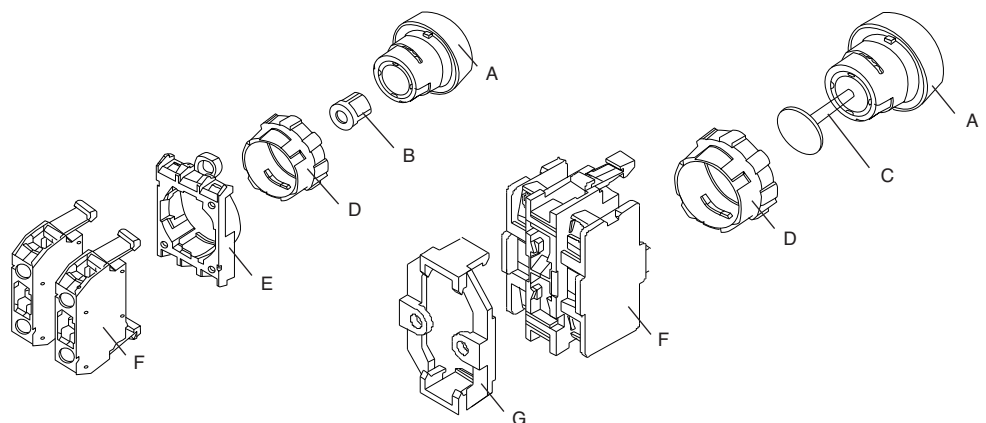

Selection and product ordering codes

○ Metal Bezel ● Black Bezel ● Chrome Bezel

Opaque

Momentary



Description		Product
Flush	○	B(S,C)3D
Green-Red-Black	●	
Yellow-Blue	●	
Mushroom 28mm	○	B(S,C)3P1
Red-Red 0-Yellow	●	
Black	●	
Mushroom 40mm	○	B(S,C)3P14
Red 0	●	

Maintained



Mushroom 28mm	○	B(S,C)3P3
Twist to Release	●	
Red-Red 0	●	
Mushroom 40mm	○	B(S,C)3P34
Twist to Release	●	
Red 0	●	
Mushroom 40mm	○	BS3P44S3
Key Release	●	
Red	●	
Mushroom 40mm	○	BS3P44
Pull to Release	●	BS3P45
Red	●	

Rotary knob



3 posn. spring	○	
Return to centre	●	B(S,C)3KN1
60°-0-60° Black	●	
2 posn. maintained	○	
0-60° Black	●	B(S,C)3KN2
3 posn. maintained	○	
60°-0-60° Black	●	B(S,C)3KN3
Lever 3 posn.	○	
Spring return	●	B(S,C)3KRN1
60°-0-60° Black	●	
Lever 3 posn.	○	
Maintained	●	B(S,C)3KRN3
60°-0-60° Black	●	
3 Posn. spring	○	
Return from right	●	B(S,C)3KN6
Maintained left	●	
3 Posn. spring	○	
Return from left	●	B(S,C)KN7
Maintained left	●	
2 Posn. maintained	○	
30°-30°	●	B(S,C)3KN8
2 Posn. spring	○	
Return from left	●	B(S,C)3KN9
2 Posn. toggle	○	
Switch without off	●	B(S,C)3KN10

Twin Head



Double head	○	
Momentary indicating	●	B(S,C)3DT
Red/Green - Black/White	●	

Key Operated Maintained



Description		Product
2 Posn.	○	
Key Remove-Off	●	B(S,C)3SAR1
2 Posn.	○	
Key Remove-On	●	B(S,C)3SAR1
2 Posn.	○	
Key Remove-All	●	B(S,C)3SAR01
3 Posn.	○	
Key Remove-Off	●	B(S,C)3SARRO
3 Posn.	○	
Key Remove-All	●	B(S,C)3SARR102
Spring return	●	
2 Posn.	○	
Key Remove-Off	●	B(S,C)3SAT0
3 Posn.	○	
Key Remove-Off	●	B(S,C)3SATTO

Illuminated

Momentary



Description		Product
Flush	○	
Green-Red-White-Blue	●	B(S,C)3DL
Yellow-Clear	●	

Maintained Illuminated/Non-Illuminated

Flush illuminated maintained	○	
Blue-Green	●	B(S,C)DR
Red-White-Yellow	●	
Flush maintained	○	
Blue-Green	●	B(S,C)3DLR
Red-White-Yellow	●	

Lens Cap



Low Profile	○	
Red-Yellow-Green	○	B3R
Clear-White-Blue	○	
Plastic	○	
Red-Yellow-Green	●	B3RF
White-Blue	●	

Rotary knob



3 posn. spring	○	
Return to centre	●	B(S,C)3KL1
60°-0-60° Clear	●	
2 posn. maintained	○	
0-90° Clear	●	B(S,C)3KL2
3 posn. maintained	○	
60°-0-60° Clear	●	B(S,C)3KL3
Lever 3 posn.	○	
Spring return	●	B(S,C)3KRL1
60°-0-60° Clear	●	
Lever 3 posn.	○	
Maintained	●	B(S,C)3KRL3
60°-0-60° Clear	●	

Options and ordering codes

	B4	TU	01	F
Series	B4 B3			
Contact block		T		
Contact block inverted terminals		TU		
1 break			01	
1 make			10	
Lamp holder				F
Lamp holder with series resistor				FW
Lamp holder with transformer				FST

Accessories

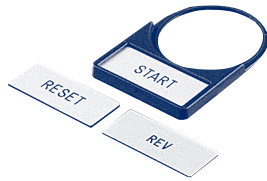

Description	Product
Lamps BA9S 6V 24V 42V 1.2W 130V 2.6W Neon 240V 110V	Lamp __ V Neon __ V
Legend plate with holder	
Holder	P751
Blank	BK4-9736
Legends–start–stop–reset– fwd–rev–hoa	BK4 __ LEG
Mounting Collars	B3S/B3M
Base or DIN mounting adaptor	B4U
Sealing shroud 0 to 50 °C	P279-1
Sealing shroud -40 to +60 °C	P279-2
Spare key	B4-R455
Adaptor ring for 30.5mm holes	B4-7282
Coupler for BKLG enclosures	B4-8852
Actuator – insert for centre position	P642
Push button wrench	J7049
Contacts for use with enclosures	
1 make	B4TU10
1 break	B4TU01
2 makes	B4TU20
2 breaks	B4TU02
1 make + 1 break	B4TU11
With lamp holder	
1 make	B4TU10F
1 break	B4TU01F
2 makes	B4TU20F
2 breaks	B4TU02F
1 make + 1 break	B4TU11F

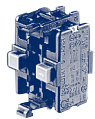

Contact assemblies

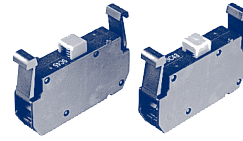

Description	Product
1 make	B3T10
1 break	B3T01

Lamp holder and contact assemblies

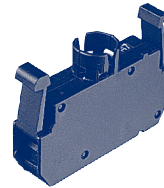

Description	Product
Lamp holder only (1.7W max)	B3F
Lamp holder with dropper resistor 110 or 230V AC – down to 42V	B3FW
Lamp holder with series resistor 230 down to 130V 2.6W	B3FR
Lamp holder and transformer 230 or 415V AC – down to 6V	B4FST
Transformer only 230 or 415V AC – down to 6V	B4ST

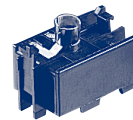

Description	Product
Contacts for use with enclosures	
With series resistor 110 or 240V AC to 42V lamp 1 make	B4TU10FW
1 break	B4TU01FW
Lamp base only for BA9S	B4FU
Lamp base and resistor 110 or 240V AC to 42V lamp	B4FWU
Transformer and lamp base 240 or 415V to 6V lamp	B4FSTU



Enclosures	
Single	BG1
Single with yellow lid	BG1YEL
Double	BG2
Triple	BG3



Assembled units	
Emergency stop 40mm maintained turn to release yellow lid with 2 N/C contacts	BG10P34
Emergency stop 40mm maintained key release yellow lid with 2 N/C contacts	BG10P44S3
Start-stop flush green and red pushbuttons 2 way with 1 N/O and 1 N/C contact	BG20
Mushroom pushbutton red Ø70mm yellow lid with 2 N/C contacts	BG10P34P
Foot and Palm switch mushroom pushbutton Ø70mm grey with 1 N/O and 1 N/C contacts	BG10P14PGR



Technical data

Terminal markings for control units according to DIN EN 50013

Distinc. number	Contacts elements	Distinc. number	Contacts elements	Distinc. number	Contacts elements	Distinc. number	Contacts elements	Distinc. number	Contacts elements	Distinc. number	Contacts elements
10										01	
20		11								02	
30		21		12						03	
40		31		22		13				04	

Colour Codes

The actuators of the contact blocks are colour coded, green for NO, red for NC. The colour code permits to know the function of contacts at first sight and gives additional safety against wrong wiring.

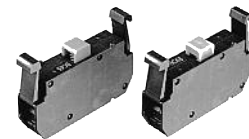

Exploded view enclosure assembly

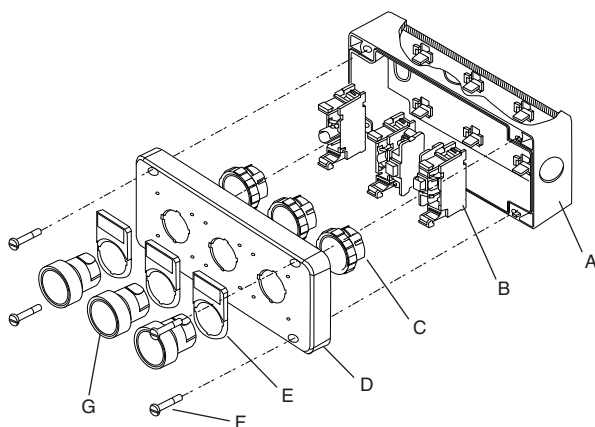

- A** Enclosure base with built in contact block clips
- B** Contact blocks/lamp holders
- C** Locking ring
- D** Enclosure lid
- E** Legend plates
- F** Captive screws (after screw in) loose in enclosure on delivery
- G** Actuators and lens caps

Specification

Data according to IEC947-5-1, VDE0660, EN60947-5-1

Rated insulation voltage		V AC	500
AC12 – resistive loads	220-240V	A	10
	380-415V	A	10
AC15 – Electromagnetic loads	220-240V	A	6
	380-415V	A	5
DC12 – resistive L/R = 1mS	24V	A	10
	60V	A	6
	110V	A	2.5
	220V	A	0.8
DC14 – Electromagnetic L/R = 15mS	24V	A	8
	60V	A	1
DC14 – With economy resistors	110V	A	2
	220V	A	0.5
	220V	A	0.2
DC13 – Electromagnets L/R = 300mS	24V	A	2
	60V	A	5
	110V	A	0.5
	220V	A	0.2
Mechanical life	Millions of operations		10
Contact life (AC15)	100VA	Millions of operations	10
	300VA		3
	800VA		1
	1200VA		0.5
Maximum frequency of operations	Ops per hour		600
Short circuit protection	slow gL	A	10
Ambient temperature		°C	-20 to +50
Cable cross-section	Solid	mm ²	0.5 – 2.5
	Flexible	mm ²	0.5 – 2.5
	Cables per clamp		2
Mounting hole		Ømm	22.5
Mounting position			Optional
Terminal screws			Pozidrive No 2 screws 3.5

Dimensions (mm)

Panel mounting

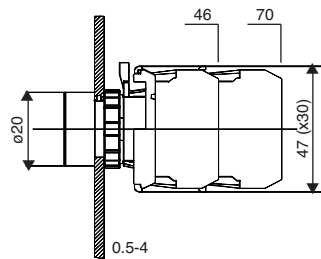

Base mounting

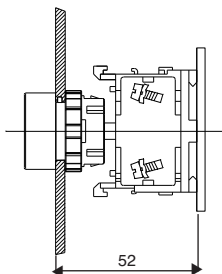

DIN-rail mounting

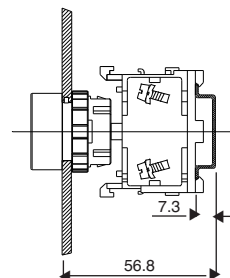

Mounting holes

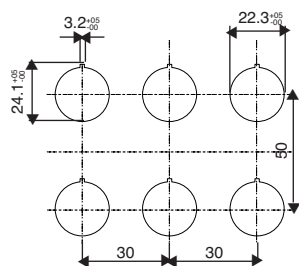

Dimensions of minimum space requirements (according to EN 50007 and IEC337-2C). Take into consideration the field of traverse of swing knobs (27mm) and the diameter of mushroom heads.

Contact blocks Lamp holders B4 . . .

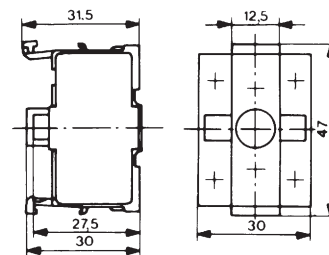

Base B4U

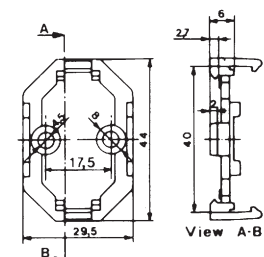

Enclosures for Custom Built Stations

Three conduit entries (knockouts), each on top, left and right side, suitable for Pg 13.5. Version "CSA" with three knockouts \varnothing 22.2mm.

