

Unity CV3

Low Energy Continuous Extract Fan



A FAN DESIGNED TO DELIVER **GUARANTEED INSTALLED PERFORMANCE**





#PerformanceIsEverything

Adequate ventilation is critical for our health and wellbeing as well as for keeping our homes free from mould and condensation. However intrusive noise, concerns about running costs or under performing installed products can mean that ventilation rates are not achieved.

Unity CV3 is the next generation of extractor fan, and has been designed to take on board the continued importance of reducing energy usage, easy compliance as well as contribution to well-being by eliminating nuisance noise.

#IndoorAirQuality

#HealthyHomes

#GuaranteedInstalledPerformance

#LessThan&1aYeartoRun

#DoNotDisturb

DID YOU KNOW?

GREENWOOD INVENTED dMEV FANS

2007



Unity CV100

2011



Unity CV2GIP

2017



Unity CV3

Unity CV3 the next generation of dMEV

Low energy continuous ventilation suitable for new and existing homes.



Greenwood SMART Technology



A Greenwood GIP Product
designed to ensure that installed performance can be achieved easily.

Installed performance

For confidence of performance and easy compliance, Unity CV3 has integrated airflow sensing that ensures performance from the point of installation and throughout its life.

Less nuisance noise

Nuisance noise is eliminated with running levels as low as 14.5dB (min) and SMART sensors that ensure the fan only boosts when required. It really is as quiet as a whisper!

Also now including **Do Not Disturb** feature.

Less energy

Unity CV3 costs less than £1 to run for the entire year – up to 50%* less than other comparable products in the market. It also offers an outstanding SFP Performance and reward in SAP.

Set and forget

A range of tamper-proof settings can ensure that the fan can perform as expected, minimising user interference and ensuring effective ventilation.

Contactless

Set-up, control and customise Unity CV3 during and post installation with a simple tap of your smartphone.

INDOOR AIR QUALITY AND VENTILATION GO HAND IN HAND

DID YOU KNOW?

Continuous ventilation provides **5 times more ventilation** than intermittent - and even with low running costs.

With increasing focus on indoor air quality and improving insulation in homes, continuous ventilation offers the best option for healthy homes and elimination of mould and condensation.

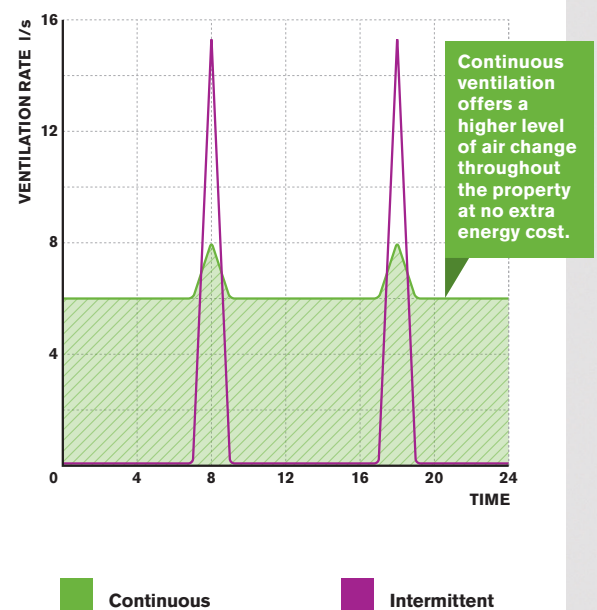

* based on comparisons of current products available on the market

For an air of confidence.



Air sensing technology automatically senses, reacts and extracts to achieve the correct installed airflow in each installation.

Guaranteed Installed Performance.



Once installed, CV3 uses air sensing technology to measure and self-regulate the airflow to achieve the correct extraction rate for the room.

This contributes to delivering good indoor air quality and helps eliminate issues such as mould and condensation because the fan is doing what it is designed to do.

#GuaranteedInstalled Performance

Reduced time, more savings, total confidence.

With Greenwood CommissionSMART™ technology, commissioning and installed performance is achieved quickly and efficiently without the need for the installer to undertake additional testing on-site with an airflow meter.



AIR SENSING TECHNOLOGY USED IN CV3 IS TESTED AT THE POINT OF MANUFACTURE USING UKAS ACCREDITED TESTING EQUIPMENT.

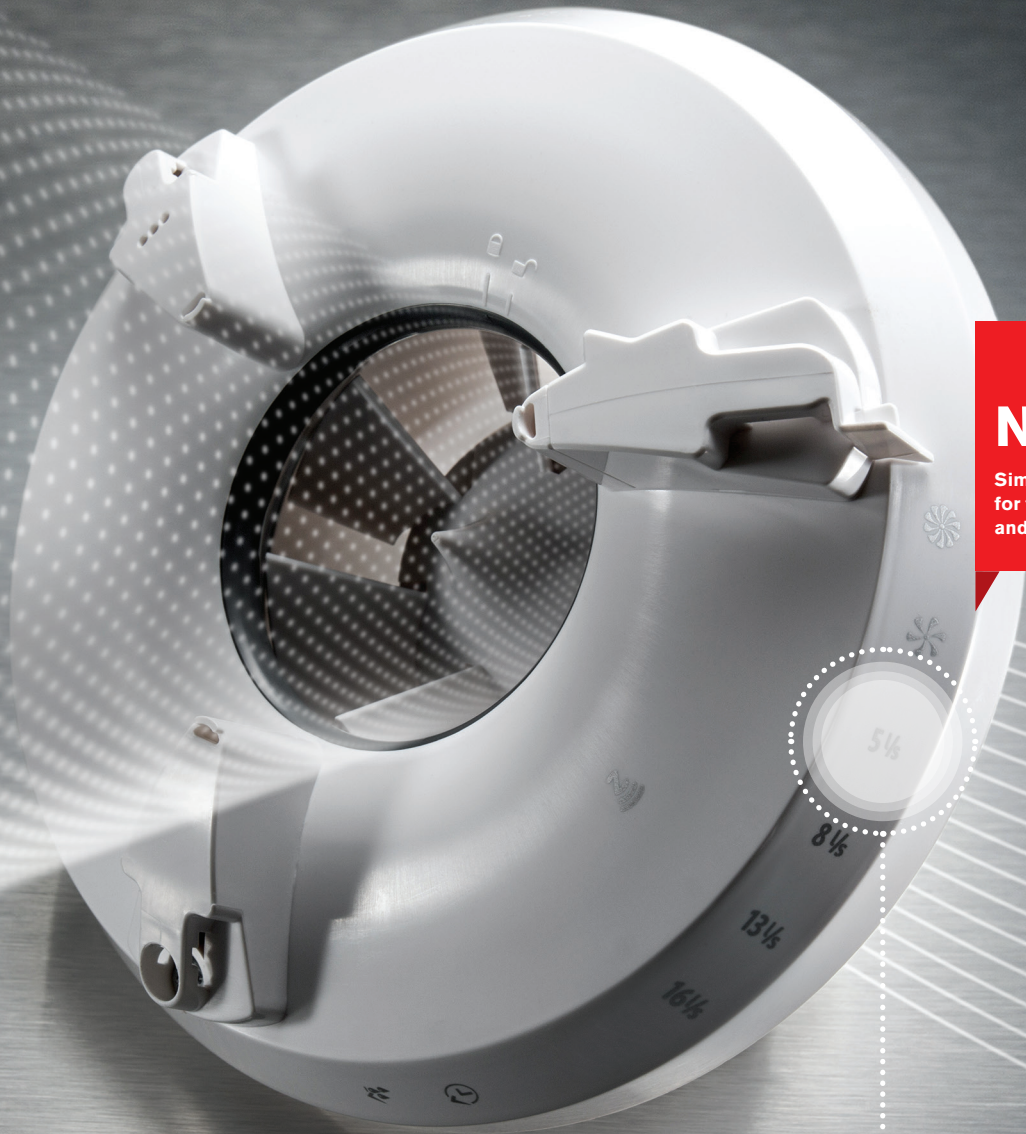

New
Simple touch buttons
for the easiest set-up
and no mistakes.

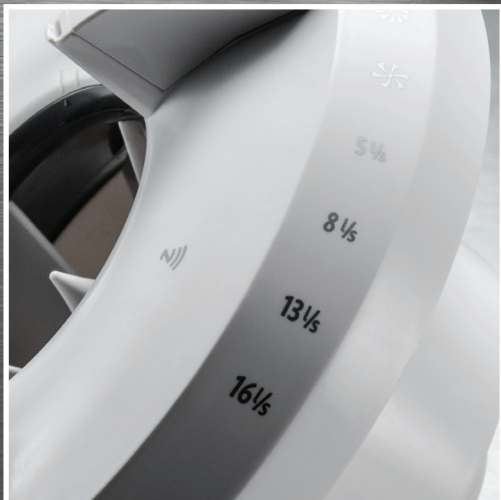

TOUCH TO SET

Unity CV3 uses capacitive touch technology for quick and easy set-up on-site – simply touch to set the speed required.

Four airflow performance points are available to meet regulation room rates requirements easily for trickle and boost speeds.

5 1/2

8 1/2

13 1/2

16 1/2

Never 'bean' cheaper

CV3 is an ultra low energy ventilation solution designed to do the job it is supposed to do without costing the earth.

This is especially important for tenants and homeowners as well as having positive impact in SAP for new building dwellings.



97p for the entire year

Unity CV3 has one of the lowest running costs for continuous ventilation – less than the cost of two cans of branded baked beans for the entire year!

Specific Fan Power Performance – PCDB

Rigid Ducting

Configuration	Location	SFP (w/l/s)
In-room	Kitchen	0.16
	Bathroom	0.12
Through-wall	Kitchen	0.13
	Bathroom	0.11

Flexible Ducting

Configuration	Location	SFP (w/l/s)
In-room	Kitchen	0.16
	Bathroom	0.12
Through-wall	Kitchen	0.13
	Bathroom	0.11

Pre-set Speeds

Airflow	Power (W)
5 l/s	0.72
8 l/s	0.9
13 l/s	1.5
16 l/s	2.1

Low Watt – so what?

We can demonstrate low running costs for CV3, but how does this translate?

How does CV3 compare to everyday items in the home?

Cost to run per year

Equivalent to running:

1 1Kw microwave



£12.73*
based on 15 minutes usage per day.

=

13
CV3
fans per annum

1 Leading games console



£38.75*
based on 2 hours usage per day.

=

39
CV3
fans per annum

1 9Kw electric shower



£80.73*
based on 10 minutes usage per day.

=

83
CV3
fans per annum

* based on 12p/Kwh

Do.Not.Disturb.

One of the main reasons that a fan in the bathroom or kitchen is turned off is because it's causing a nuisance to occupants – mainly because of noise.

Switching off fans has consequences on both the building and the health and well-being of occupants. The need for quiet and effective continuous ventilation is fundamental to eliminating issues with mould and condensation and associated indoor air quality issues.

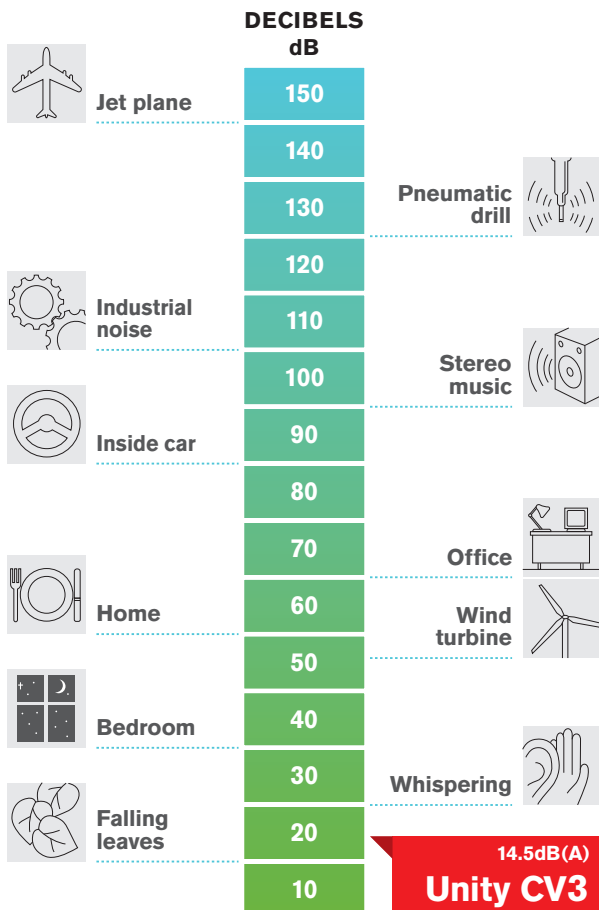

14.5_{dB(A)*}

That's how quiet Unity CV3 is.

That's 10% quieter than one of the best performing fans on the market.

The quiet running speed has been achieved through a combination of innovative motor, electronics and aerodynamic impellor design.

It's all about the pitch

With continuously running fans, the pitch or frequency of the noise is often the root of nuisance noise. CV3 has been designed to overcome these issues.



* noise at pre-set speed 5l/s

PLEASE
DO NOT
DISTURB



ELIMINATING NUISANCE NOISE WITH SMART TECHNOLOGY



Greenwood TimerSMART™

Smart Timing is unlike other fans that have a pre-set timer that activates even if you take a quick trip to the bathroom. Instead it looks at duration of time e.g. in for 10 minutes, overrun for 10 minutes... (and no overrun if you are less than 5 minutes).



Greenwood HumidiSMART™

Smart Humidity Sensing is unlike other fans that use a pre-set point to activate boost. Instead it is looking for man-made spikes in humidity – like taking a shower – to activate boost.

Eliminate unnecessary running (when it's a hot humid day) and energy wastage.

NEW

'Do Not Disturb' feature to tackle nuisance running at night. You can simply set a time frame e.g. 10pm-6am to turn off the boost function, so if you get up in the night the fan won't boost.

Landlords, how much is mould and condensation costing you?



Fans being turned off or not working correctly (poor airflow performance) play a huge part in the issue of mould and condensation in homes. These issues are costly to manage and rectify in terms of building fabric and tenant health.

Unity CV3 has been designed to give you the information you need to make decisions – keeping you informed about property/room conditions and how ventilation is **(or isn't)** performing.



Simply choose **Product Info** on the CV3 App to transfer data

Tap in to

REAL TIME INFORMATION

With contactless technology, for the first time ever – you can simply transfer data (more than just time logs) from the installed fan to the phone easily.

Just tap.
It's as simple as that.

The advantages of **customisation**

Customising ventilation settings can help overcome issues and problems in homes that have costly consequences;

- ▶ **Increase boost rates in problem properties where mould and condensation is constant.**
- ▶ **Activate Do Not Disturb where nuisance noise complaints are prevalent.**

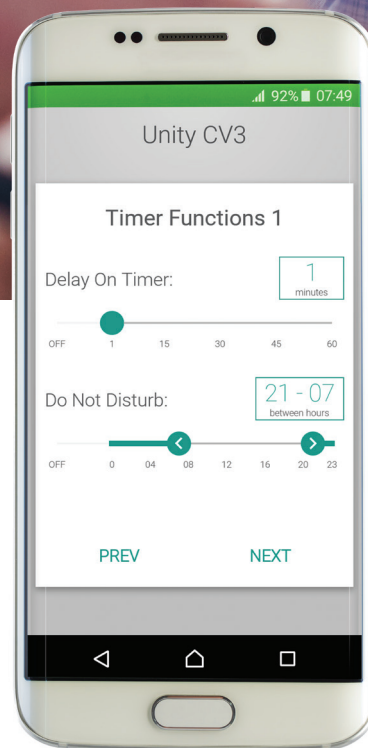

Tap to

CUSTOMISE

Enjoy more features to eliminate nuisance running and ensure good levels of indoor air quality throughout the day – once complete simply tap to the fan to transfer the information.

Tailored settings ensure specific problems can be resolved quickly and with no fuss.

Brand new 'Do Not Disturb' feature to tackle nuisance running at night. You can simply set a time frame e.g. 10pm-6am to turn off the boost function.



Watch more about the CV3 Data Transfer at greenwood.co.uk



Download the **CV3 App**
Also on greenwood.co.uk

Technical specifications

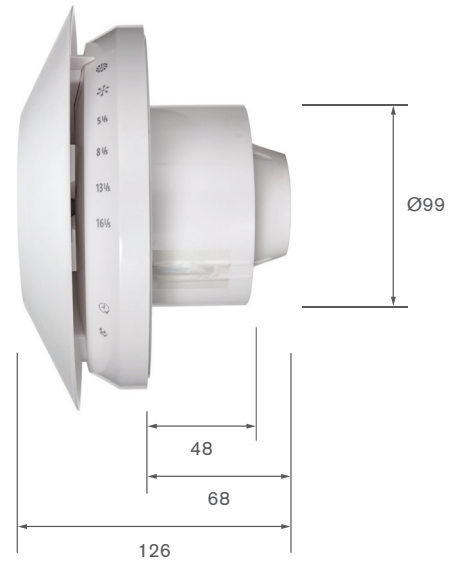

Physical specification

Weight: 0.53kg
Materials: White satin / gloss finish ABS / PCABS / PC plastic

Models and control options

Model	Control operation	IP	Voltage
CV3	Ultra Low Energy dMEV/Continuously running fan with Greenwood CommissionSMART™ technology and optional SMART Humidity and Timer options set-up at installation	IPX4 Ceiling IPX5 Wall	220–240
CV3SV	Low Voltage Ultra Low Energy dMEV/Continuously running fan with Greenwood CommissionSMART™ technology and optional SMART Humidity and Timer options set-up at installation	IPX4 Ceiling IPX5 Wall	24DC

Installation

Wiring: Must comply with IEE Regulations
Cable: Ø 2 core 1mm² max
 Ø 3 core 1.5mm² max
Fuse: 3 amp normally required (when fan is supplied from a 6A lighting circuit no local fuse is required)

Electrical specification: 220–240V~50Hz Class II SELV Class III
Consumption: Min 0.72W Max 2.1W (Pre-set speeds) Up to 6.4W (max variable airflow performance)

PRE-SET SPEEDS

Airflow (l/s) Energy consumption* (W)

5l/s **0.72**

8l/s **0.9**

13l/s **1.5**

16l/s **2.1**

Specific Fan Power Performance – PCDB

SAP Performance **

Rigid Ducting

Configuration	Location	SFP (w/l/s)
In-room	Kitchen	0.16
	Bathroom	0.12
Through-wall	Kitchen	0.13
	Bathroom	0.11

Flexible Ducting

Configuration	Location	SFP (w/l/s)
In-room	Kitchen	0.16
	Bathroom	0.12
Through-wall	Kitchen	0.13
	Bathroom	0.11

Please Note: Flexible ducting is not recommended. If used, it must be pulled to min 90% of its entire length. Flexible ducting can also be more difficult to support and retain internal shape/size which can impact performance.

Performance – Free Air

Speed setting	Airflow performance (l/s)		Energy consumption (W)		Sound pressure level @ 3m dB(A)
	Bathroom (Pre-set speeds)	Kitchen (Pre-set speeds)	Minimum	Maximum	
Trickle speed	5	8			
Boost speed	8	13	0.72	2.1	As low as 14.5dB (A)
Maximum speed	16	16			

Full third party accredited data is available on request

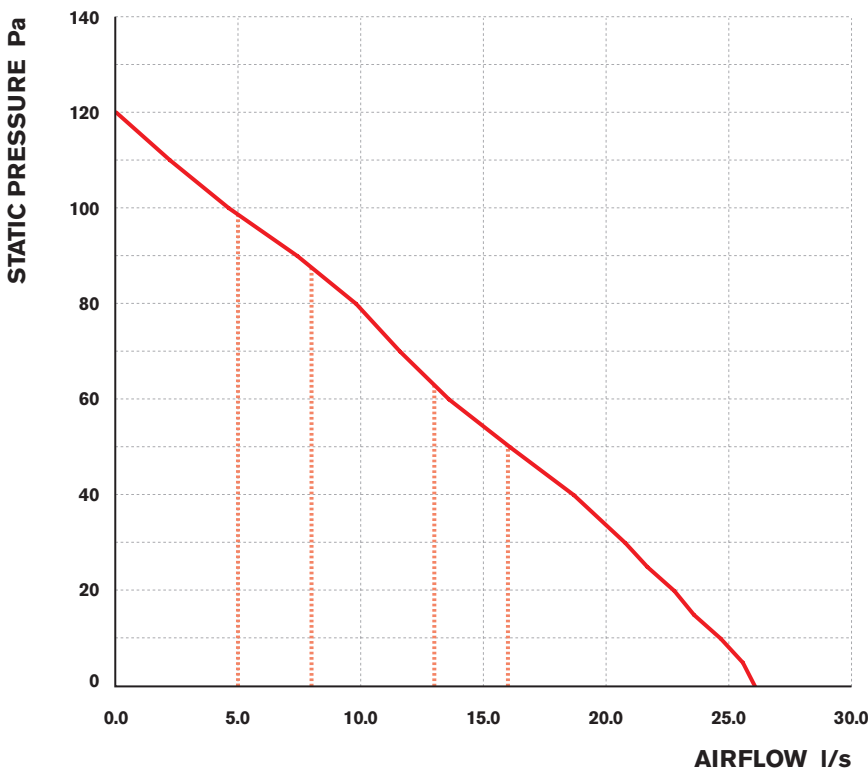

Key
——— Unity CV3/CV3SV 100% variable setting (via APP 5-20l/s)
..... Pre-set Speeds (via Fan)

* Measured in free air

** Information extracted from the full PCDB report (previously known as SAP Appendix Q) on www.ncm-pcdb.org.uk

Ancillaries

-  **SP13** PVC round pipe 100mm Ø x 350mm
-  **EG1** Complementary fixed blade louvred grille in brown or white
-  **GD4 / GD8** Modular lightweight PVC ducting system
-  **PFACV2** Picture frame adaptor / decorative cover for Unity
-  **GG42** External louvred wall vent available in white or brown
-  **Flexiduct** Flexible 100mm aluminium ducting
-  **FF100** Fast fix wall duct system. Comprises 100mm PVC duct, external wall duct seal and external grille, choice of white or brown grille

COMFOTUBE 110mm DUCTING

Easy to install, high performance, durable semi-rigid ductwork that provides improved efficiencies whilst supporting maintenance programmes as the patented 'Clinside' smooth interior, inhibits growth of mould and bacteria.



COMFOTUBE ADAPTER (CTA)

NEW

The CTA110 adapter provides efficient, quiet performance through effective inter-connection between the Unity CV3 fan and Zehnder ComfoTube 110mm ducting.

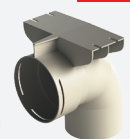

QUICK RELEASE ADAPTOR (QRA)

NEW

Easy access for maintenance and cleaning

When installed with the specially designed Quick Release Adaptor, the Unity CV3 is easily removed from its fittings, providing you with quick and efficient access to the fan for maintenance and cleaning... without the electrical wiring concerns.





UNITY CV3
THE NEXT GENERATION OF DMEV

Greenwood Airvac is a brand of Zehnder Group UK · Zehnder Group UK Ltd · Watchmoor Point · Camberley · Surrey · GU15 3AD
Registered in England: 2296696 · T: +44 (0) 1276 605800 · F: +44 (0) 1276 24058

For placing an order: orders@zehnder.co.uk · For general enquiries: retailsales@zehnder.co.uk aftersales@zehnder.co.uk

www.zehnder.co.uk · www.greenwood.co.uk