

# Product datasheet

Specifications



## limit switch XCMD - steel roller plunger - 1NC+1NO - snap - M12

Local distributor code: 398268444 XCMD2102C12

EAN Code : 3389110221312

### Main

Range of product	Telemecanique Limit switches XC Standard
Series name	Standard format
Product or component type	Limit switch
Device short name	XCMD
Sensor design	Miniature
Body type	Plug-in body
Head type	Plunger head
Material	Metal
Body material	Zamak
Head material	Zamak
Fixing mode	By the body
Movement of operating head	Linear
Type of operator	Spring return roller plunger metal
Type of approach	Lateral approach, 2 directions
Number of poles	2
Contacts type and composition	1 NC + 1 NO
Contact operation	Snap action

### Complementary

Switch actuation	By 30° cam
Electrical connection	Male connector M12, 5 pins
Contacts insulation form	Zb
Positive opening	With
Positive opening minimum force	35 N
Minimum force for tripping	7 N
Maximum actuation speed	0.5 m/s
[Ie] rated operational current	0.22 A at 50 V, DC-13 conforming to EN/IEC 60947-5-1 appendix A 3 A at 50 V, AC-15 conforming to EN/IEC 60947-5-1 appendix A
[Ithe] conventional enclosed thermal current	4 A

<b>[Ui] rated insulation voltage</b>	60 V (pollution degree 3) conforming to IEC 60947-5-1
<b>Maximum resistance across terminals</b>	25 mOhm conforming to IEC 60255-7 category 3
<b>[Uimp] rated impulse withstand voltage</b>	0.8 kV conforming to IEC 60664 0.8 kV conforming to IEC 60947-1
<b>Short-circuit protection</b>	4 A cartridge fuse, type gG
<b>Electrical durability</b>	5000000 cycles, DC-13, 24 V, 3 W, operating rate <60 cyc/mn, load factor: 0.5 conforming to IEC 60947-5-1 appendix C 5000000 cycles, DC-13, 48 V, 2 W, operating rate <60 cyc/mn, load factor: 0.5 conforming to IEC 60947-5-1 appendix C
<b>Mechanical durability</b>	10000000 cycles
<b>Width</b>	30 mm
<b>Height</b>	50 mm
<b>Depth</b>	16 mm
<b>Net weight</b>	0.09 kg

## Environment

<b>Shock resistance</b>	25 gn for 18 ms conforming to IEC 60068-2-27
<b>Vibration resistance</b>	5 gn (f= 10...500 Hz) conforming to IEC 60068-2-6
<b>IP degree of protection</b>	IP66 conforming to IEC 60529 IP67 conforming to IEC 60529 IP68 conforming to IEC 60529
<b>IK degree of protection</b>	IK06 conforming to EN 62262
<b>Electrical shock protection class</b>	Class I conforming to IEC 61140 Class I conforming to NF C 20-030
<b>Ambient air temperature for operation</b>	-25...70 °C
<b>Ambient air temperature for storage</b>	-40...70 °C
<b>Protective treatment</b>	TC
<b>Product certifications</b>	CSA UL CCC
<b>Standards</b>	CSA C22.2 No 14 EN/IEC 60947-5-1 EN/IEC 60204-1 UL 508

## Packing Units

<b>Unit Type of Package 1</b>	PCE
<b>Number of Units in Package 1</b>	1
<b>Package 1 Height</b>	1.7 cm
<b>Package 1 Width</b>	7.1 cm
<b>Package 1 Length</b>	5.2 cm
<b>Package 1 Weight</b>	92.0 g
<b>Unit Type of Package 2</b>	S02
<b>Number of Units in Package 2</b>	50
<b>Package 2 Height</b>	15.0 cm
<b>Package 2 Width</b>	30.0 cm
<b>Package 2 Length</b>	40.0 cm
<b>Package 2 Weight</b>	5.105 kg

<b>Unit Type of Package 3</b>	PAL
<b>Number of Units in Package 3</b>	800
<b>Package 3 Height</b>	60.0 cm
<b>Package 3 Width</b>	80.0 cm
<b>Package 3 Length</b>	800.0 cm
<b>Package 3 Weight</b>	1017.6 kg

## Offer Sustainability

<b>Sustainable offer status</b>	Green Premium product
<b>REACH Regulation</b>	<a href="#">REACH Declaration</a>
<b>EU RoHS Directive</b>	Pro-active compliance (Product out of EU RoHS legal scope) <a href="#">EU RoHS Declaration</a>
<b>Mercury free</b>	Yes
<b>RoHS exemption information</b>	<a href="#">Yes</a>
<b>Environmental Disclosure</b>	<a href="#">Product Environmental Profile</a>
<b>Circularity Profile</b>	<a href="#">End of Life Information</a>

## Contractual warranty

<b>Warranty</b>	18 months
-----------------	-----------

Dimensions

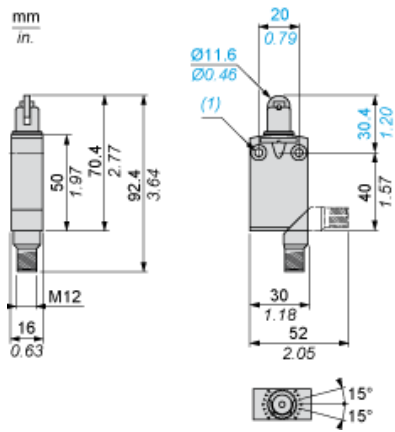

(1) 2 fixing holes  $\varnothing$  4.2 mm, counterbored  $\varnothing$  8 mm by 4 mm deep.

**Setting-up**

---

**Plunger or Multi-directional Heads**

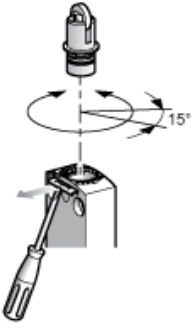

**Wiring Diagram**

---

**2-pole NC + NO Snap Action + Integral M12 5-pin Connector**

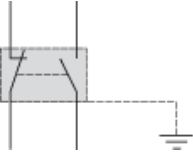

**Wiring Diagram**

---

5-pin, M12, 4A-60V

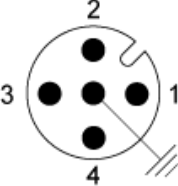

- 1 - 2 : NC
- 3 - 4 : NO
- 5 : Grounding

**Characteristics of Actuation**

---

**Switch Actuation by 30° Cam**

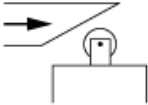



**Functional Diagram**

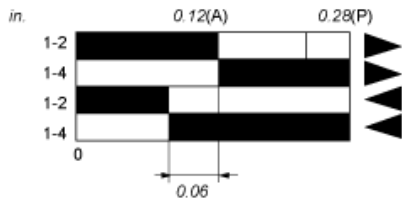
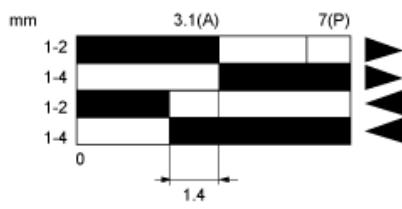

- (1)
- (2)
- ▶ (3)
- ◀ (4)

- (P) Positive opening point
- (A) Cam displacement
- (1) Closed
- (2) Open
- (3) Tripping
- (4) Resetting

**Recommended replacement(s)**