

**Standard Dimensions:**

The following are standard dimensions unless otherwise stated.

All dimensions subject to commercial tolerance.

- Hole Size: 14mm diameter
- Hole Spacing (From End): 20mm from end of fitting
- Hole spacing (On Center): 48mm center to center
- Fitting Width: 40mm

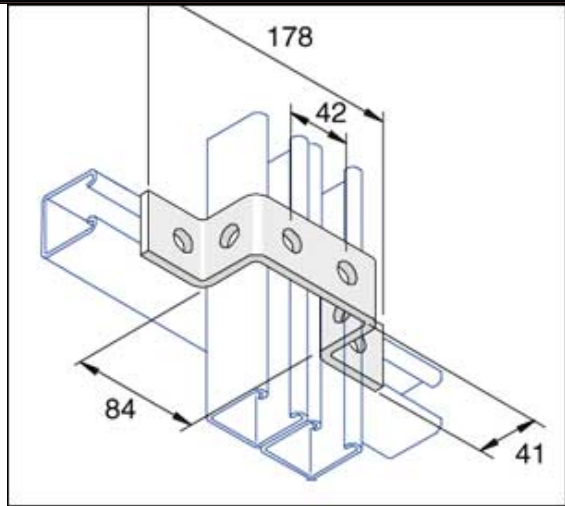

Part No.	Finish	Weight	Box Qty
P1043	HG	0.43	20
P1043	SS	0.44	20

Project: \_\_\_\_\_

Architect / Engineer: \_\_\_\_\_

Date: \_\_\_\_\_ Phone: \_\_\_\_\_

Contractor: \_\_\_\_\_

Address: \_\_\_\_\_

Notes 1: \_\_\_\_\_

**Approval Stamp:**