

CONNECT

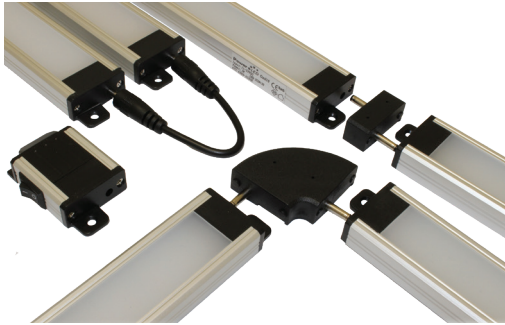

LED Light Bar



Key Features:

- Slimline bar suitable for cabinet lighting, display and accent lighting etc.
- Easy installation, multiple configurations
- Simple and safe low voltage on/off control
- Reverse polarity protected
- Simple link up capability, allowing up to 4 metres of lighting from 1 driver
- Rugged aluminium extrusion with easy fit mounting points
- Suitable for 24VDC vehicle applications
- Constant power technology, ensures balanced light output across each fitting

CONNECT SPECIFICATION

Part Code	CON210	CON210W	CON310	CON310W	CON510	CON510W
Lumen Output	280lm	225lm	420lm	350lm	620lm	520lm
Input Voltage	24VDC	24VDC	24VDC	24VDC	24VDC	24VDC
Current	125mA	125mA	200mA	200mA	350mA	350mA
Power	3W	3W	4.8W	4.8W	8.4W	8.4W
Power Consumption	3.2W	3.2W	5W	5W	9W	9W
LED Type	3528	3528	3528	3528	3528	3528
LED Qty	30	30	48	48	84	84
Light Length	200mm	200mm	300mm	300mm	500mm	500mm
Weight	62g	62g	94g	94g	155g	155g
Beam Angle	120°	120°	120°	120°	120°	120°
IP	IP44	IP44	IP44	IP44	IP44	IP44
CCT	5600 ~ 7000K	2800 ~ 3200K	5600 ~ 7000K	2800 ~ 3200K	5600 ~ 7000K	2800 ~ 3200K
Dimensions	223.6 x 30 x 12.3mm		323.6 x 30 x 12.3mm		523.6 x 30 x 12.3mm	

Mechanical Specification

CON210

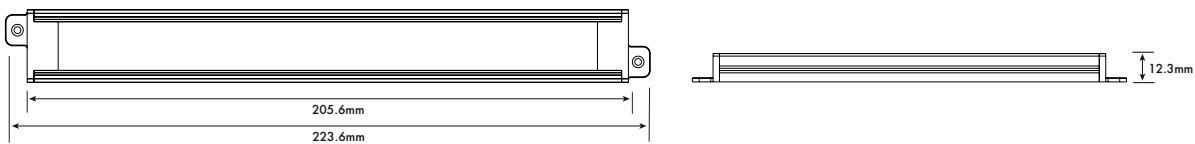

CON310

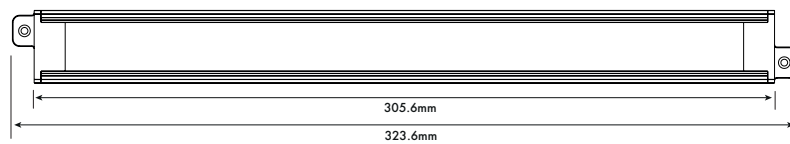

CON510

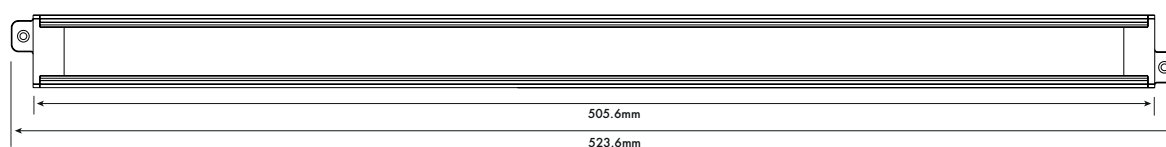

PowerLed
Orion House
Calleva Park
Aldermaston
Berkshire
RG7 8SN

Contact:
Tel: 0118 9703856
enquiries@powerled.uk.com
www.powerled.uk.com



CONNECT Series

LED Light Bar

CONNECT SPECIFICATION

Part Code	F90	F180	S180	PS1	SW1	CLC-1	CON-PIR
Style	Corner	Straight	Cable	Cable	Switch	Connector Cable	PIR Sensor
Max Current	3A	3A	3A	3A	3A	3A	2A
Angle	90°	-	Flexible	Flexible	-	Flexible	-
Weight	17g	6g	7g	-	-	-	-
Dimensions	-	-	150mm	500mm	-	1500mm	-

Connectors

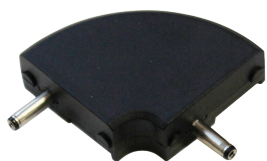

F90

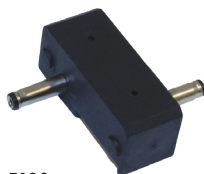
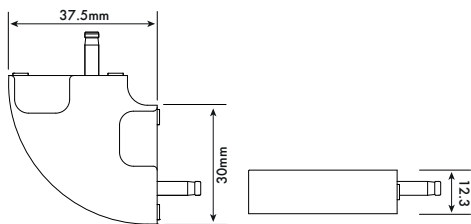

F180

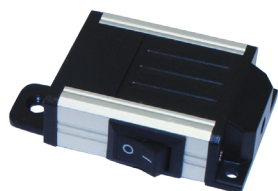
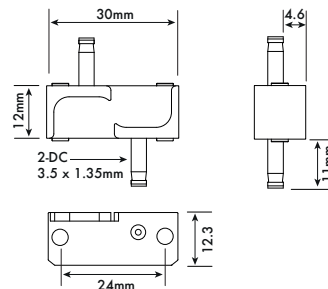

SW1

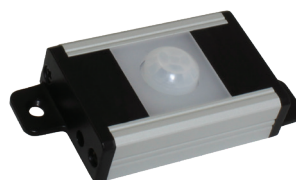
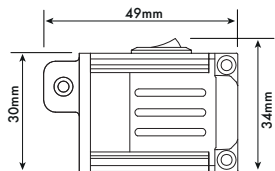

CON-PIR

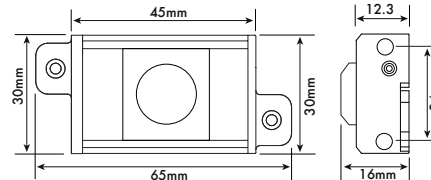

All connector dimensions are 3.5 Ø mm Ø/D x 1.35 Ø mm l/D x 11mm long

Maximum 2.5m length of connect bars.

CONNECT Series

LED Light Bar

Connect Connections

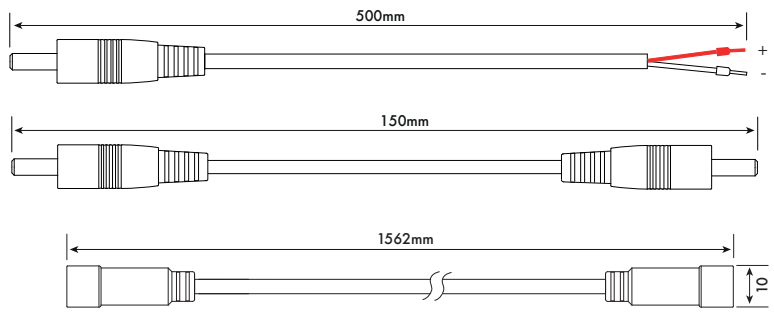

CLC-1 Extender cable Connector

This new extender cable can be easily connected between led light bars to extend the overall desired length. Use between two S180 cables or a combination of a S180 cable and a PS1 cable.

SUGGESTED LED DRIVERS

Part Code	PSU001	PSU002	PSU003	PSU004
Metres Powered	1.2mtr	2.1mtr	3mtr	4mtr

Maximum single run 4 metres when using standard PS1 input cable and F180 connections.

Connect Photometric

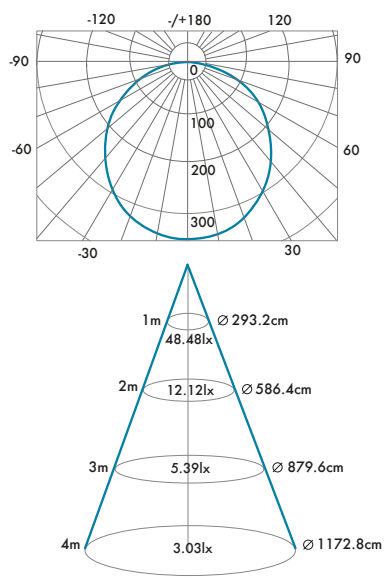

PowerLed Drivers and Connect connections must be used to provide power for the Connect series of LED Light Bars. Warranty will be void if alternative drivers or connections are used.