

niGLON

Wiring Accessories

MEDIAN

NSPB251 Mounting Pattrress



**20
YEAR
GUARANTEE**

A new take on traditional moulded wiring accessories manufactured in bright white Urea.

Technical Drawing

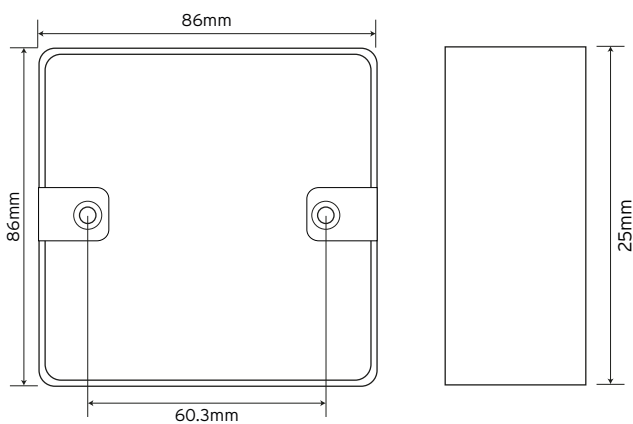

Technical Specifications

No Gangs	1
Material Composition	Front Plate - Urea
Anti Microbial Certified	Yes
IP Rating	IP20
Operational Temperature	-5° to +40°C
Standards	BS 5733 : 2010 + A1 : 2014, Modified ISO 22196
Dimensions	86x86x25mm (HxWxD)
Warranty	20 Years