











# Cable management product selector

## uPVC perimeter trunking

| Range                             | Ultimate 60   | Ultimate 62   | Cableline 50   |   |   |
|-----------------------------------|---|---|--|---|---|
|                                   |  |  |  |  |  |
| Compartments                      | 3   | 2   | 3  | 3   | 3   |
| Size                              | 150 x 60mm  | 190 x 62mm  | 180 x 52mm   | 180 X 52mm  | 180 X 52mm  |
| Length                            | 3 Metre   | 3 Metre   | 3 Metre  | 3 Metre   | 3 Metre   |
| <b>Trunking</b>                   | CA3W  | CU2W  | DP3W   | ER3W  | EL3W  |
| Spare lid centre                  | CLL3W   |   | CLL3W  | CLL3W   | CLL3W   |
| Spare lid top                     | CAN3W   | CLL3W   | DPN3W  | DPN3W   | ELN3W   |
| Spare lid bottom                  | CAN3W   | DLN2W   | DPN3W  | ELN3W   | ELN3W   |
| Divider                           |   | CUD2W   |  |   |   |
| Spacing lid cover                 | CCS3W   | CCS3W   | CCS3W  | CCS3W   | CCS3W   |
| External angle                    | CAX3W   | CUXB2W  | DPX3W  | ERX3W   | ELX3W   |
| Internal angle                    | CAI3W   | CUIB2W  | DPI3W  | ERI3W   | ELI3W   |
| Flat angle both (riser / dropper) | CAF3W   | (CUF2RW<br>CUF2DW)  | DPF3W  | (ERF3CW<br>ERF3RW)  | ELF3W   |
| Flat tee (riser/dropper)          | CAT3W   | (CUT2RW<br>CUT2DW)  | DPT3W  | ERT3W   | ELT3W   |
| Joint cover (coupler)             | CAJ3W   | CUJ2W   | DPJ3W  | ERJ3W   | ELJ3W   |
| End cap/stop end (LH/RH)          | CAS3W   | (CUS2LW<br>CUS2RW)  | DPE3W  | (ERS3LW<br>ERS3RW)  | ELS3W   |
| Data cable guide (ext angle)      |   |   | DCGA   | DCGA  | DCGA  |
| Ultimate 60 to delta converter    | CAC3W   |   |  |   |   |
| Screening divider                 | SS60  | SS43  | SS34   | SS34  | SS34  |
| Screening divider - int/ext angle | SSI60 / SSX60   | SSI43 / SSX43   |  |   |   |
| Crossover unit                    |   |   | DLO3   | DLO3  | DLO3  |
| Cable hanger                      |   |   | CLH3   | CLH3  | CLH3  |
| Cable retainers centre            |   |   | DLC3M  | DLC3M   | DLC3M   |
| Cable retainers - chamfered outer |   |   | DPC3T  | DPC3T   |   |
| Cable retainers - radius outer    |   |   |  | DSC3T   | DSC3T   |
| Oval bell mouth bush              | BMB   | BMB   |  |   |   |
| Earth tags                        | SET1  | SET1  | SET1   | SET1  | SET1  |
| Mini trunking adapters 16 x 16mm  | CLA31W  | CLA31W  | CLA31W   | CLA31W  | CLA31W  |
| Mini trunking adapters 25 x 16mm  | CLA32W  | CLA32W  | CLA32W   | CLA32W  | CLA32W  |
| <b>Socket mounting boxes</b>      |   |   |  |   |   |
| 1G 25mm                           | CLB31W  | CLB31W  | CLB31W   | CLB31W  | CLB31W  |
| 1G 35mm                           | CLB41W  | CLB41W  | CLB41W   | CLB41W  | CLB41W  |
| 1G 50mm                           | CLB51W  | CLB51W  |  |   |   |
| 2G 25mm                           | CLB32W  | CLB32W  | CLB32W   | CLB32W  | CLB32W  |
| 2G 35mm                           | CLB42W  | CLB42W  | CLB42W   | CLB42W  | CLB42W  |
| 2G 50mm                           | CLB52W  | CLB52W  |  |   |   |
| <b>DDA plates</b>                 |   |   |  |   |   |
| DDA plate Blue 1G/2G              | DDA1BL<br>DDA2BL  | DDA1BL<br>DDA2BL  | DDA1BL<br>DDA2BL   | DDA1BL<br>DDA2BL  | DDA1BL<br>DDA2BL  |
| DDA plate Grey 1G/2G              | DDA1CH<br>DDA2CH  | DDA1CH<br>DDA2CH  | DDA1CH<br>DDA2CH   | DDA1CH<br>DDA2CH  | DDA1CH<br>DDA2CH  |
| DDA compliant lid                 | CLL3G   | CLL3G   | CLL3G  | CLL3G   | CLL3G   |

| Cableline duo  | Cableline 40  |   |   | Delta 105   | Carlton   |
|--|---|---|---|---|---|
|  |  |  |  |  |  |
| 2  | 3   | 3   | 3   | 1   | 2   |
| 210 x 52mm   | 145 x 40mm  | 145 x 40mm  | 145 x 40mm  | 100 x 50mm  | 80 x 22mm   |
| 3 Meter  | 3 Metre   | 3 Metre   | 3 Metre   | 3 Metre   | 3 Metre   |
| EP2W   | CP3W  | CS3W  | CL3W  | DA105W  | SK82W   |
| CLL3W  | CLL3W   | CLL3W   | CLL3W   |   |   |
|  | CSN3W   | CSN3W   | CLN3W   |   |   |
|  | CSN3W   | CLN3W   | CLN3W   |   |   |
| EPD2W  |   |   |   | DAHD105W  |   |
|  | CCS3W   | CCS3W   | CCS3W   |   |   |
| EPX2W  | CPX3W   | CSX3W   | CLX3W   | DAX105W   | SKE82W  |
| EPI2W  | CPI3W   | CSI3W   | CLI3W   | DAI105W   | SKI82W  |
| EPF2W  | CPF3W   | (CSF3CW<br>CSF3RW)  | CLF3W   | DAF105W   |   |
| EPT2W  | CPT3W   | (CST3CW<br>CST3RW)  | CLT3W   | DAT105W   |   |
| EPJ2W  | CPJ3W   | CSJ3W   | CLJ3W   | DAJ105W   | SKJ82W  |
| EPS2W  | CPS3W   | (CSS3LW<br>CSS3RW)  | CLS3W/ CLE3W  | DAS105W   | (SKL82W<br>SKR82W)  |
| DCGA   |   |   |   |   |   |
|  |   |   |   |   |   |
| SS34   | SS23  | SS23  | SS23  | SS105<br>SSI105 / SSX105  |   |
| DLO3   | CLO3  | CLO3  | CLO3  |   | SKC82W  |
| CLH3   | CLH3  | CLH3  | CLH3  |   |   |
| DLC3M  | CLC3M   | CLC3M   | CLC3M   |   |   |
|  | CSC3T   | CSC3T   |   |   |   |
|  |   | CLC3T   | CLC3T   |   |   |
|  |   |   |   |   |   |
| SET1   | SET1  | SET1  | SET1  | SET1  |   |
| CLA31W   | CLA31W  | CLA31W  | CLA31W  | MFC1W   |   |
| CLA32W   | CLA32W  | CLA32W  | CLA32W  | MFC2W   | SKM822W   |
|  | CLB31W  | CLB31W  | CLB31W  | CTB11W<br>CTB21W  | SKB21W (external)   |
|  |   |   |   |   |   |
| CLB32W   | CLB32W  | CLB32W  | CLB32W  | CTB12W  |   |
| CLB42W   |   |   |   | CTB22W  | SKB22W (external)   |
|  |   |   |   |   |   |
| DDA1BL   | DDA1BL  | DDA1BL  | DDA1BL  | DDA1BL  |   |
| DDA2BL   | DDA2BL  | DDA2BL  | DDA2BL  | DDA2BL  |   |
| DDA1CH   | DDA1CH  | DDA1CH  | DDA1CH  | DDA1CH  |   |
| DDA2CH   | DDA2CH  | DDA2CH  | DDA2CH  | DDA2CH  |   |
| CLL3G  | CLL3G   | CLL3G   | CLL3G   | CLL3G   |   |

# Consort Delta 105

Consort Delta 105, with dimensions of 100 x 50mm is a single compartment uPVC trunking with a stylish profile.

Delta 105 has been designed for use in power and high density CAT5e and CAT6 structured cabling installations. Delta 105 has a contemporary look and the trunking features adjustable bends and a multi-configurable tee.



**Cat 6 Compliancy**  
 The Consort Delta 105 trunking system accommodates high density data installations with a depth of 50mm holding up to 59 UTP or 41 STP data cables in the centre compartment.

### Technical data

- Material: uPVC
- Colour: white
- 3m lengths
- 100 x 50mm trunking with a contemporary look
- Adjustable bends allow movement +/- 5°
- Multi-configurable tee allowing for 50mm bend radius to be maintained
- Clip on fittings
- Accommodates socket mounting boxes up to 35mm deep
- Steel screening divider where required
- Meets and exceeds requirements of European and International Data Standards
- BS EN 50085-1, BS EN 50085-2-1, BS4678 Pt4, BS7671 (IET Regulations), BS6701, BS EN 50173-1, BS EN 50174-2, ANSI/TIA/EIA568B & ISO/IEC11801
- Antimicrobial available

### Trunking assemblies

| Ref    |                      | Packed |
|--------|----------------------|--------|
| DA105W | Divider not included | 2 x 3m |

### Divider

| Ref      |  | Packed |
|----------|--|--------|
| DAHD105W |  | 24m    |

### External angle - adjustable (+/-5°)

| Ref     |  | Packed |
|---------|--|--------|
| DAX105W |  | 1      |

### Internal angle - adjustable (+/-5°)

| Ref     |  | Packed |
|---------|--|--------|
| DAI105W |  | 1      |

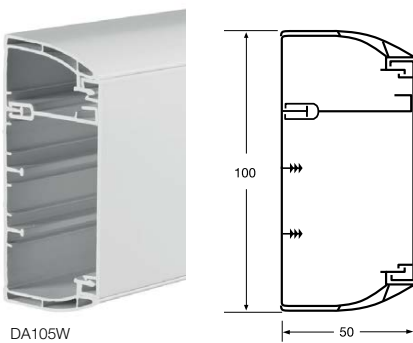

Part M - DDA compliant

Antimicrobial available