







Cableline duo	Cableline 40			Delta 105	Carlton
					
2	3	3	3	1	2
210 x 52mm	145 x 40mm	145 x 40mm	145 x 40mm	100 x 50mm	80 x 22mm
3 Meter	3 Metre	3 Metre	3 Metre	3 Metre	3 Metre
EP2W	CP3W	CS3W	CL3W	DA105W	SK82W
CLL3W	CLL3W	CLL3W	CLL3W		
	CSN3W	CSN3W	CLN3W		
	CSN3W	CLN3W	CLN3W		
EPD2W				DAHD105W	
	CCS3W	CCS3W	CCS3W		
EPX2W	CPX3W	CSX3W	CLX3W	DAX105W	SKE82W
EPI2W	CPI3W	CSI3W	CLI3W	DAI105W	SKI82W
EPF2W	CPF3W	(CSF3CW CSF3RW)	CLF3W	DAF105W	
EPT2W	CPT3W	(CST3CW CST3RW)	CLT3W	DAT105W	
EPJ2W	CPJ3W	CSJ3W	CLJ3W	DAJ105W	SKJ82W
EPS2W	CPS3W	(CSS3LW CSS3RW)	CLS3W/ CLE3W	DAS105W	(SKL82W SKR82W)
DCGA					
SS34	SS23	SS23	SS23	SS105 SSI105 / SSX105	
DLO3	CLO3	CLO3	CLO3		SKC82W
CLH3	CLH3	CLH3	CLH3		
DLC3M	CLC3M	CLC3M	CLC3M		
	CSC3T	CSC3T			
		CLC3T	CLC3T		
SET1	SET1	SET1	SET1	SET1	
CLA31W	CLA31W	CLA31W	CLA31W	MFC1W	
CLA32W	CLA32W	CLA32W	CLA32W	MFC2W	SKM822W
	CLB31W	CLB31W	CLB31W	CTB11W CTB21W	SKB21W (external)
CLB32W	CLB32W	CLB32W	CLB32W	CTB12W	
CLB42W				CTB22W	SKB22W (external)
DDA1BL DDA2BL	DDA1BL DDA2BL	DDA1BL DDA2BL	DDA1BL DDA2BL	DDA1BL DDA2BL	
DDA1CH DDA2CH	DDA1CH DDA2CH	DDA1CH DDA2CH	DDA1CH DDA2CH	DDA1CH DDA2CH	
CLL3G	CLL3G	CLL3G	CLL3G	CLL3G	

Consort Delta 105

Consort Delta 105, with dimensions of 100 x 50mm is a single compartment uPVC trunking with a stylish profile.

Delta 105 has been designed for use in power and high density CAT5e and CAT6 structured cabling installations. Delta 105 has a contemporary look and the trunking features adjustable bends and a multi-configurable tee.



Cat 6 Compliancy
The Consort Delta 105 trunking system accommodates high density data installations with a depth of 50mm holding up to 59 UTP or 41 STP data cables in the centre compartment.

Technical data

- Material: uPVC
- Colour: white
- 3m lengths
- 100 x 50mm trunking with a contemporary look
- Adjustable bends allow movement +/- 5°
- Multi-configurable tee allowing for 50mm bend radius to be maintained
- Clip on fittings
- Accommodates socket mounting boxes up to 35mm deep
- Steel screening divider where required
- Meets and exceeds requirements of European and International Data Standards
- BS EN 50085-1, BS EN 50085-2-1, BS4678 Pt4, BS7671 (IET Regulations), BS6701, BS EN 50173-1, BS EN 50174-2, ANSI/TIA/EIA568B & ISO/IEC11801
- Antimicrobial available

Trunking assemblies

Ref		Packed
DA105W	Divider not included	2 x 3m

Divider

Ref		Packed
DAHD105W		24m

External angle - adjustable (+/-5°)

Ref		Packed
DAX105W		1

Internal angle - adjustable (+/-5°)

Ref		Packed
DAI105W		1

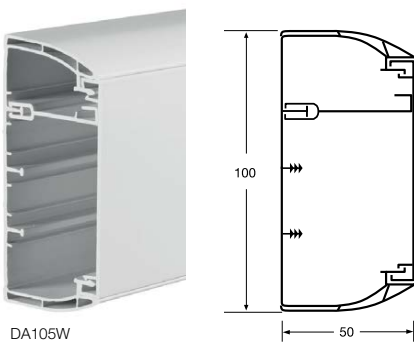

DA105W



Part M - DDA compliant

Antimicrobial available