

Soporte 60 | *Side Support 60* | *Support 60*

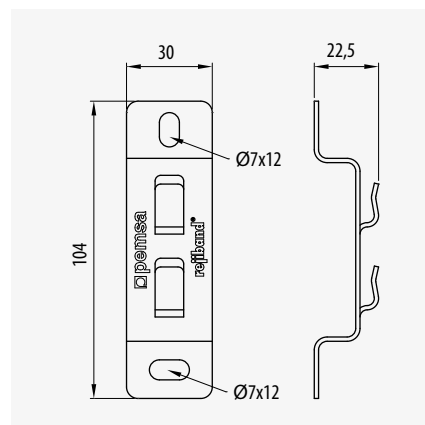

	Ref	kg/u	u
EZ	62011060	0,042	25
BC	62021060	0,042	25
GC	62031060	0,044	25
C8	62081060	0,044	25
316L	62061060	0,042	25

Suspensión Central Click | *Click Central Suspension* | *Suspension Central Click*

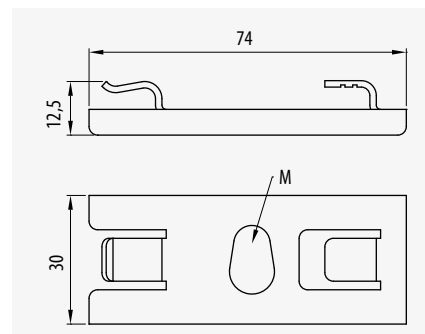

	M	Ref	kg/u	u
EZ	M6	67010143	0,046	20
	M8/M10	67010043	0,045	20
BC	M6	67020143	0,046	20
	M8/M10	67020043	0,045	20
GC	M6	67030143	0,048	20
	M8/M10	67030043	0,048	20
C8	M6	67080143	0,046	20
	M8/M10	67080043	0,045	20
316L	M6	67060143	0,045	20
	M8/M10	67060043	0,045	20

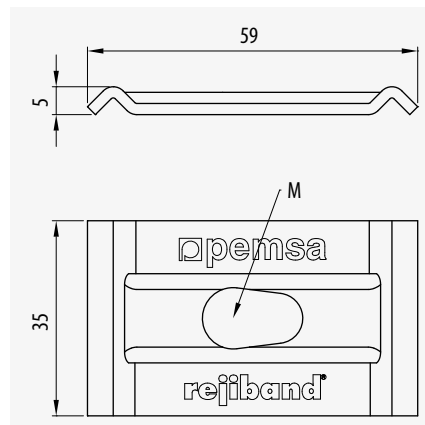

Suspensión Central | *Central Hanging Plate* | *Suspension Central*

	M	Ref	kg/u	u
EZ	M6	67010144	0,033	20
	M8/M10	67010046	0,033	20
BC	M8/M10	67020046	0,030	20
	M6	67030144	0,032	20
GC	M8/M10	67030046	0,032	20
	M8/M10	67080046	0,030	20
316L	M8/M10	67060046	0,031	20

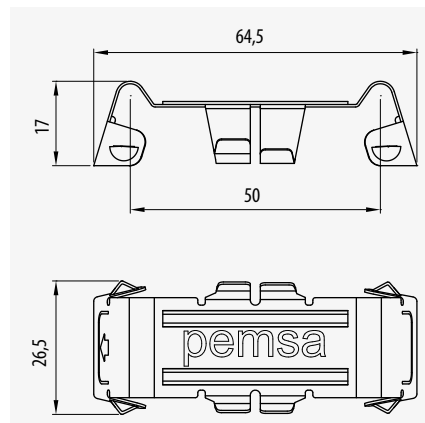

Clip Fijación Rail | *Strut Clip* | *Fixation Rapide Click Rail 41*

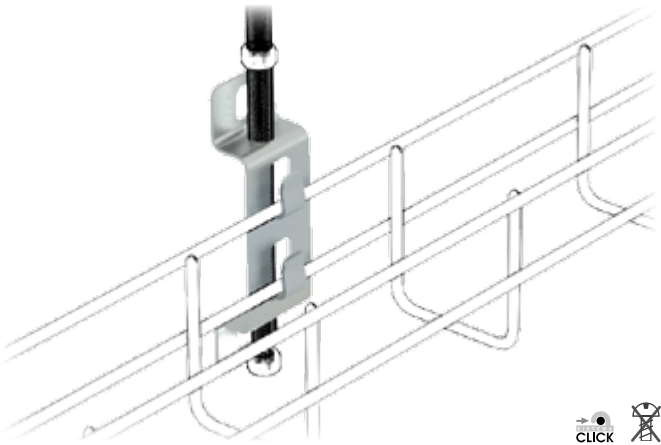
	Ref	kg/u	u
316L	67060050	0,008	100



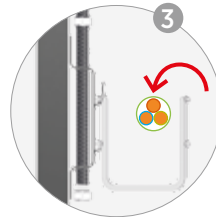
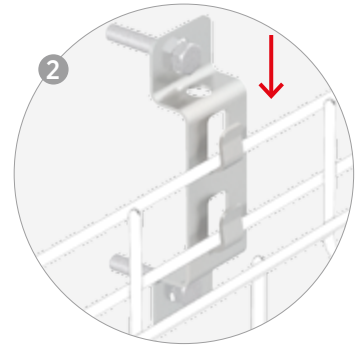
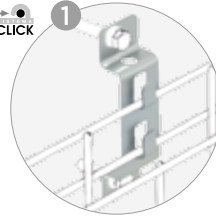

click





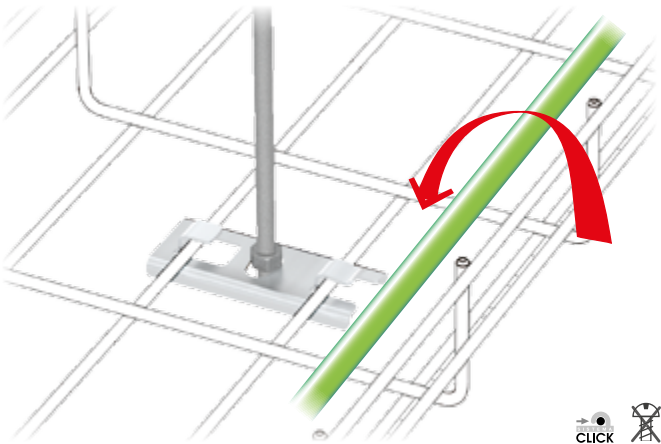



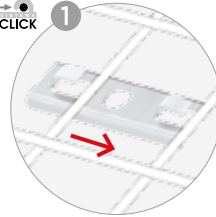

click



click



-  x 1   040
-  x 2   167
-  x 1   148

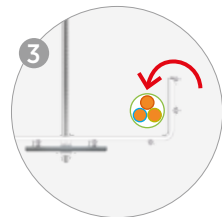
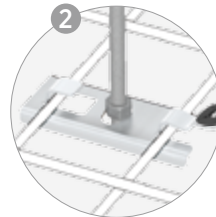



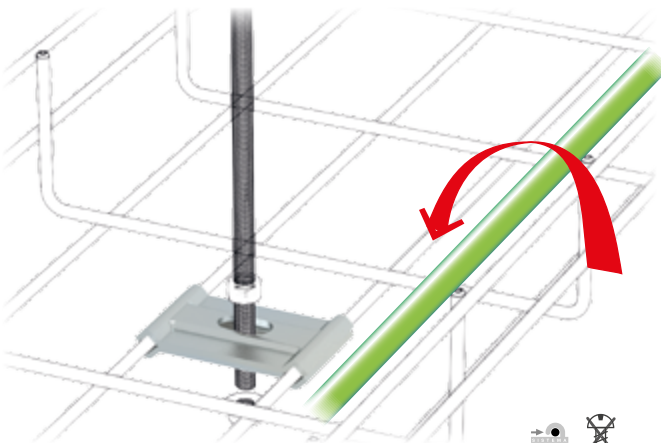



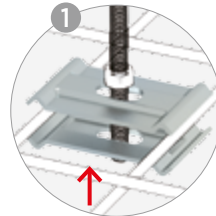

click



click



-  x 2   040
-  x 2   167
-  x 1   148

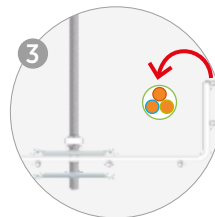
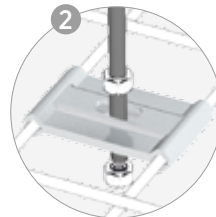

click

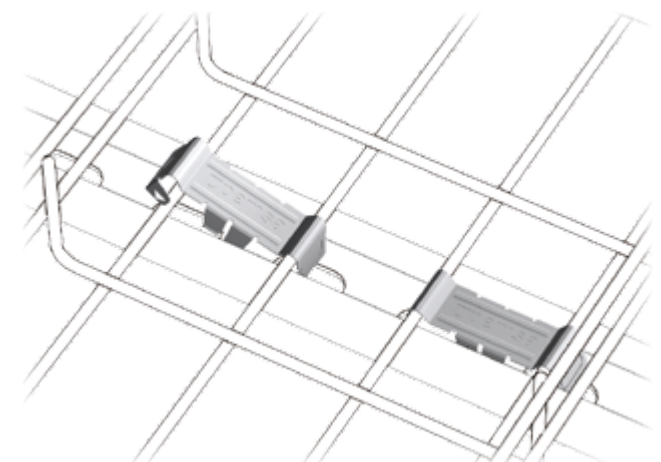

click

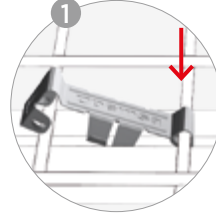

Montaje Rail 41x41 y 41x21
Assembly on strut 41x41 and 41x21
Montage Rail 41x41 e 41x21

Rápido y Seguro!!
Fast and Safe
Rapide et Efficace

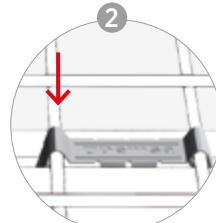

Compatible con cualquier modelo
Compatible with any brand
Compatible tous modèles