

# AF and EK 4-pole contactors

## 3/148 Overview

### Ordering details

#### 25 to 125 A AC-1

3/150	AF09 ... AF38	AC / DC operated
3/151	AF09Z ... AF16Z	24 V DC operated designed for PLC
3/152	AF09Z ... AF38Z	AC / DC operated for specific applications
3/153	AF40 ... AF80	AC / DC operated
3/151	Contactors and main accessories	

#### 160 to 525 A AC-1

3/155	AF116 ... AF140	AC / DC operated
3/156	AF190 ... AF370	AC / DC operated
3/157	Contactors and main accessories	
3/158	AF116 ... AF140	AC / DC operated - with 1 N.O. + 1 N.C.
3/159	AF190 ... AF370	AC / DC operated - with 1 N.O. + 1 N.C.
3/160	Contactors and main accessories	
3/161	AF116 ... AF140	AC / DC operated - with 2 N.O. + 2 N.C.
3/162	AF190 ... AF370	AC / DC operated - with 2 N.O. + 2 N.C.
3/163	Contactors and main accessories	

#### 800 to 1000 A AC-1

3/164	EK550, EK1000	AC operated - with 1 N.O. + 1 N.C.
3/165	EK550, EK1000	DC operated - with 2 N.O. + 1 N.C.
3/166	EK550, EK1000	AC operated - with 2 N.O. + 2 N.C.
3/167	Main accessories	

## 3/169 Technical data

## 3/181 Electrical durability

## 3/440 Voltage code table





For direct product details information, use product type or order code, ex:

- [www.abb.com/productdetails/AF09-30-10-13](http://www.abb.com/productdetails/AF09-30-10-13)
- or [www.abb.com/productdetails/1SBL137001R1310](http://www.abb.com/productdetails/1SBL137001R1310)

## 4-pole contactors



IEC	AC-1 Rated operational current	$\theta \leq 40\text{ }^{\circ}\text{C}$ , 690 V	A	25	30	45	55	70	100	125
UL/CSA	General use rating	600 V	A	25	30	45	55	60	80	105
AC / DC Control supply			Type	<b>AF09</b>	<b>AF16</b>	<b>AF26</b>	<b>AF38</b>	<b>AF40</b>	<b>AF52</b>	<b>AF80</b>
AC Control supply			Type	<b>AF09</b>	<b>AF16</b>	<b>AF26</b>	<b>AF38</b>	<b>AF40</b>	<b>AF52</b>	<b>AF80</b>
DC Control supply			Type	<b>AF09</b>	<b>AF16</b>	<b>AF26</b>	<b>AF38</b>	<b>AF40</b>	<b>AF52</b>	<b>AF80</b>
IEC	AC-1 Rated operational current	$\theta \leq 40\text{ }^{\circ}\text{C}$	A	25	30	45	55	70	100	125
	690 V	$\theta \leq 60\text{ }^{\circ}\text{C}$ (1)	A	25	30	40	45	60	80	105
		$\theta \leq 70\text{ }^{\circ}\text{C}$	A	22	26	32	37	50	70	90
	With conductor cross sectional area		mm <sup>2</sup>	4	6	10	16	35	35	50
	Rated operational voltage Ue max.		V	690	690	690	690	690	690	690

(1)  $\theta \leq 55\text{ }^{\circ}\text{C}$  for EK550, EK1000 contactors

### Main accessories

Auxiliary contact blocks	Front mounting
	Side mounting
Timers	Electronic
Interlocking units	Mechanical
	Mechanical / Electrical
Surge suppressors	Varistor + RC (AC / DC)

<b>CA4-10</b> (1 x N.O.), <b>CA4-01</b> (1 x N.C.)	
<b>CAL4-11</b> (1 x N.O. + 1 x N.C.)	
<b>TEF4-ON</b> <b>TEF4-OFF</b>	
<b>VM4</b>	<b>VM96-4</b>
<b>VEM4</b>	
Built-in surge protection	



160	200	275	350	400	500	525	800	1000
160	175	230	250	300	350	420	540	—
<b>AF116</b>	<b>AF140</b>	<b>AF190</b>	<b>AF205</b>	<b>AF265</b>	<b>AF305</b>	<b>AF370</b>	—	—
<b>AF116</b>	<b>AF140</b>	<b>AF190</b>	<b>AF205</b>	<b>AF265</b>	<b>AF305</b>	<b>AF370</b>	<b>EK550</b>	<b>EK1000</b>
<b>AF116</b>	<b>AF140</b>	<b>AF190</b>	<b>AF205</b>	<b>AF265</b>	<b>AF305</b>	<b>AF370</b>	<b>EK550</b>	<b>EK1000</b>
160	200	275	350	400	500	525	800	1000
145	175	250	300	350	400	425	650	800
130	160	200	240	290	325	350	575	720
70	95	150	240	240	300	2 x 185	2 x 240	2 x 300
690	690	1000	1000	1000	1000	1000	1000	1000

<b>CAL19-11</b> (1 x N.O. + 1 x N.C.)	<b>CAL16-11</b> (1 x N.O. + 1 x N.C.)
<b>VM19</b> (for same size contactors)	<b>VH800</b>
	<b>RC-EH800</b>

03

# AF09 ... AF38 4-pole contactors

25 to 55 A AC-1  
AC / DC operated



AF09-40-00



AF26-40-00

AF09 ... AF38 4-pole contactors are mainly used for controlling non-inductive or slightly inductive loads (i.e. resistance furnaces...) and generally for controlling power circuits up to 690 V AC and 440 V DC. These contactors are of the block type design with 4 main poles.

- control circuit: AC or DC operated with electronic coil interface accepting a wide control voltage range (e.g. 100...250 V AC and DC), only 4 control voltage ranges covering 24...500 V 50/60 Hz and 20...500 V DC
  - can manage large control voltage variations
  - reduced panel energy consumption
  - very distinct closing and opening.
- built-in surge suppression
- add-on auxiliary contact blocks for front or side mounting and a wide range of accessories.

IEC	UL/CSA	Rated control circuit voltage Uc min. ... Uc max.		Auxiliary contacts fitted	Type	Order code	Weight
Rated operational current $\theta \leq 40^\circ\text{C}$ AC-1	General use rating 600 V AC						Pkg (1 pce) kg
A	A	V 50/60 Hz	V DC				
<b>4 N.O. main poles</b>							
25	25	24...60	20...60 (1)	0 0	AF09-40-00-11	1SBL137201R1100	0.270
		48...130	48...130	0 0	AF09-40-00-12	1SBL137201R1200	0.270
		100...250	100...250	0 0	AF09-40-00-13	1SBL137201R1300	0.270
		250...500	250...500	0 0	AF09-40-00-14	1SBL137201R1400	0.310
30	30	24...60	20...60 (1)	0 0	AF16-40-00-11	1SBL177201R1100	0.270
		48...130	48...130	0 0	AF16-40-00-12	1SBL177201R1200	0.270
		100...250	100...250	0 0	AF16-40-00-13	1SBL177201R1300	0.270
		250...500	250...500	0 0	AF16-40-00-14	1SBL177201R1400	0.310
45	45	24...60	20...60 (1)	0 0	AF26-40-00-11	1SBL237201R1100	0.360
		48...130	48...130	0 0	AF26-40-00-12	1SBL237201R1200	0.360
		100...250	100...250	0 0	AF26-40-00-13	1SBL237201R1300	0.360
		250...500	250...500	0 0	AF26-40-00-14	1SBL237201R1400	0.400
55	55	24...60	20...60 (1)	0 0	AF38-40-00-11	1SBL297201R1100	0.360
		48...130	48...130	0 0	AF38-40-00-12	1SBL297201R1200	0.360
		100...250	100...250	0 0	AF38-40-00-13	1SBL297201R1300	0.360
		250...500	250...500	0 0	AF38-40-00-14	1SBL297201R1400	0.400
<b>2 N.O. + 2 N.C. main poles</b>							
25	25	24...60	20...60 (1)	0 0	AF09-22-00-11	1SBL137501R1100	0.270
		48...130	48...130	0 0	AF09-22-00-12	1SBL137501R1200	0.270
		100...250	100...250	0 0	AF09-22-00-13	1SBL137501R1300	0.270
		250...500	250...500	0 0	AF09-22-00-14	1SBL137501R1400	0.310
30	30	24...60	20...60 (1)	0 0	AF16-22-00-11	1SBL177501R1100	0.270
		48...130	48...130	0 0	AF16-22-00-12	1SBL177501R1200	0.270
		100...250	100...250	0 0	AF16-22-00-13	1SBL177501R1300	0.270
		250...500	250...500	0 0	AF16-22-00-14	1SBL177501R1400	0.310
45	45	24...60	20...60 (1)	0 0	AF26-22-00-11	1SBL237501R1100	0.360
		48...130	48...130	0 0	AF26-22-00-12	1SBL237501R1200	0.360
		100...250	100...250	0 0	AF26-22-00-13	1SBL237501R1300	0.360
		250...500	250...500	0 0	AF26-22-00-14	1SBL237501R1400	0.400
55	55	24...60	20...60 (1)	0 0	AF38-22-00-11	1SBL297501R1100	0.360
		48...130	48...130	0 0	AF38-22-00-12	1SBL297501R1200	0.360
		100...250	100...250	0 0	AF38-22-00-13	1SBL297501R1300	0.360
		250...500	250...500	0 0	AF38-22-00-14	1SBL297501R1400	0.400

(1) AF...-40-...-11 and AF...-22-...-11 not suitable for direct control by PLC-output.

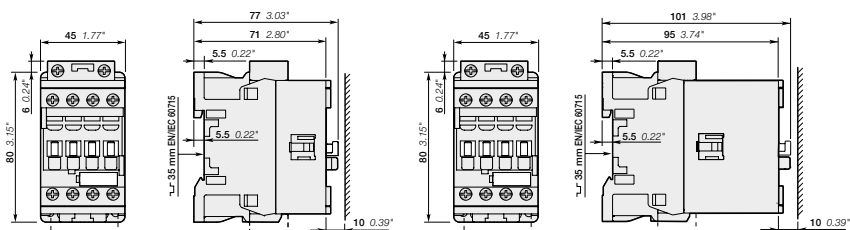

AF09, AF16

AF26, AF38

Main dimensions mm, inches

# AF09Z ... AF16Z 4-pole contactors

25 to 30 A AC-1

24 V DC operated designed for PLC

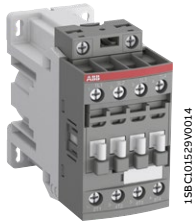

AF09Z-40-00

AF09Z ... AF16Z 4-pole contactors are mainly used for controlling non-inductive or slightly inductive loads (i.e. resistance furnaces...) and generally for controlling power circuits up to 690 V AC and 440 V DC. These contactors are of the block type design with 4 main poles.

- control circuit: 24 V DC operated with electronic coil interface allowing low holding consumption up to 1.7 W and reduced panel energy consumption
  - allow direct control by PLC-output  $\geq 250$  mA 24 V DC
  - very distinct closing and opening
- built-in surge suppression
- add-on auxiliary contact blocks for front or side mounting and a wide range of accessories.

IEC	UL/CSA	Rated control circuit voltage Uc	Auxiliary contacts fitted	Type	Order code	Weight
Rated operational current $\theta \leq 40^\circ\text{C}$ AC-1 A	General use rating 600 V AC A	V DC				Pkg (1 pce) kg

### 4 N.O. main poles

Rated current (A)	UL/CSA rating (A)	Rated control circuit voltage (V DC)	Auxiliary contacts	Type	Order code	Weight (kg)
25	25	24	0 0	AF09Z-40-00-30	1SBL136201R3000	0.430
30	30	24	0 0	AF16Z-40-00-30	1SBL176201R3000	0.430

### 2 N.O. + 2 N.C. main poles

Rated current (A)	UL/CSA rating (A)	Rated control circuit voltage (V DC)	Auxiliary contacts	Type	Order code	Weight (kg)
25	25	24	0 0	AF09Z-22-00-30	1SBL136501R3000	0.430
30	30	24	0 0	AF16Z-22-00-30	1SBL176501R3000	0.430

Note: AF..Z contactors with 24 V DC control voltage need to respect the connection polarities indicated close to the coil terminals: A1+ for the positive pole and A2- for the negative pole.

### Main dimensions mm, inches

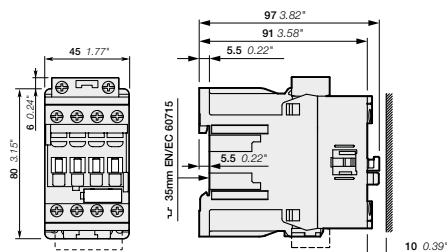

AF09Z, AF16Z

# AF09Z ... AF38Z 4-pole contactors

25 to 55 A AC-1

AC / DC operated for specific applications



AF09Z-40-00



AF26Z-40-00

AF09Z ... AF38Z 4-pole contactors are mainly used for controlling non-inductive or slightly inductive loads (i.e. resistance furnaces...) and generally for controlling power circuits up to 690 V AC and 440 V DC. These contactors are of the block type design with 4 main poles.

- control circuit: AC or DC operated with electronic coil interface accepting a wide control voltage range (e.g. 100...250 V AC and DC), only 4 control voltage ranges covering 24...250 V 50/60 Hz and 12...250 V DC
  - can manage large control voltage variations
  - allow direct control by PLC-output  $\geq 24$  V DC 500 mA
  - reduced panel energy consumption
  - very distinct closing and opening
  - can withstand short voltage dips and voltage sags (SEMI F47-0706 conditions of use on request).
- built-in surge suppression
- add-on auxiliary contact blocks for front or side mounting and a wide range of accessories.

IEC	UL/CSA	Rated control circuit voltage Uc min. ... Uc max.	Auxiliary contacts fitted	Type	Order code	Weight Pkg (1 pce) kg
Rated operational current $\theta \leq 40^\circ\text{C}$ AC-1	General use rating 600 V AC	V 50/60 Hz   V DC				
A	A					

### 4 N.O. main poles

Rated current	UL/CSA	Uc min.	Uc max.	Auxiliary contacts	Type	Order code	Weight
25	25	-	12...20	0 0	AF09Z-40-00-20	1SBL136201R2000	0.310
		24...60	20...60	0 0	AF09Z-40-00-21	1SBL136201R2100	0.310
		48...130	48...130	0 0	AF09Z-40-00-22	1SBL136201R2200	0.310
		100...250	100...250	0 0	AF09Z-40-00-23	1SBL136201R2300	0.310
30	30	-	12...20	0 0	AF16Z-40-00-20	1SBL176201R2000	0.310
		24...60	20...60	0 0	AF16Z-40-00-21	1SBL176201R2100	0.310
		48...130	48...130	0 0	AF16Z-40-00-22	1SBL176201R2200	0.310
		100...250	100...250	0 0	AF16Z-40-00-23	1SBL176201R2300	0.310
45	45	-	12...20	0 0	AF26Z-40-00-20	1SBL236201R2000	0.400
		24...60	20...60	0 0	AF26Z-40-00-21	1SBL236201R2100	0.400
		48...130	48...130	0 0	AF26Z-40-00-22	1SBL236201R2200	0.400
		100...250	100...250	0 0	AF26Z-40-00-23	1SBL236201R2300	0.400
55	55	-	12...20	0 0	AF38Z-40-00-20	1SBL296201R2000	0.400
		24...60	20...60	0 0	AF38Z-40-00-21	1SBL296201R2100	0.400
		48...130	48...130	0 0	AF38Z-40-00-22	1SBL296201R2200	0.400
		100...250	100...250	0 0	AF38Z-40-00-23	1SBL296201R2300	0.400

### 2 N.O. + 2 N.C. main poles

Rated current	UL/CSA	Uc min.	Uc max.	Auxiliary contacts	Type	Order code	Weight
25	25	-	12...20	0 0	AF09Z-22-00-20	1SBL136501R2000	0.310
		24...60	20...60	0 0	AF09Z-22-00-21	1SBL136501R2100	0.310
		48...130	48...130	0 0	AF09Z-22-00-22	1SBL136501R2200	0.310
		100...250	100...250	0 0	AF09Z-22-00-23	1SBL136501R2300	0.310
30	30	-	12...20	0 0	AF16Z-22-00-20	1SBL176501R2000	0.310
		24...60	20...60	0 0	AF16Z-22-00-21	1SBL176501R2100	0.310
		48...130	48...130	0 0	AF16Z-22-00-22	1SBL176501R2200	0.310
		100...250	100...250	0 0	AF16Z-22-00-23	1SBL176501R2300	0.310
45	45	-	12...20	0 0	AF26Z-22-00-20	1SBL236501R2000	0.400
		24...60	20...60	0 0	AF26Z-22-00-21	1SBL236501R2100	0.400
		48...130	48...130	0 0	AF26Z-22-00-22	1SBL236501R2200	0.400
		100...250	100...250	0 0	AF26Z-22-00-23	1SBL236501R2300	0.400
55	55	-	12...20	0 0	AF38Z-22-00-20	1SBL296501R2000	0.400
		24...60	20...60	0 0	AF38Z-22-00-21	1SBL296501R2100	0.400
		48...130	48...130	0 0	AF38Z-22-00-22	1SBL296501R2200	0.400
		100...250	100...250	0 0	AF38Z-22-00-23	1SBL296501R2300	0.400

Note: Only AF..Z contactors with DC control voltage 12...20 V DC need to respect the connection polarities indicated close to the coil terminals: A1+ for the positive pole and A2- for the negative pole.

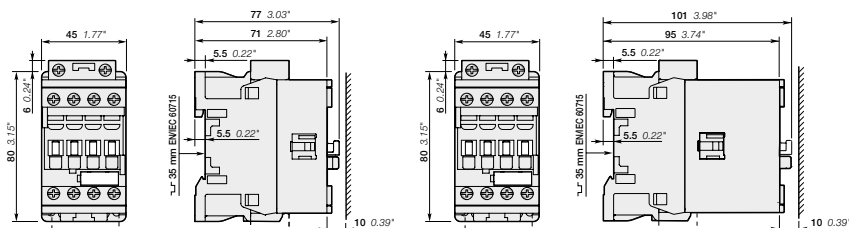

AF09Z, AF16Z

AF26Z, AF38Z

Main dimensions mm, inches

# AF40 ... AF80 4-pole contactors

70 to 125 A AC-1  
AC / DC operated



AF40-40-00

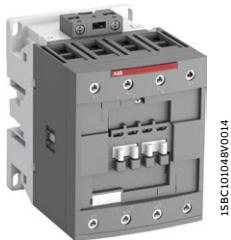

AF80-40-00

AF40 ... AF80 4-pole contactors are mainly used for controlling non-inductive or slightly inductive loads (i.e. resistance furnaces...) and generally for controlling power circuits up to 1000 V AC and 440 V DC. These contactors are of the block type design with 4 main poles.

- control circuit: AC or DC operated with electronic coil interface accepting a wide control voltage range (e.g. 100...250 V AC and DC), only 4 control voltages ranges covering 24...500 V 50/60 Hz and 20...500 V DC
  - can manage large control voltage variations
  - reduced panel energy consumption
  - very distinct closing and opening
  - can withstand short voltage dips and voltage sags (SEMI F47-0706 conditions of use on request).
- built-in surge suppression
- add-on auxiliary contact blocks for front or side mounting and a wide range of accessories.

IEC Rated operational current $\theta \leq 40^\circ\text{C}$ AC-1	UL/CSA General use rating 600 V AC  A	Rated control circuit voltage Uc min. ... Uc max.		Auxiliary contacts fitted  ⎓ ⎓	Type	Order code	Weight  Pkg (1 pce)  kg
		V 50/60 Hz	V DC				

### 4 N.O. main poles

70	60	24...60	20...60	0 0	AF40-40-00-11	1SBL347201R1100	1.210
		48...130	48...130	0 0	AF40-40-00-12	1SBL347201R1200	1.210
		100...250	100...250	0 0	AF40-40-00-13	1SBL347201R1300	1.160
		250...500	250...500	0 0	AF40-40-00-14	1SBL347201R1400	1.160
100	80	24...60	20...60	0 0	AF52-40-00-11	1SBL367201R1100	1.210
		48...130	48...130	0 0	AF52-40-00-12	1SBL367201R1200	1.210
		100...250	100...250	0 0	AF52-40-00-13	1SBL367201R1300	1.160
		250...500	250...500	0 0	AF52-40-00-14	1SBL367201R1400	1.160
125	105	24...60	20...60	0 0	AF80-40-00-11	1SBL397201R1100	1.490
		48...130	48...130	0 0	AF80-40-00-12	1SBL397201R1200	1.490
		100...250	100...250	0 0	AF80-40-00-13	1SBL397201R1300	1.440
		250...500	250...500	0 0	AF80-40-00-14	1SBL397201R1400	1.440

### 2 N.O. + 2 N.C. main poles

70	60	24...60	20...60	0 0	AF40-22-00-11	1SBL347501R1100	1.210
		48...130	48...130	0 0	AF40-22-00-12	1SBL347501R1200	1.210
		100...250	100...250	0 0	AF40-22-00-13	1SBL347501R1300	1.160
		250...500	250...500	0 0	AF40-22-00-14	1SBL347501R1400	1.160
125	105	24...60	20...60	0 0	AF80-22-00-11	1SBL397501R1100	1.490
		48...130	48...130	0 0	AF80-22-00-12	1SBL397501R1200	1.490
		100...250	100...250	0 0	AF80-22-00-13	1SBL397501R1300	1.440
		250...500	250...500	0 0	AF80-22-00-14	1SBL397501R1400	1.440

For control by PLC-output, use RA4 interface relay.

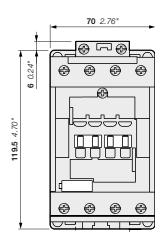

AF40, AF52

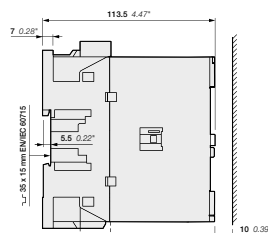

Main dimensions mm, inches

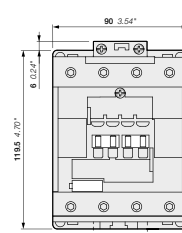

AF80

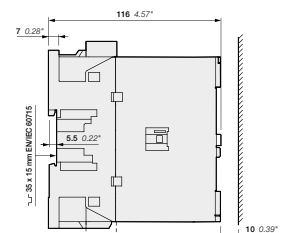

# AF09 ... AF80 4-pole contactors

## Contactors and main accessories

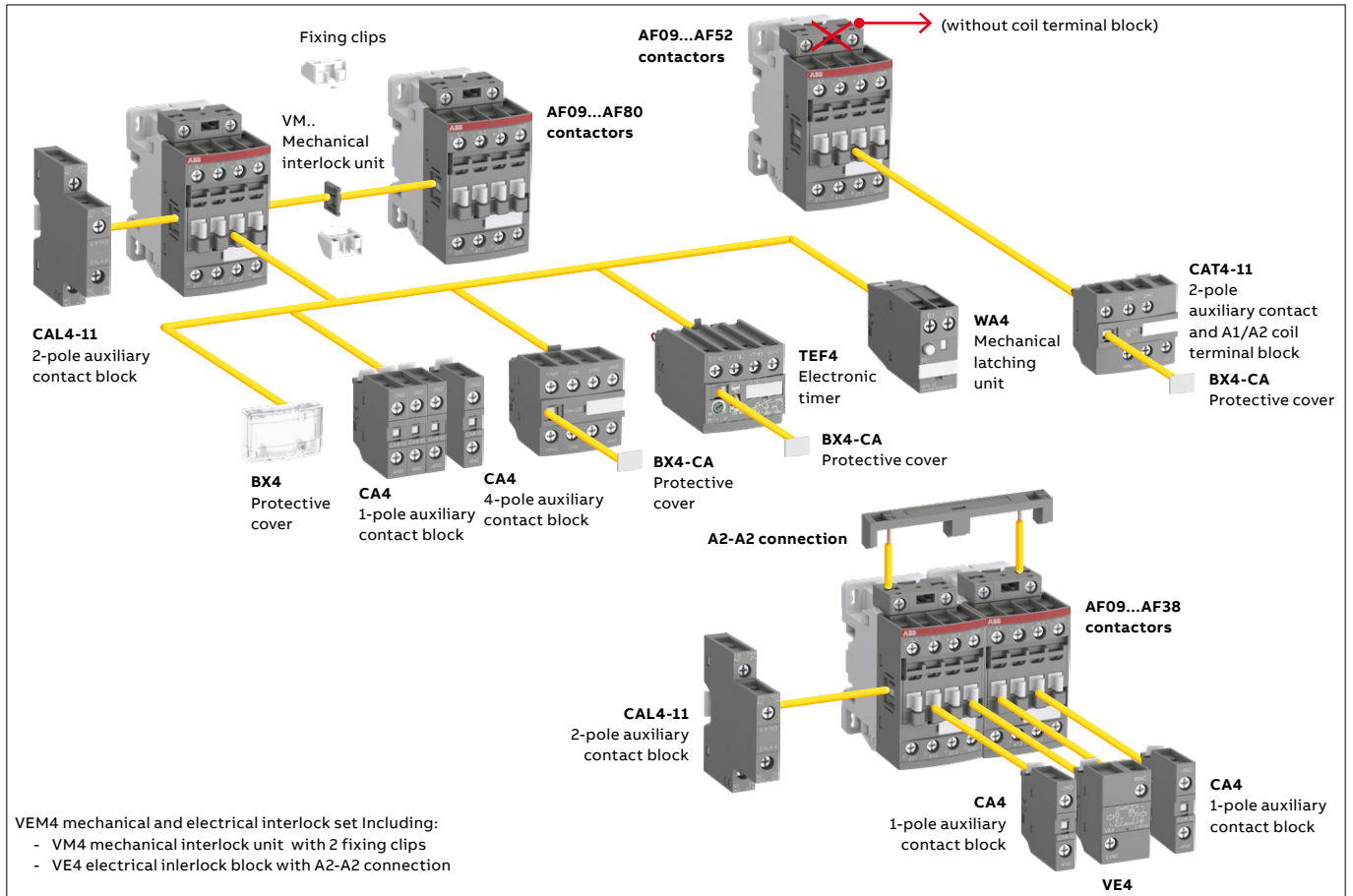

**Main accessory fitting details** - for ordering details, technical data and other accessories: see section accessories  
 Many configurations of accessories are possible depending on whether these are front-mounted or side-mounted.

Contactor types	Main poles	Built-in auxiliary contacts	Front-mounted accessories			Electronic timer	Mechanical latching unit	Electrical and mechanical interlock set (between 2 contactors)	Side-mounted accessories	
			Auxiliary contact blocks						Auxiliary contact blocks	
			1-pole CA4	2-pole CAT4-11	4-pole CA4	TEF4	WA4 (4)	VEM4	Left side	Right side
<b>AF09(Z) ... AF38(Z)</b>										
AF09 ... AF16	4 0	0 0(1)	4 max.	or 1	or 1	or 1	or 1	-	+ 1	-
AF26 ... AF38	4 0	0 0(2)	2 max.	or 1	-	or 1	or 1	-	+ 1	+ 1
			3 max.	-	-	-	-	+ 1 (5)	+ 1	or 1
AF09 ... AF38	2 2	0 0(2)	4 max.	or 1	or 1	or 1	or 1	-	+ 1	-
			2 max.	or 1	-	or 1	or 1	-	+ 1	+ 1
<b>AF09Z ... AF16Z 24 V DC designed for PLC - coil 30</b>										
AF09Z ... AF16Z	4 0	0 0(1)	4 max.	-	or 1	or 1	-	-(5)	or 1	+ 1
			2 max.	-	-	or 1	-	-(5)	+ 1	or 1
			-	-	-	1	-	-	+ 1	+ 1
AF09Z ... AF16Z	2 2	0 0(2)	4 max.	-	or 1	or 1	-	-	or 1	+ 1
			2 max.	-	-	or 1	-	-	+ 1	or 1
			-	-	-	1	-	-	+ 1	+ 1
<b>AF40 ... AF80</b>										
AF40 ... AF52	4 0	0 0	4 max.	or 1	or 1	or 1	or 1	-	+ 1	+ 1
AF80	4 0	0 0	4 max.	-	or 1	or 1	or 1	-	+ 1	+ 1
AF40	2 2	0 0(3)	4 max.	or 1	or 1	or 1	or 1	-	+ 1	-
			4 max.	-	or 1	or 1	or 1	-	+ 1	+ 1
AF80	2 2	0 0(3)	4 max.	-	or 1	or 1	or 1	-	+ 1	+ 1

(1) Including add-on contacts: 4 N.C. auxiliary contacts max. on positions 1, 2, 3, 4 and 3 N.C. auxiliary contacts max. on positions 1 ±30°, 5.  
 (2) Including add-on contacts: 3 N.C. auxiliary contacts max. on positions 1, 2, 3, 4 and 2 N.C. auxiliary contacts max. on positions 1 ±30°, 5.  
 (3) Including add-on contacts: 2 N.C. auxiliary contacts max. on positions 1, 1 ±30°, 2, 3, 4, 5.  
 (4) Use WA4 for AF09...AF65 and WA4-96 for AF80.  
 Accept 1-pole CA4 auxiliary contacts (1 block on each side of the mechanical latch) in respect to the total number of built-in or additional N.C. auxiliary contacts.  
 For WA4 accessory use with contactors coil 30, please consult your ABB local sales organization.  
 (5) VEM4 not suitable for AF..Z contactors with DC control voltages 12...20 V DC (coil 20) and 24 V DC (coil 30). Use VM4 side-mounted mechanical interlock unit.



# AF116 ... AF140 4-pole contactors

160 to 200 A AC-1  
AC / DC operated

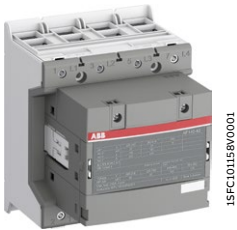

AF140-40-00

1SFCL0158V0001

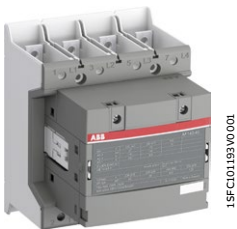

AF140-40-00B

1SFCL01193V0001

AF116 ... AF140 4-pole contactors are mainly used for controlling non-inductive or slightly inductive loads (i.e. resistance furnaces...) and generally for controlling power circuits up to 690 V AC and 350 V DC. These contactors are of the block type design with 4 main poles.

- control circuit: AC or DC operated with electronic coil interface accepting a wide control voltage range (e.g. 100...250 V AC and DC), only 4 coils to cover control voltages between 24...500 V 50/60 Hz and 20...500 V DC
  - can manage large control voltage variations
  - reduced panel energy consumption
  - very distinct closing and opening
  - can withstand short voltage dips and voltage sags (SEMI F47 conditions of use on request).
- built-in surge suppression
- add-on auxiliary contact blocks for side mounting and a wide range of accessories.

IEC	UL / CSA	Rated control circuit voltage Uc min. ... Uc max.		Auxiliary contacts fitted	Type (1)	Order code	Weight
Rated operational current $\theta \leq 40^\circ\text{C}$ AC-1	General use rating 600 V AC						Pkg (1 pce) kg
A	A	V 50/60 Hz	V DC				

### 4 N.O. main poles

#### For connection with built-in cable clamps

Rated current	UL / CSA	Uc min.	Uc max.	0	1	Type	Order code	Weight
160	160	24...60	20...60	0	0	AF116-40-00-11	1SFL427101R1100	2.250
		48...130	48...130	0	0	AF116-40-00-12	1SFL427101R1200	2.250
		100...250	100...250	0	0	AF116-40-00-13	1SFL427101R1300	2.250
		250...500	250...500	0	0	AF116-40-00-14	1SFL427101R1400	2.250
200	175	24...60	20...60	0	0	AF140-40-00-11	1SFL447101R1100	2.250
		48...130	48...130	0	0	AF140-40-00-12	1SFL447101R1200	2.250
		100...250	100...250	0	0	AF140-40-00-13	1SFL447101R1300	2.250
		250...500	250...500	0	0	AF140-40-00-14	1SFL447101R1400	2.250

#### With bar connections

Rated current	UL / CSA	Uc min.	Uc max.	0	1	Type	Order code	Weight
160	160	24...60	20...60	0	0	AF116-40-00B-11	1SFL427102R1100	2.150
		48...130	48...130	0	0	AF116-40-00B-12	1SFL427102R1200	2.150
		100...250	100...250	0	0	AF116-40-00B-13	1SFL427102R1300	2.150
		250...500	250...500	0	0	AF116-40-00B-14	1SFL427102R1400	2.150
200	175	24...60	20...60	0	0	AF140-40-00B-11	1SFL447102R1100	2.150
		48...130	48...130	0	0	AF140-40-00B-12	1SFL447102R1200	2.150
		100...250	100...250	0	0	AF140-40-00B-13	1SFL447102R1300	2.150
		250...500	250...500	0	0	AF140-40-00B-14	1SFL447102R1400	2.150

(1) For other auxiliary contacts arrangements, please contact your ABB local organization.

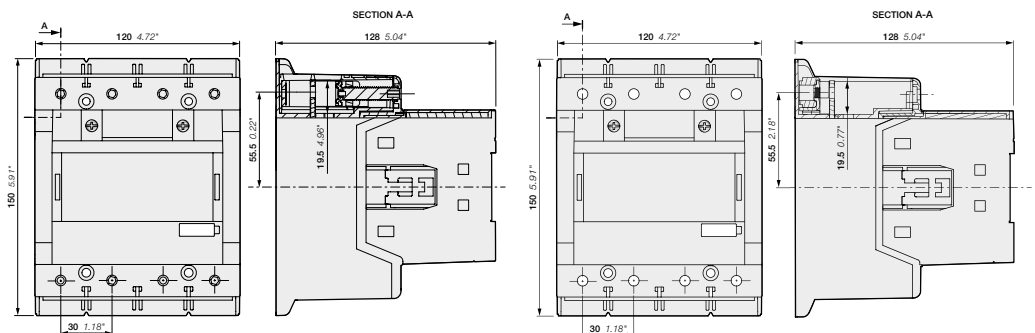

AF116, AF140-40-00

AF116, AF140-40-00B

Main dimensions mm, inches

# AF190 ... AF370 4-pole contactors

275 to 525 A AC-1  
AC / DC operated

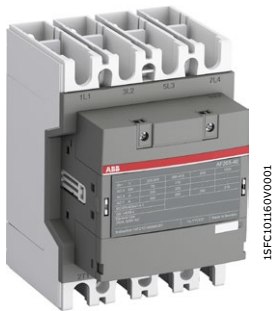

AF205-40-00

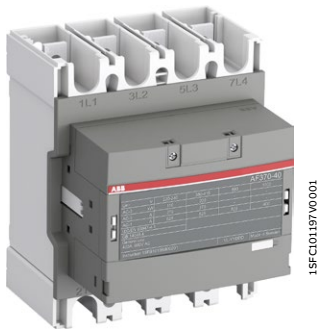

AF370-40-00

AF190 ... AF370 4-pole contactors are mainly used for controlling non-inductive or slightly inductive loads (i.e. resistance furnaces...) and generally for controlling power circuits up to 1000 V AC and 440 V DC. These contactors are of the block type design with 4 main poles.

- control circuit: AC or DC operated with electronic coil interface accepting a wide control voltage range (e.g. 100...250 V AC and DC), only 4 coils to cover control voltages between 24...500 V 50/60 Hz and 20...500 V DC
  - can manage large control voltage variations
  - reduced panel energy consumption
  - very distinct closing and opening
  - can withstand short voltage dips and voltage sags (SEMI F47 conditions of use on request).
- built-in surge suppression
- add-on auxiliary contact blocks for side mounting and a wide range of accessories.

IEC	UL / CSA	Rated control circuit voltage Uc min. ... Uc max.		Auxiliary contacts fitted	Type (1)	Order code	Weight
Rated operational current $\theta \leq 40^\circ\text{C}$ AC-1	General use rating 600 V AC						Pkg (1 pce) kg
A	A	V 50/60 Hz	V DC				

### 4 N.O. main poles

Rated current (A)	UL/CSA (A)	Uc min. (V)	Uc max. (V)	Uc min. (V DC)	Uc max. (V DC)	Type (1)	Order code	Weight (kg)
275	230	24...60	20...60	0	0	AF190-40-00-11	1SFL487102R1100	3.900
		48...130	48...130	0	0	AF190-40-00-12	1SFL487102R1200	3.900
		100...250	100...250	0	0	AF190-40-00-13	1SFL487102R1300	3.900
		250...500	250...500	0	0	AF190-40-00-14	1SFL487102R1400	3.900
350	250	24...60	20...60	0	0	AF205-40-00-11	1SFL527102R1100	3.900
		48...130	48...130	0	0	AF205-40-00-12	1SFL527102R1200	3.900
		100...250	100...250	0	0	AF205-40-00-13	1SFL527102R1300	3.900
		250...500	250...500	0	0	AF205-40-00-14	1SFL527102R1400	3.900
400	300	24...60	20...60	0	0	AF265-40-00-11	1SFL547102R1100	6.360
		48...130	48...130	0	0	AF265-40-00-12	1SFL547102R1200	6.360
		100...250	100...250	0	0	AF265-40-00-13	1SFL547102R1300	6.360
		250...500	250...500	0	0	AF265-40-00-14	1SFL547102R1400	6.360
500	350	24...60	20...60	0	0	AF305-40-00-11	1SFL587102R1100	6.360
		48...130	48...130	0	0	AF305-40-00-12	1SFL587102R1200	6.360
		100...250	100...250	0	0	AF305-40-00-13	1SFL587102R1300	6.360
		250...500	250...500	0	0	AF305-40-00-14	1SFL587102R1400	6.360
525	420	24...60	20...60	0	0	AF370-40-00-11	1SFL607102R1100	6.360
		48...130	48...130	0	0	AF370-40-00-12	1SFL607102R1200	6.360
		100...250	100...250	0	0	AF370-40-00-13	1SFL607102R1300	6.360
		250...500	250...500	0	0	AF370-40-00-14	1SFL607102R1400	6.360

(1) For other auxiliary contacts arrangements, please contact your ABB local organization.

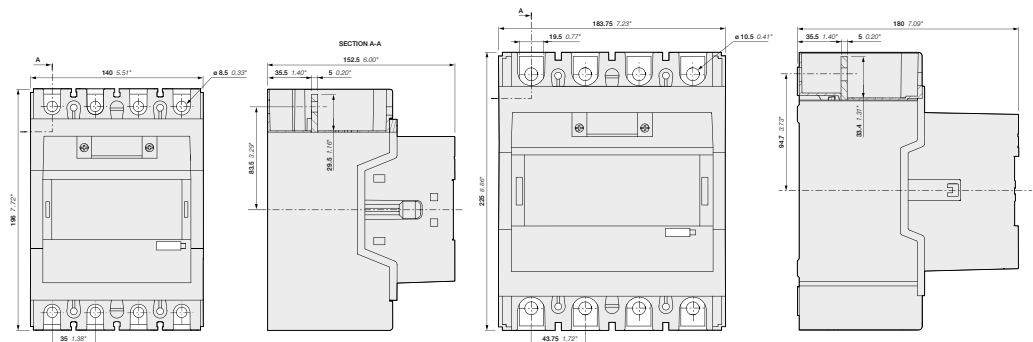

AF190, AF205

AF265, AF305, AF370

Main dimensions mm, inches

# AF116 ... AF370 4-pole contactors

## Contactors and main accessories

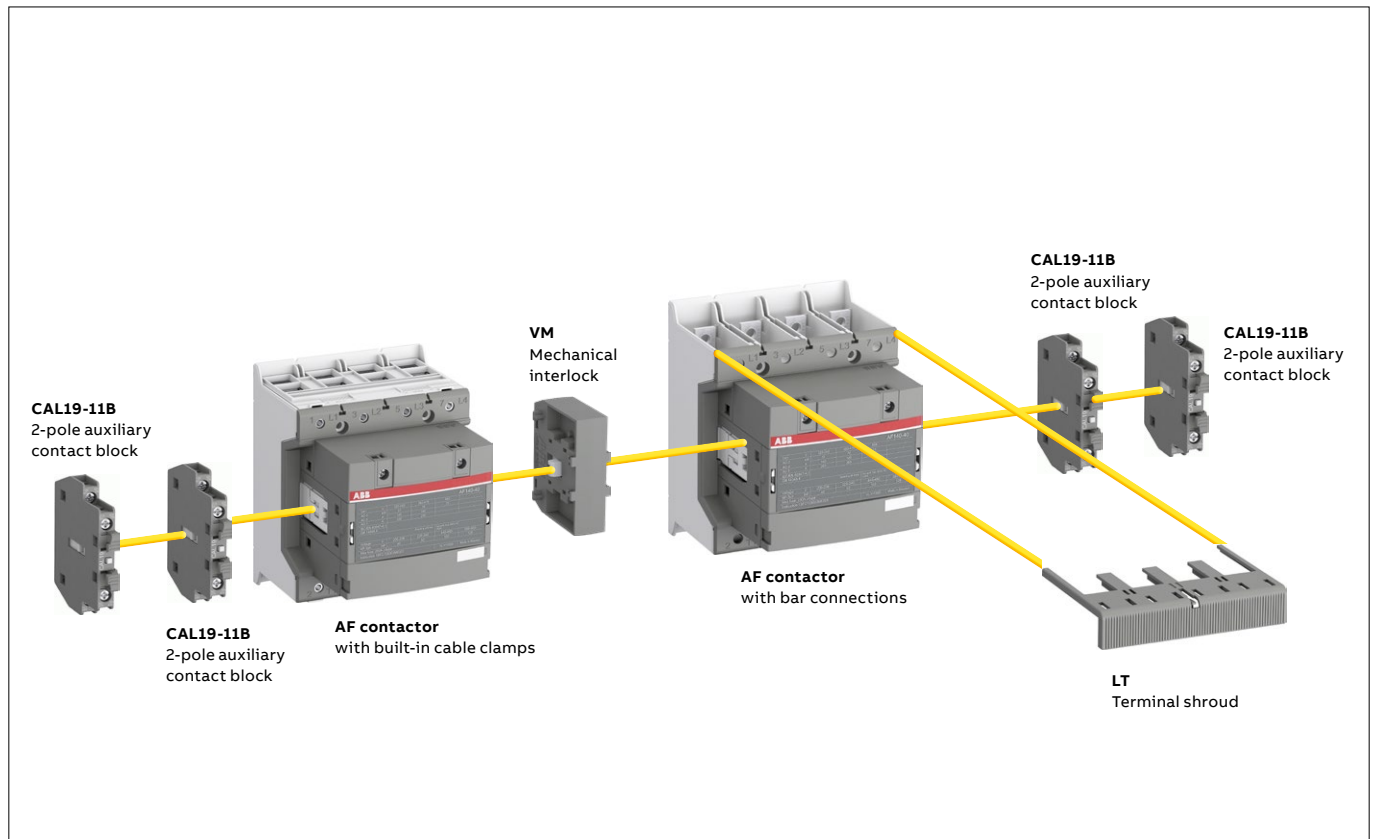

### Main accessory fitting details - for ordering details, technical data and other accessories: see section accessories

Contactor types	Main poles	Available auxiliary contacts	Side-mounted accessories		
			Auxiliary contact blocks		Mechanical interlock units (between two contactors)
			<b>CAL19-11 (3)</b>	<b>CAL19-11B (3)</b>	
AF116 ... AF370	4 0	0 0	2 x CAL19-11	+ 2 x CAL19-11B	-
AF116 ... AF370	4 0	0 0	2 x CAL19-11 (1)	+ 2 x CAL19-11B (1)	+ VM... (2)

(1) Total number of auxiliary contact blocks for the two contactors.

(2) Interlock type, according to the contactor ratings (see "Accessories").

(3) The CEL19 auxiliary contact blocks can replace the CAL19-11 and CAL19-11B. Though, no auxiliary contact block can be mounted outside the CEL19.

# AF116 ... AF140 4-pole contactors

160 to 200 A AC-1

AC / DC operated with 1 N.O. + 1 N.C. auxiliary contacts

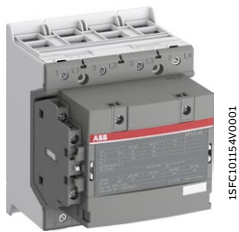

AF140-40-11

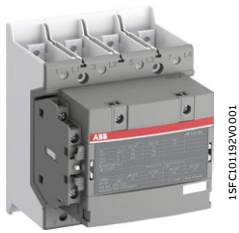

AF140-40-11B

AF116 ... AF140 4-pole contactors are mainly used for controlling non-inductive or slightly inductive loads (i.e. resistance furnaces...) and generally for controlling power circuits up to 690 V AC and 350 V DC. These contactors are of the block type design with 4 main poles.

- control circuit: AC or DC operated with electronic coil interface accepting a wide control voltage range (e.g. 100...250 V AC and DC), only 4 coils to cover control voltages between 24...500 V 50/60 Hz and 20...500 V DC
  - can manage large control voltage variations
  - reduced panel energy consumption
  - very distinct closing and opening
  - can withstand short voltage dips and voltage sags (SEMI F47 conditions of use on request).
- built-in surge suppression
- add-on auxiliary contact blocks for side mounting and a wide range of accessories.

IEC	UL / CSA	Rated control circuit voltage Uc min. ... Uc max.		Auxiliary contacts fitted	Type (1)	Order code	Weight
Rated operational current $\theta \leq 40^\circ\text{C}$ AC-1	General use rating  600 V AC						Pkg (1 pce)  kg
A	A	V 50/60 Hz	V DC				

### 4 N.O. main poles

#### For connection with built-in cable clamps

Rated current	UL / CSA	Uc min.	Uc max.	N.O.	N.C.	Type	Order code	Weight
160	160	24...60	20...60	1	1	AF116-40-11-11	1SFL427101R1111	2.270
		48...130	48...130	1	1	AF116-40-11-12	1SFL427101R1211	2.270
		100...250	100...250	1	1	AF116-40-11-13	1SFL427101R1311	2.270
		250...500	250...500	1	1	AF116-40-11-14	1SFL427101R1411	2.270
200	175	24...60	20...60	1	1	AF140-40-11-11	1SFL447101R1111	2.270
		48...130	48...130	1	1	AF140-40-11-12	1SFL447101R1211	2.270
		100...250	100...250	1	1	AF140-40-11-13	1SFL447101R1311	2.270
		250...500	250...500	1	1	AF140-40-11-14	1SFL447101R1411	2.270

#### With bar connections

Rated current	UL / CSA	Uc min.	Uc max.	N.O.	N.C.	Type	Order code	Weight
160	160	24...60	20...60	1	1	AF116-40-11B-11	1SFL427102R1111	2.170
		48...130	48...130	1	1	AF116-40-11B-12	1SFL427102R1211	2.170
		100...250	100...250	1	1	AF116-40-11B-13	1SFL427102R1311	2.170
		250...500	250...500	1	1	AF116-40-11B-14	1SFL427102R1411	2.170
200	175	24...60	20...60	1	1	AF140-40-11B-11	1SFL447102R1111	2.170
		48...130	48...130	1	1	AF140-40-11B-12	1SFL447102R1211	2.170
		100...250	100...250	1	1	AF140-40-11B-13	1SFL447102R1311	2.170
		250...500	250...500	1	1	AF140-40-11B-14	1SFL447102R1411	2.170

(1) For other auxiliary contacts arrangements, please contact your ABB local organization.

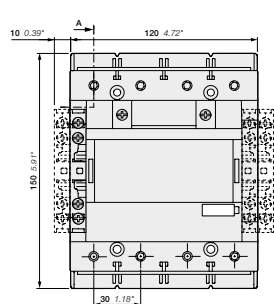

AF116, AF140-40-11

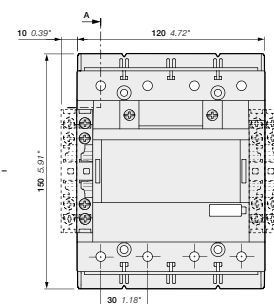
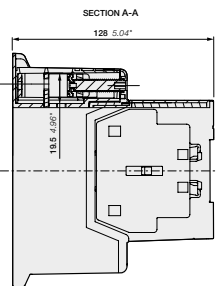

AF116, AF140-40-11B

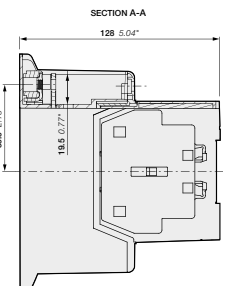

Main dimensions mm, inches

# AF190 ... AF370 4-pole contactors

275 to 525 A AC-1

AC / DC operated with 1 N.O. + 1 N.C. auxiliary contacts

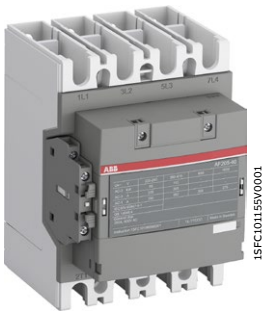

AF205-40-11

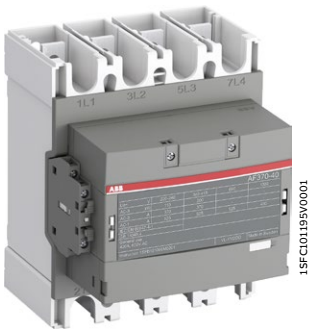

AF370-40-11

AF190 ... AF370 4-pole contactors are mainly used for controlling non-inductive or slightly inductive loads (i.e. resistance furnaces...) and generally for controlling power circuits up to 1000 V AC and 440 V DC. These contactors are of the block type design with 4 main poles.

- control circuit: AC or DC operated with electronic coil interface accepting a wide control voltage range (e.g. 100...250 V AC and DC), only 4 coils to cover control voltages between 24...500 V 50/60 Hz and 20...500 V DC
  - can manage large control voltage variations
  - reduced panel energy consumption
  - very distinct closing and opening
  - can withstand short voltage dips and voltage sags (SEMI F47 conditions of use on request).
- built-in surge suppression
- add-on auxiliary contact blocks for side mounting and a wide range of accessories.

IEC	UL / CSA	Rated control circuit voltage Uc min. ... Uc max.		Auxiliary contacts fitted	Type (1)	Order code	Weight
Rated operational current $\theta \leq 40^\circ\text{C}$ AC-1	General use rating 600 V AC						Pkg (1 pce) kg
A	A	V 50/60 Hz	V DC				

### 4 N.O. main poles

Rated operational current	UL / CSA rating	Uc min.	Uc max.	Uc min.	Uc max.	Type (1)	Order code	Weight
275	230	24...60	20...60	1	1	AF190-40-11-11	1SFL487102R1111	3.920
		48...130	48...130	1	1	AF190-40-11-12	1SFL487102R1211	3.920
		100...250	100...250	1	1	AF190-40-11-13	1SFL487102R1311	3.920
350	250	250...500	250...500	1	1	AF190-40-11-14	1SFL487102R1411	3.920
		24...60	20...60	1	1	AF205-40-11-11	1SFL527102R1111	3.920
		48...130	48...130	1	1	AF205-40-11-12	1SFL527102R1211	3.920
400	300	100...250	100...250	1	1	AF205-40-11-13	1SFL527102R1311	3.920
		250...500	250...500	1	1	AF205-40-11-14	1SFL527102R1411	3.920
		24...60	20...60	1	1	AF265-40-11-11	1SFL547102R1111	6.380
500	350	48...130	48...130	1	1	AF265-40-11-12	1SFL547102R1211	6.380
		100...250	100...250	1	1	AF265-40-11-13	1SFL547102R1311	6.380
		250...500	250...500	1	1	AF265-40-11-14	1SFL547102R1411	6.380
525	420	24...60	20...60	1	1	AF305-40-11-11	1SFL587102R1111	6.380
		48...130	48...130	1	1	AF305-40-11-12	1SFL587102R1211	6.380
		100...250	100...250	1	1	AF305-40-11-13	1SFL587102R1311	6.380
		250...500	250...500	1	1	AF305-40-11-14	1SFL587102R1411	6.380
525	420	24...60	20...60	1	1	AF370-40-11-11	1SFL607102R1111	6.380
		48...130	48...130	1	1	AF370-40-11-12	1SFL607102R1211	6.380
		100...250	100...250	1	1	AF370-40-11-13	1SFL607102R1311	6.380
250...500	250...500	1	1	AF370-40-11-14	1SFL607102R1411	6.380		

(1) For other auxiliary contacts arrangements, please contact your ABB local organization.

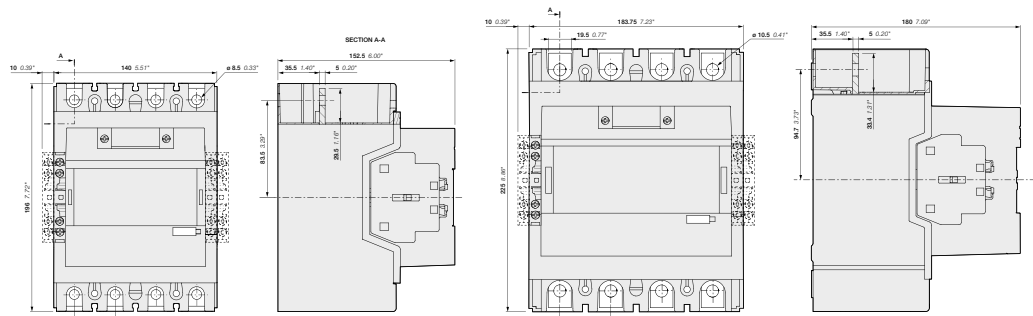

AF190, AF205

AF265, AF305, AF370

Main dimensions mm, inches

# AF116 ... AF370 4-pole contactors with 1 N.O. + 1 N.C. auxiliary contacts

## Contactors and main accessories

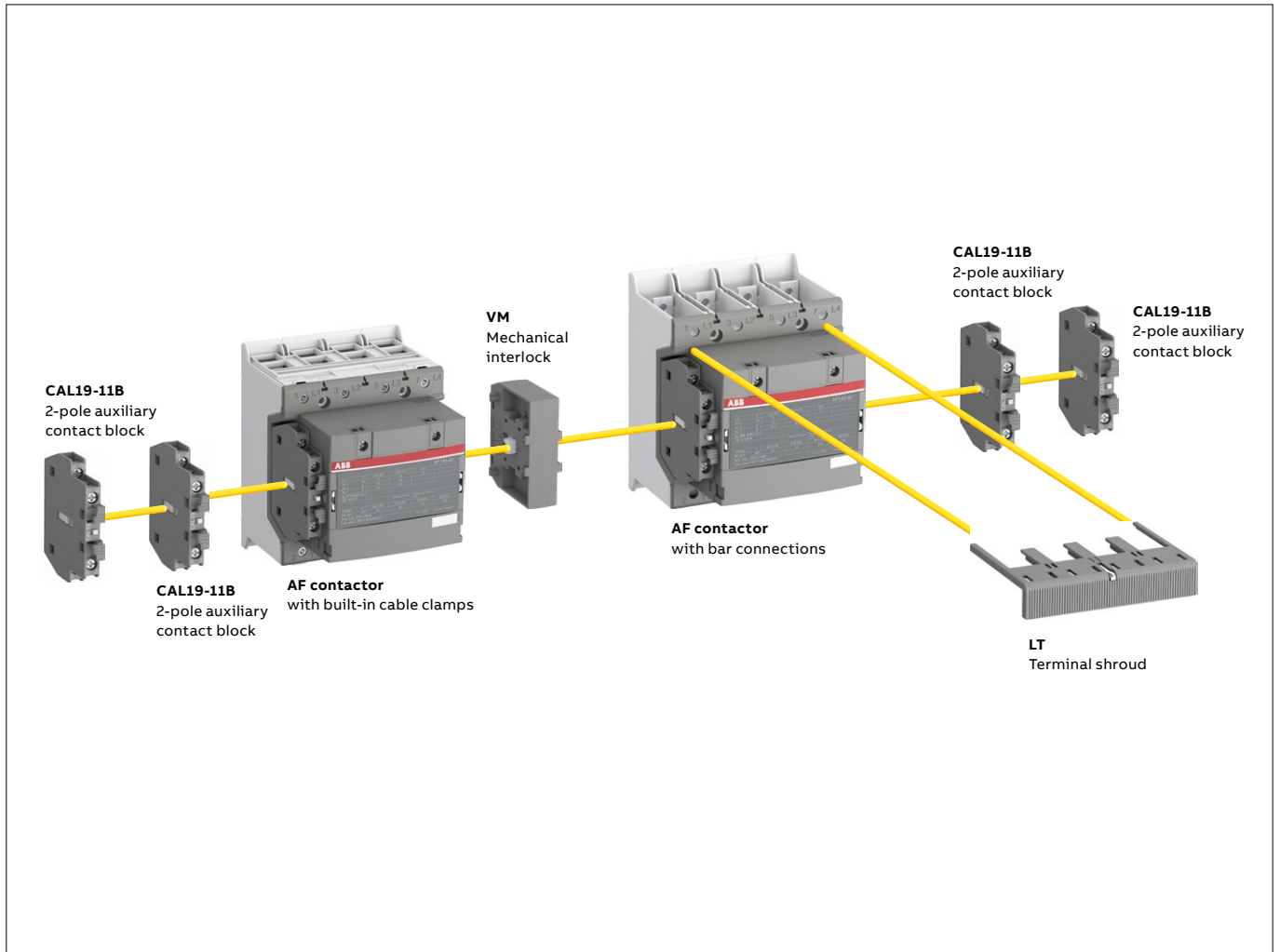

### Main accessory fitting details - for ordering details, technical data and other accessories: see section accessories

Contactor types	Main poles	Available auxiliary contacts	Side-mounted accessories		
			Auxiliary contact blocks		Mechanical interlock units (between two contactors)
			<b>CAL19-11</b>	<b>CAL19-11B</b>	
AF116 ... AF370	4 0	1 1	1 x CAL19-11	+ 2 x CAL19-11B	-
AF116 ... AF370	4 0	1 1	-	+ 2 x CAL19-11B (1)	+ VM... (2)

(1) Total number of auxiliary contact blocks for the two contactors.  
 (2) Interlock type, according to the contactor ratings (see "Accessories").

# AF116 ... AF140 4-pole contactors

160 to 200 A AC-1

AC / DC operated with 2 N.O. + 2 N.C. auxiliary contacts



AF140-40-22



AF140-40-22B

AF116 ... AF140 4-pole contactors are mainly used for controlling non-inductive or slightly inductive loads (i.e. resistance furnaces...) and generally for controlling power circuits up to 690 V AC and 350 V DC. These contactors are of the block type design with 4 main poles.

- control circuit: AC or DC operated with electronic coil interface accepting a wide control voltage range (e.g. 100...250 V AC and DC), only 4 coils to cover control voltages between 24...500 V 50/60 Hz and 20...500 V DC
  - can manage large control voltage variations
  - reduced panel energy consumption
  - very distinct closing and opening
  - can withstand short voltage dips and voltage sags (SEMI F47 conditions of use on request).
- built-in surge suppression
- add-on auxiliary contact blocks for side mounting and a wide range of accessories.

IEC	UL / CSA	Rated control circuit voltage Uc min. ... Uc max.	Auxiliary contacts fitted	Type (1)	Order code	Weight
Rated operational current $\theta \leq 40^\circ\text{C}$ AC-1	General use rating 600 V AC					Pkg (1 pce) kg
A	A	V 50/60 Hz   V DC				

### 4 N.O. main poles

#### For connection with built-in cable clamps

Rated current	UL / CSA	Uc min.	Uc max.	NO	NC	Type	Order code	Weight
160	160	24...60	20...60	2	2	AF116-40-22-11	1SFL427101R1122	2.290
		48...130	48...130	2	2	AF116-40-22-12	1SFL427101R1222	2.290
		100...250	100...250	2	2	AF116-40-22-13	1SFL427101R1322	2.290
		250...500	250...500	2	2	AF116-40-22-14	1SFL427101R1422	2.290
200	175	24...60	20...60	2	2	AF140-40-22-11	1SFL447101R1122	2.290
		48...130	48...130	2	2	AF140-40-22-12	1SFL447101R1222	2.290
		100...250	100...250	2	2	AF140-40-22-13	1SFL447101R1322	2.290
		250...500	250...500	2	2	AF140-40-22-14	1SFL447101R1422	2.290

#### With bar connections

Rated current	UL / CSA	Uc min.	Uc max.	NO	NC	Type	Order code	Weight
160	160	24...60	20...60	2	2	AF116-40-22B-11	1SFL427102R1122	2.190
		48...130	48...130	2	2	AF116-40-22B-12	1SFL427102R1222	2.190
		100...250	100...250	2	2	AF116-40-22B-13	1SFL427102R1322	2.190
		250...500	250...500	2	2	AF116-40-22B-14	1SFL427102R1422	2.190
200	175	24...60	20...60	2	2	AF140-40-22B-11	1SFL447102R1122	2.190
		48...130	48...130	2	2	AF140-40-22B-12	1SFL447102R1222	2.190
		100...250	100...250	2	2	AF140-40-22B-13	1SFL447102R1322	2.190
		250...500	250...500	2	2	AF140-40-22B-14	1SFL447102R1422	2.190

(1) For other auxiliary contacts arrangements, please contact your ABB local organization.

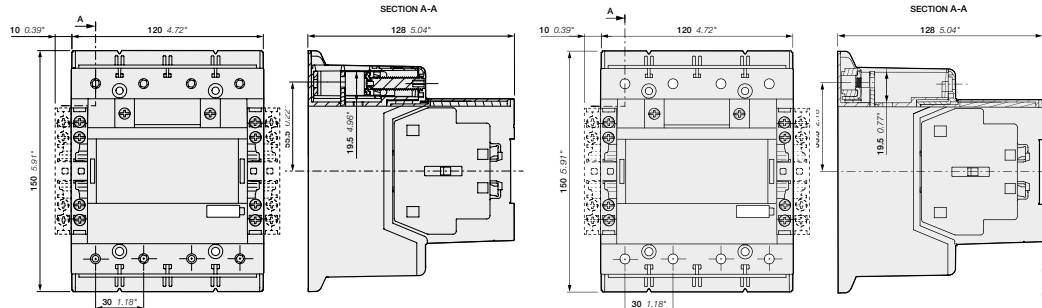

AF116, AF140-40-11

AF116, AF140-40-11B

Main dimensions mm, inches



# AF190 ... AF370 4-pole contactors

275 to 525 A AC-1

AC / DC operated with 2 N.O. + 2 N.C. auxiliary contacts

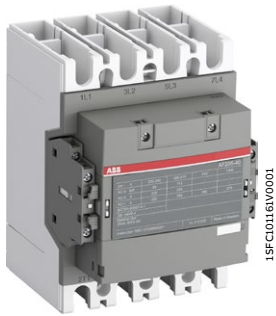

AF205-40-22

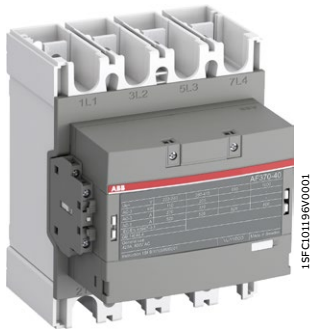

AF370-40-22

AF190 ... AF370 4-pole contactors are mainly used for controlling non-inductive or slightly inductive loads (i.e. resistance furnaces...) and generally for controlling power circuits up to 1000 V AC and 440 V DC. These contactors are of the block type design with 4 main poles.

- control circuit: AC or DC operated with electronic coil interface accepting a wide control voltage range (e.g. 100...250 V AC and DC), only 4 coils to cover control voltages between 24...500 V 50/60 Hz and 20...500 V DC
  - can manage large control voltage variations
  - reduced panel energy consumption
  - very distinct closing and opening
  - can withstand short voltage dips and voltage sags (SEMI F47 conditions of use on request).
- built-in surge suppression
- add-on auxiliary contact blocks for side mounting and a wide range of accessories.

IEC	UL / CSA	Rated control circuit voltage Uc min. ... Uc max.		Auxiliary contacts fitted	Type (1)	Order code	Weight
Rated operational current $\theta \leq 40^\circ\text{C}$ AC-1	General use rating 600 V AC						Pkg (1 pce) kg
A	A	V 50/60 Hz	V DC				

### 4 N.O. main poles

Rated operational current (A)	UL / CSA rating (A)	Uc min. (V)	Uc max. (V)	Coils	Type	Order code	Weight (kg)
275	230	24...60	20...60	2 2	AF190-40-22-11	1SFL487102R1122	3.940
		48...130	48...130	2 2	AF190-40-22-12	1SFL487102R1222	3.940
		100...250	100...250	2 2	AF190-40-22-13	1SFL487102R1322	3.940
		250...500	250...500	2 2	AF190-40-22-14	1SFL487102R1422	3.940
350	250	24...60	20...60	2 2	AF205-40-22-11	1SFL527102R1122	3.940
		48...130	48...130	2 2	AF205-40-22-12	1SFL527102R1222	3.940
		100...250	100...250	2 2	AF205-40-22-13	1SFL527102R1322	3.940
		250...500	250...500	2 2	AF205-40-22-14	1SFL527102R1422	3.940
400	300	24...60	20...60	2 2	AF265-40-22-11	1SFL547102R1122	6.400
		48...130	48...130	2 2	AF265-40-22-12	1SFL547102R1222	6.400
		100...250	100...250	2 2	AF265-40-22-13	1SFL547102R1322	6.400
		250...500	250...500	2 2	AF265-40-22-14	1SFL547102R1422	6.400
500	350	24...60	20...60	2 2	AF305-40-22-11	1SFL587102R1122	6.400
		48...130	48...130	2 2	AF305-40-22-12	1SFL587102R1222	6.400
		100...250	100...250	2 2	AF305-40-22-13	1SFL587102R1322	6.400
		250...500	250...500	2 2	AF305-40-22-14	1SFL587102R1422	6.400
525	420	24...60	20...60	2 2	AF370-40-22-11	1SFL607102R1122	6.400
		48...130	48...130	2 2	AF370-40-22-12	1SFL607102R1222	6.400
		100...250	100...250	2 2	AF370-40-22-13	1SFL607102R1322	6.400
		250...500	250...500	2 2	AF370-40-22-14	1SFL607102R1422	6.400

(1) For other auxiliary contacts arrangements, please contact your ABB local organization.

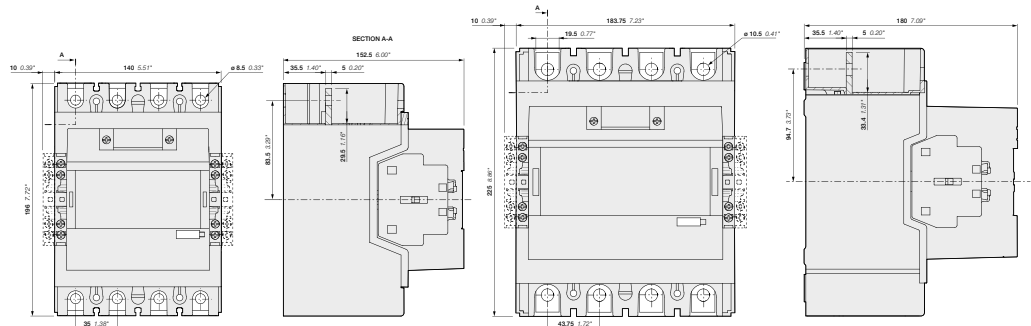

AF190, AF205

AF265, AF305, AF370

Main dimensions mm, inches



## AF116 ... AF370 4-pole contactors with 2 N.O. + 2 N.C. auxiliary contacts

Contactors and main accessories

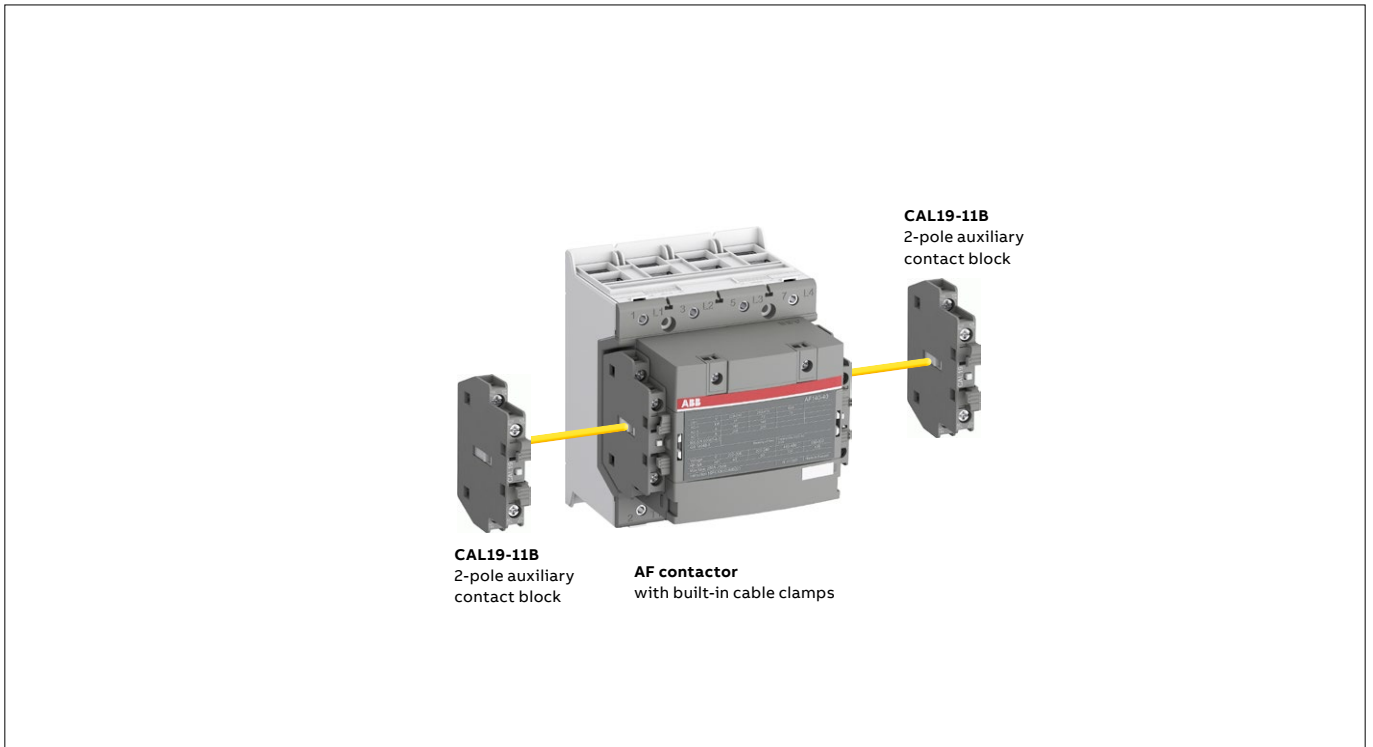

### Main accessory fitting details - for ordering details, technical data and other accessories: see section accessories

Contactor types	Main poles	Available auxiliary contacts	Side-mounted accessories		
			Auxiliary contact blocks		Mechanical interlock units (between two contactors)
			<b>CAL19-11 (1)</b>	<b>CAL19-11B (1)</b>	
AF116 ... AF370	4 0	2 2	2 x CAL19-11 included	+ 2 x CAL19-11B	-

(1) The CEL19 auxiliary contact blocks can replace the CAL19-11 and CAL19-11B. Though, no auxiliary contact block can be mounted outside the CEL19.

# EK550, EK1000 4-pole contactors

800 to 1000 A AC-1

AC operated with 1 N.O. + 1 N.C. auxiliary contacts



EK1000-40-11

1SFC099-069

EK550 4-pole contactors are mainly used for controlling non-inductive or slightly inductive loads (i.e. resistance furnaces...) and generally for controlling power circuits up to 1000 V AC and 600 V DC, EK1000 up to 1000 V AC.

These contactors are of the block type design with:

- 4 main poles
- control circuit: AC operated
- add-on auxiliary contact blocks for side mounting and a wide range of accessories.

IEC Rated operational current $\theta \leq 40^\circ\text{C}$ AC-1 A	UL/CSA General use rating 600 V AC A	Rated control circuit voltage $U_c$ (1)		Auxiliary contacts fitted 	Type	Order code	Weight  Pkg (1 pce)  kg
		V 50 Hz	V 60 Hz				
800	540	220	220...240	1 1	EK550-40-11	SK827041-EL	17.200
		220...230	230...255	1 1	EK550-40-11	SK827041-EM	17.200
		400...415	-	1 1	EK550-40-11	SK827041-AR	17.200
1000	-	220	220...240	1 1	EK1000-40-11	SK827044-EL	17.500
		220...230	230...255	1 1	EK1000-40-11	SK827044-EM	17.500
		400...415	-	1 1	EK1000-40-11	SK827044-AR	17.500

(1) Other control voltages see voltage code table.

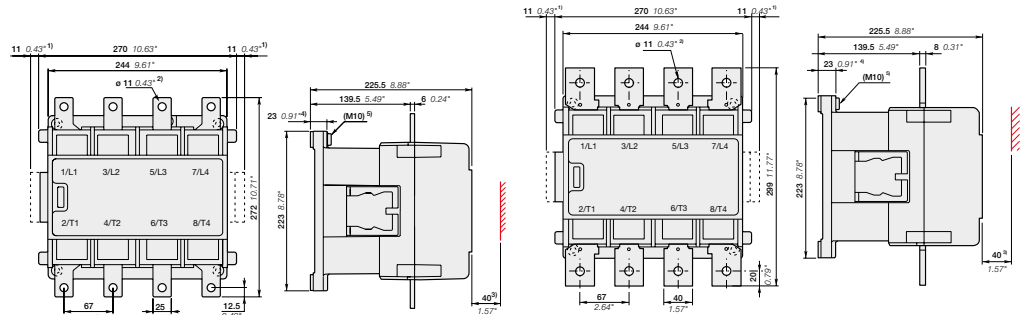

- EK550**
- 1) Dimension for extra auxiliary contact block.
  - 2) Screw, nut and washer by-packed.
  - 3) Min. distance to uninsulated wall.
  - 4) Damping elements are included.
  - 5) Earthing screw.

**EK1000**

Main dimensions mm, inches

# EK550, EK1000 4-pole contactors

800 to 1000 A AC-1

DC operated with 2 N.O. + 1 N.C. auxiliary contacts



EK1000-40-21

EK550 4-pole contactors are mainly used for controlling non-inductive or slightly inductive loads (i.e. resistance furnaces...) and generally for controlling power circuits up to 1000 V AC and 600 V DC, EK1000 up to 1000 V AC.

These contactors are of the block type design with:

- 4 main poles
- control circuit: DC operated
- add-on auxiliary contact blocks for side mounting and a wide range of accessories.

IEC	UL / CSA	Rated control circuit voltage Uc	Auxiliary contacts fitted	Type	Order code	Weight
Rated operational current $\theta \leq 40^\circ\text{C}$ AC-1	General use rating 600 V AC					Pkg (1 pce) kg
A	A	V DC				
800	540	48	2 1	EK550-40-21	SK827041-DD	17.200
		110	2 1	EK550-40-21	SK827041-DE	17.200
		125	2 1	EK550-40-21	SK827041-DU	17.200
		220	2 1	EK550-40-21	SK827041-DF	17.200
1000	-	36	2 1	EK1000-40-21	SK827044-DC	17.500
		48	2 1	EK1000-40-21	SK827044-DD	17.500
		60	2 1	EK1000-40-21	SK827044-DT	17.500
		110	2 1	EK1000-40-21	SK827044-DE	17.500
		125	2 1	EK1000-40-21	SK827044-DU	17.500
		220	2 1	EK1000-40-21	SK827044-DF	17.500

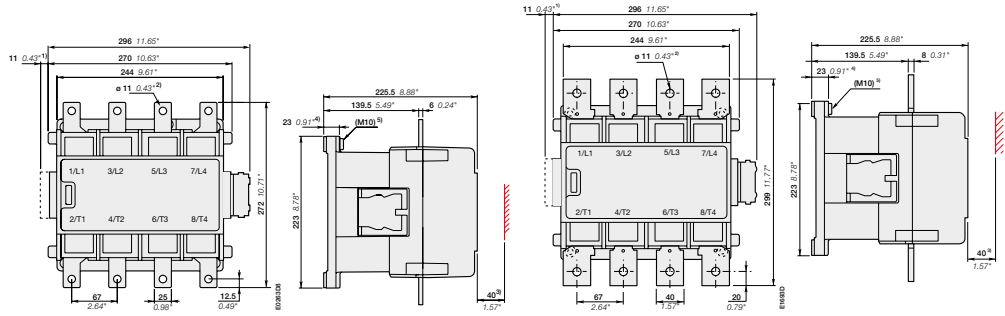

- EK550**
- 1) Dimension for extra auxiliary contact block.
  - 2) Screw, nut and washer by-packed.
  - 3) Min. distance to uninsulated wall.
  - 4) Damping elements are included.
  - 5) Earthing screw.

EK1000

# EK550, EK1000 4-pole Contactors

800 to 1000 A AC-1

AC operated with 2 N.O. + 2 N.C. auxiliary contacts



EK1000-40-22

EK550 4-pole contactors are mainly used for controlling non-inductive or slightly inductive loads (i.e. resistance furnaces...) and for controlling power circuits up to 1000 V AC and 600 V DC, EK1000 up to 1000 V AC.

These contactors are of the block type design with:

- 4 main poles
- control circuit: AC operated
- add-on auxiliary contact blocks for side mounting and a wide range of accessories

IEC Rated operational current $\theta \leq 40^\circ\text{C}$ AC-1	UL/CSA General use rating 600 V AC A	Rated control circuit voltage Uc (1)		Auxiliary contacts fitted 	Type	Order code	Weight  Pkg (1 pce)  kg
		V 50 Hz	V 60 Hz				
800	540	220	220...240	2 2	EK550-40-22	SK827043-EL	17.200
		220...230	230...255	2 2	EK550-40-22	SK827043-EM	17.200
		400...415	-	2 2	EK550-40-22	SK827043-AR	17.200
1000	-	220	220...240	2 2	EK1000-40-22	SK827045-EL	17.500
		220...230	230...255	2 2	EK1000-40-22	SK827045-EM	17.500
		380	380...415	2 2	EK1000-40-22	SK827045-EP	17.500
		380...400	400...440	2 2	EK1000-40-22	SK827045-ER	17.500
		400...415	-	2 2	EK1000-40-22	SK827045-AR	17.500

(1) Other control voltages see voltage code table.

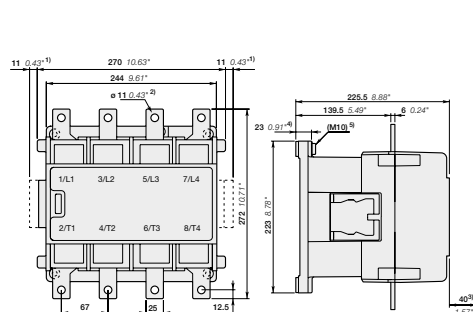

EK550

- 1) Dimension for extra auxiliary contact block
- 2) Screw, nut and washer by-packed
- 3) Min. distance to uninsulated wall
- 4) Damping elements are included
- 5) Earthing screw

Main dimensions mm, inches

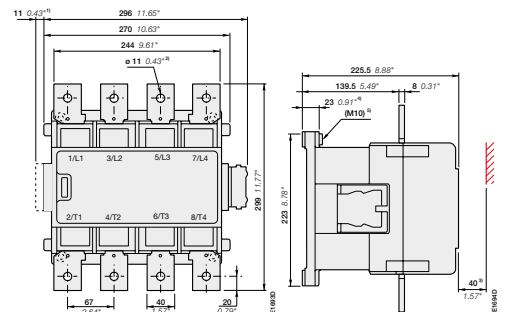

EK1000

# EK550, EK1000 4-pole contactors with 1 N.O. + 1 N.C. and 2 N.O. + 1 N.C. auxiliary contacts

Main accessory fitting details - for ordering details, technical data and other accessories: see section accessories

Mounting positions of the auxiliary contact	Auxiliary contact types and connecting diagrams
	<p>(1) Contact 35-36 used for some types of EK... contactors</p>

## EK 4-pole contactors

Contactor types	Main poles	Available auxiliary contacts	Add-on auxiliary contact blocks	Mounting and positioning
			2-pole CAL16-11 ...	 

### AC operated, 50 Hz, 60 Hz or 50/60 Hz

EK550, EK1000	4 0	1 1	 + 1 x CAL16-11B + 1 x CAL16-11C + 1 x CAL16-11D	
---------------	-----	-----	---	--

### DC operated

EK550, EK1000	4 0	2 1	 + 1 x CAL16-11C	
---------------	-----	-----	---------------------	--

## EK 4-pole reversing contactors with VH800 mechanical and electrical interlock units

"Left hand" contactors	Interlocking	"Right hand" contactors	Add-on auxiliary contact blocks	Mounting and positioning
			2-pole CAL16-11 ...	 

### AC operated, 50 Hz, 60 Hz or 50/60 Hz

EK550, EK1000	VH800	EK550, EK1000	+ 1 x CAL16-11C + 1 x CAL16-11D	
---------------	-------	---------------	------------------------------------	--

### DC operated

EK550, EK1000	VH800	EK550, EK1000	-	
---------------	-------	---------------	---	--

## EK550, EK1000 4-pole contactors with 1 N.O. + 1 N.C. auxiliary contacts and 2 N.O. + 1 N.C. auxiliary contacts

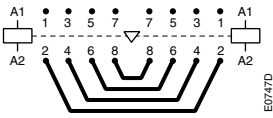

BSS550 ... BSS1000



RC-EH

For contactors	Auxiliary contacts	Type	Order code	Pkg qty	Weight (1 pce)
					kg

### Side-mounted auxiliary contact blocks

EK	1	1	Order code	Pkg qty	Weight (1 pce)
	1	1	CAL16-11B	1	0.050
	1	1	CAL16-11C	1	0.050
	1	1	CAL16-11D	1	0.050
	1	1	CCL16-11E (2)	1	0.050

### Mechanical interlock unit for two horizontal mounted contactors

EK550, EK1000	VH800	Order code	Pkg qty	Weight (1 pce)
		SK829070-F	1	6.000

### Connecting sets

EK550	BSS550	Order code	Pkg qty	Weight (1 pce)
		SK829090-E	1	3.300
EK1000	BSS1000	Order code	Pkg qty	Weight (1 pce)
		SK829090-H	1	5.500

### Surge suppressors

For contactors	Rated control circuit voltage U <sub>c</sub>		Type	Order code	Pkg qty	Weight (1 pce)
	V	AC DC				
EK550, EK1000	48...110	● -	RC-EH800/110	SK829007-C	1	0.015
EK550, EK1000	24...125	- ●	RC-EH800/110	SK829007-C	1	0.015
EK550, EK1000	220...600	● -	RC-EH800/600	SK829007-D	1	0.015



See "Main accessory fitting details" table.

(2) Mounting of CCL16-11E blocks does not allow an additional second block to be added on top of it.  
All DC operated EK contactors are equipped with one CCL16-11E on the right side.

# AF09 ... AF80 4-pole contactors

## Technical data

### Main pole - Utilization characteristics according to IEC

Contactor types	AC / DC operated	AF09	AF16	AF26	AF38	AF40	AF52	AF80	
Standards		IEC 60947-1 / 60947-4-1 and EN 60947-1 / 60947-4-1							
Rated operational voltage Ue max.		1000 V							
Rated frequency (without derating)		50 / 60 Hz							
Conventional free-air thermal current Ith acc. to IEC 60947-4-1, open contactors, $\theta \leq 40^\circ\text{C}$		35 A	35 A	55 A	55 A	105 A	105 A	125 A	
With conductor cross-sectional area		6 mm <sup>2</sup>	6 mm <sup>2</sup>	16 mm <sup>2</sup>	16 mm <sup>2</sup>	35 mm <sup>2</sup>	35 mm <sup>2</sup>	50 mm <sup>2</sup>	
AC-1 Utilization category									
For air temperature close to contactor									
le / Rated operational current AC-1	$\theta \leq 40^\circ\text{C}$	25 A	30 A	45 A	55 A	70 A	100 A	125 A	
Ue max. $\leq 690\text{ V}, 50/60\text{ Hz}$	$\theta \leq 60^\circ\text{C}$	25 A	30 A	40 A	45 A	60 A	80 A	105 A	
	$\theta \leq 70^\circ\text{C}$	22 A	26 A	32 A	37 A	50 A	70 A	90 A	
With conductor cross-sectional area		4 mm <sup>2</sup>	6 mm <sup>2</sup>	10 mm <sup>2</sup>	16 mm <sup>2</sup>	35 mm <sup>2</sup>	35 mm <sup>2</sup>	50 mm <sup>2</sup>	
AC-3 Utilization category									
For air temperature close to contactor $\theta \leq 60^\circ\text{C}$									
le / Max. rated operational current AC-3 (1)									
 3-phase motors	220-230-240 V	9 A	18 A	23.2 A	23.2 A	40 A	53 A	80 A	
	380-400 V	9 A	18 A	22 A	22 A	40 A	53 A	80 A	
	415 V	9 A	18 A	21.2 A	21.2 A	40 A	53 A	80 A	
	440 V	9 A	18 A	20 A	20 A	40 A	53 A	80 A	
	500 V	9.5 A	15 A	17.6 A	17.6 A	35 A	45 A	65 A	
	690 V	7 A	10.5 A	10.5 A	10.5 A	25 A	35 A	49 A	
	1000 V							25 A	
	Rated operational power AC-3 (1)								
 1500 r.p.m. 50 Hz 1800 r.p.m. 60 Hz 3-phase motors	220-230-240 V	2.2 kW	4 kW	5.5 kW	5.5 kW	11 kW	15 kW	22 kW	
	380-400 V	4 kW	7.5 kW	11 kW (3)	11 kW (3)	18.5 kW	22 kW	37 kW	
	415 V	4 kW	9 kW	11 kW	11 kW	22 kW	30 kW	45 kW	
	440 V	4 kW	9 kW	11 kW	11 kW	22 kW	30 kW	45 kW	
	500 V	5.5 kW	9 kW	11 kW	11 kW	22 kW	30 kW	45 kW	
	690 V	5.5 kW	9 kW	9 kW	9 kW	22 kW	30 kW	45 kW	
	1000 V							35 kW	
	Rated making capacity AC-3		10 x Ie AC-3 acc. to IEC 60947-4-1						
Rated breaking capacity AC-3		8 x Ie AC-3 acc. to IEC 60947-4-1							
Short-circuit protection device for contactors									
Without thermal overload relay - Motor protection excluded									
Ue $\leq 500\text{ V AC}$ - gG type fuse		25 A	32 A	50 A	63 A	80 A	110 A	160 A	
Rated short-time withstand current Icw	1 s	300 A	300 A	450 A	450 A	1000 A	1000 A	1200 A	
At 40 °C ambient temperature, in free air from a cold state	10 s	150 A	150 A	300 A	300 A	600 A	600 A	780 A	
	30 s	80 A	80 A	225 A	225 A	350 A	350 A	450 A	
	1 min	60 A	60 A	150 A	150 A	250 A	250 A	300 A	
	15 min	35 A	35 A	55 A	55 A	110 A	110 A	140 A	
	Maximum breaking capacity	N.O. main pole	at 440 V	250 A	250 A	-	-	950 A	950 A
		at 690 V	106 A	106 A	-	-	600 A	600 A	750 A
	N.C. Main pole	at 440 V	-	-	-	-	600 A	-	900 A
		at 690 V	-	-	-	-	300 A	-	750 A
Power dissipation per pole	le / AC-1	0.8 W	1.2 W	1.6 W	2.3 W	3 W	6.3 W	8 W	
	le / AC-3	0.1 W	0.35 W	0.42 W	0.42 W	1 W	1.7 W	3.2 W	
Max. electrical switching frequency	AC-1	600 cycles/h							

(1) For the corresponding kW/A values of 1500 r.p.m, 50 Hz or 1800 r.p.m, 60 Hz, 3-phase motors, see "Motor Rated Operational Powers and Currents"

(2) For the protection of motor starters against short circuits, see "Coordination with Short-circuit Protection Devices".

(3) 400 V 3-phase motors only.

# AF116 ... EK1000 4-pole contactors

## Technical data

### Main pole - Utilization characteristics according to IEC

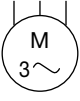
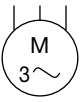
Contactor types	AC / DC operated	AF116	AF140	AF190	AF205	AF265	AF305	AF370	EK550	EK1000
Standards		IEC 60947-1 / 60947-4-1 and EN 60947-1 / 60947-4-1								
Rated operational voltage U <sub>e</sub> max.		690 V		1000 V						
Rated frequency (without derating)		50 / 60 Hz								
Conventional free-air thermal current I <sub>th</sub>										
acc. to IEC 60947-4-1, open contactors, $\theta \leq 40^\circ\text{C}$		160 A	200 A	275 A	350 A	400 A	500 A	525 A	800 A	1000 A
With conductor cross-sectional area		70 mm <sup>2</sup>	95 mm <sup>2</sup>	150 mm <sup>2</sup>	240 mm <sup>2</sup> (3)	240 mm <sup>2</sup>	300 mm <sup>2</sup> (4)	2x 185 mm <sup>2</sup> (4)	2x 240 mm <sup>2</sup>	2x 300 mm <sup>2</sup>
AC-1 Utilization category										
For air temperature close to contactor										
I <sub>e</sub> / Rated operational current AC-1	$\theta \leq 40^\circ\text{C}$	160 A	200 A	275 A	350 A	400 A	500 A	525 A	800 A	1000 A
U <sub>e</sub> max. $\leq 690\text{ V}, 50/60\text{ Hz}$	$\theta \leq 60^\circ\text{C}$	145 A	175 A	250 A	300 A	350 A	400 A	425 A	650 A	800 A
	$\theta \leq 70^\circ\text{C}$	130 A	160 A	200 A	240 A	290 A	325 A	350 A	575 A	720 A
U <sub>e</sub> max. $\leq 1000\text{ V}, 50/60\text{ Hz}$	$\theta \leq 40^\circ\text{C}$	-	-	250 A	275 A	350 A	375 A	400 A	800 A	1000 A
	$\theta \leq 60^\circ\text{C}$ (2)	-	-	225 A	250 A	300 A	325 A	350 A	650 A	800 A
	$\theta \leq 70^\circ\text{C}$	-	-	185 A	200 A	240 A	260 A	290 A	575 A	720 A
With conductor cross-sectional area		70 mm <sup>2</sup>	95 mm <sup>2</sup>	150 mm <sup>2</sup>	240 mm <sup>2</sup> (3)	240 mm <sup>2</sup>	300 mm <sup>2</sup> (4)	2x 185 mm <sup>2</sup> (4)	2x 240 mm <sup>2</sup>	2x 300 mm <sup>2</sup>
AC-3 Utilization category										
For air temperature close to contactor $\theta \leq 60^\circ\text{C}$ (2)										
I <sub>e</sub> / Max. rated operational current AC-3 (1)										
 3-phase motors	220-230-240 V	116 A	140 A	190 A	205 A	265 A	305 A	370 A	550 A	-
	380-400 V	116 A	140 A	190 A	205 A	265 A	305 A	370 A	550 A	-
	415 V	116 A	140 A	190 A	205 A	265 A	305 A	370 A	550 A	-
	440 V	116 A	140 A	190 A	205 A	265 A	305 A	370 A	550 A	-
	500 V	-	-	-	-	-	-	-	550 A	-
	690 V	-	-	-	-	-	-	-	550 A	-
	1000 V	-	-	-	-	-	-	-	175 A	-
 1500 r.p.m. 50 Hz 1800 r.p.m. 60 Hz 3-phase motors	220-230-240 V	30 kW	37 kW	55 kW	55 kW	75 kW	90 kW	110 kW	160 kW	-
	380-400 V	55 kW	75 kW	90 kW	110 kW	132 kW	160 kW	200 kW	280 kW	-
	415 V	55 kW	75 kW	90 kW	110 kW	132 kW	160 kW	200 kW	315 kW	-
	440 V	75 kW	90 kW	110 kW	132 kW	160 kW	160 kW	200 kW	315 kW	-
	500 V	-	-	-	-	-	-	-	400 kW	-
	690 V	-	-	-	-	-	-	-	500 kW	-
	1000 V	-	-	-	-	-	-	-	250 kW	-
Rated making capacity AC-3		10 x I <sub>e</sub> AC-3 acc. to IEC 60947-4-1								
Rated breaking capacity AC-3		8 x I <sub>e</sub> AC-3 acc. to IEC 60947-4-1								
Short-circuit protection device for contactors										
Without thermal overload relay - Motor protection excluded										
U <sub>e</sub> $\leq 500\text{ V AC}$ - gG type fuse		200 A	250 A	355 A	400 A	630 A	630 A	630 A	800 A	1000 A
Rated short-time withstand current I <sub>cw</sub>	1 s	1300 A	1460 A	1900 A	2050 A	2650 A	3050 A	3700 A	5500 A	6800 A
At 40 °C ambient temperature, in free air from a cold state	10 s	928 A	1168 A	1520 A	1640 A	2120 A	2440 A	2960 A	5300 A	6400 A
	30 s	536 A	674 A	878 A	947 A	1224 A	1409 A	1709 A	3700 A	4400 A
	1 min	379 A	477 A	621 A	670 A	865 A	996 A	1208 A	3000 A	3400 A
	15 min	160 A	200 A	275 A	350 A	400 A	500 A	525 A	1000 A	1200 A
Maximum breaking capacity	at 440 V	2000 A	3000 A	3300 A	3500 A	3800 A	4600 A	5000 A	5400 A	-
cos $\phi = 0.45$	at 690 V	-	-	-	-	-	-	-	5400 A	-
Power dissipation per pole	I <sub>e</sub> / AC-1	12 W	18 W	15 W	25 W	32 W	50 W	72 W	60 W	80 W
	I <sub>e</sub> / AC-3	-	-	-	-	-	-	-	25 W	-
Max. electrical switching frequency	AC-1	300 cycles/h								
	AC-3	300 cycles/h								-
	AC-2, AC4	-								120 cycles/h

(1) For the corresponding kW/A or hp/A values of 1500 r.p.m. 50 Hz or 1800 r.p.m. 60 Hz, 3-phase motors, see "Motor rated operational powers and currents".

(2)  $\theta \leq 55^\circ\text{C}$  for EK550, EK1000

(3) For currents above 275 A use terminal enlargements or terminal extensions.

(4) For currents above 450 A use terminal enlargements or terminal extensions.



## AF09 ... AF80 4-pole contactors

### Technical data

#### Main pole - Utilization characteristics according to UL/NEMA/CSA

Contactor types	AC / DC operated	AF09	AF16	AF26	AF38	AF40	AF52	AF80
Standards		UL 508, CSA C22.2 N°14				UL 60947-4-1, CSA-C22.2 No. 60947-4-1		
Max. operational voltage		600 V						
UL / CSA general use rating								
	600 V AC	25 A	30 A	45 A	55 A	60 A	80 A	105 A
With conductor cross-sectional area		AWG 10	AWG 10	AWG 8	AWG 6	AWG 6	AWG 4	AWG 2
1 pole	80 V DC	25 A (1)	30 A (1)	45 A	55 A	60 A	80 A	105 A
2 poles in serie	160 V DC	25 A (1)	30 A (1)	45 A	55 A	60 A	80 A	105 A
3 poles in serie	240 V DC	25 A	30 A	45 A	55 A	60 A	80 A	105 A
4 poles in serie	320 V DC	25 A	30 A	45 A	55 A	60 A	80 A	105 A
With conductor cross-sectional area		AWG 10	AWG 10	AWG 8	AWG 8	AWG 6	AWG 4	AWG 2
Max. electrical switching frequency								
For general use		600 cycles/h						

Note: 4-pole contactors fitted with 2 N.O. + 2 N.C. main poles, see "General technical data".

(1) 20 A for AF09...22-00 and AF16...22-00.

#### Main pole utilization characteristics - 4 N.O. non-reversing contactors

Contactor types	AC / DC operated	AF09	AF16	AF26	AF38	AF40	AF52	AF80
Lighting application - UL / CSA - breaking all lines								
Electrical discharge lamps (ballast)								
1-phase per pole	347 V AC	20 A	30 A	45 A	50 A	-	-	-
3-phase break all lines	600 V AC	20 A	30 A	45 A	50 A	-	-	-
Elevator control, load switching, 500 000 electrical operating cycles acc. to CSA B44.1 / ASME 17.5 paragraph 19.2.1								
1-phase								
Horse power rating	110-120 V AC	-	1/2 hp	-	-	-	-	-
	220-240 V AC	-	1-1/2 hp	-	-	-	-	-
3-phase								
Horse power rating	200-208 V AC	-	3 hp	-	-	-	-	-
	220-240 V AC	-	3 hp	-	-	-	-	-
	440-480 V AC	-	7-1/2 hp	-	-	-	-	-
	550-600 V AC	-	10 hp	-	-	-	-	-

Note: 4-pole contactors fitted with 2 N.O. + 2 N.C. main poles, see "General technical data".

## AF116 ... EK1000 4-pole contactors

### Technical data

#### Main pole - Utilization characteristics according to UL/NEMA/CSA

Contactor types	AC / DC operated	AF116	AF140	AF190	AF205	AF265	AF305	AF370	EK550	EK1000
Standards		UL 60947-4-1							UL 508, CSA C22.2 N°14	
Max. operational voltage		600 V								
UL / CSA general use rating										
600 V AC		160 A	175 A	230 A	250 A	300 A	350 A	420 A	540 A	-
With conductor cross-sectional area		AWG 2/0	AWG 3/0	MCM 250	MCM 250	MCM 400	MCM 500	2//MCM 300	-	-
1 pole	90 V DC	200 A	200 A	-	-	-	-	-	-	-
	100 V DC	-	-	250 A	350 A	-	-	-	-	-
	110 V DC	-	-	-	-	400 A	500 A	520 A	-	-
2 poles in serie	175 V DC	200 A	200 A	-	-	-	-	-	-	-
	200 V DC	-	-	250 A	350 A	-	-	-	-	-
	225 V DC	-	-	-	-	400 A	500 A	520 A	-	-
3 poles in serie	260 V DC	200 A	200 A	-	-	-	-	-	-	-
	300 V DC	-	-	250 A	350 A	-	-	-	-	-
	340 V DC	-	-	-	-	400 A	500 A	520 A	-	-
4 poles in series	350 V DC	200 A	200 A	-	-	-	-	-	-	-
	400 V DC	-	-	250 A	350 A	-	-	-	-	-
	450 V DC	-	-	-	-	400 A	500 A	520 A	-	-
With conductor cross-sectional area		AWG 2/0	AWG 3/0	MCM 250	MCM 250	MCM 400	MCM 500	2//MCM 300	-	-
Max. electrical switching frequency										
For general use		300 cycles/h								

#### Main pole utilization characteristics - 4 N.O. non-reversing contactors

Contactor types	AC / DC operated	AF116	AF140	AF190	AF205	AF265	AF305	AF370	EK550	EK1000
Lighting application - UL/CSA - breaking all lines										
Electrical discharge lamps (ballast)										
1-phase per pole	347 V AC	160 A	200 A	250 A	300 A	400 A	450 A	520 A	-	-
3-phase break all lines	600 V AC	160 A	200 A	250 A	300 A	400 A	450 A	520 A	-	-

# AF09 ... AF80 4-pole contactors

## Technical data

### General technical data

Contactor types	AC / DC operated	AF09	AF16	AF26	AF38	AF40	AF52	AF80	
Rated insulation voltage Ui		690 V							1000 V
acc. to IEC 60947-4-1		600 V							
acc. to UL / CSA		6 kV							8 kV
Rated impulse withstand voltage Uimp.		Devices complying with IEC 60947-1 / EN 60947-1 - Environment A and B (1)							
Electromagnetic compatibility		-40...+70 °C							
Ambient air temperature close to contactor		-60...+80 °C							
Operation		Category B according to IEC 60947-1 Annex Q							
Climatic withstand		3000 m							
Maximum operating altitude (without derating)		10 millions operating cycles							
Mechanical durability		3600 cycles/h							
Number of operating cycles									
Max. switching frequency									
Shock withstand									
acc. to IEC 60068-2-27 and EN 60068-2-27									
Mounting position 1									
	Shock direction	1/2 sinusoidal shock for 11 ms: no change in contact position, closed or open position							
	4 N.O.	A 30 g		B1 25 g Closed position / 5 g Open position		20 g		20 g	
	Main poles	B2 15 g		C1 25 g		20 g		10 g	
		C2 25 g		30 g Closed position / 25 g Open position		20 g		20 g	
	2 N.O. + 2 N.C.	A 30 g		25 g Closed position / 5 g Open position		20 g Closed position / 5 g Open position		20 g Closed position / 4 g Open position	
	Main poles	B1 25 g Closed position / 5 g Open position		15 g Closed position / 10 g Open position		10 g		20 g	
		B2 15 g		25 g Closed position / 20 g Open position		20 g		20 g	
		C1 25 g		25 g Closed position / 20 g Open position		20 g		20 g	
		C2 25 g		5 ... 300 Hz		4 g Closed position / 2 g Open position		5 ... 300 Hz	
Vibration withstand		3 g Closed position / 2 g Open position		5 ... 300 Hz		3 g Closed position / 2 g Open position			
acc. to IEC 60068-2-6									

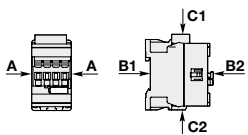

(1) Environment B: all AF09 ... AF38 contactors produced since week 08-2013.  
AF09 ... AF38-...-12 (48...130 V 50/60 Hz-DC) compliant to environment A only: for environment B select AF09Z ... AF38Z-...-22.

### Mounting characteristics and conditions for use

Contactor types	AF09	AF16	AF26	AF38	AF40	AF52	AF80
Mounting positions							
Mounting distances	Max. add-on N.C. auxiliary contacts: see accessory fitting details for a 4-pole contactor AF09 ... AF80						
Fixing	The contactors can be assembled side by side						
On rail according to IEC 60715, EN 60715	35 x 7.5 mm or 35 x 15 mm				35 x 15 mm		
By screws (not supplied)	2 x M4 screws placed diagonally				2 x M4 or 2 x M6 screws placed diagonally		

### Remark for 4-pole contactors fitted with 2 N.O. + 2 N.C. main poles

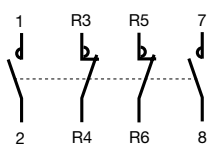

These contactors are suitable for controlling 2 separate circuits, i.e. 2 loads with 2 separate supplies, or 1 circuit comprising 2 separate loads with a single supply (see diagrams beside). When the contactor operates there is no mechanical overlapping between the N.O. poles and the N.C. poles: BREAK before MAKE.



These contactors are not suitable for a reversing starter or for controlling a single load from 2 separate supplies.

#### Block diagrams

- Single supply and 2 separate loads

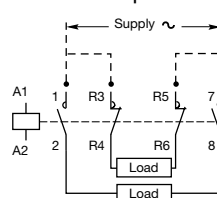

- 2 separate supplies and 2 separate loads

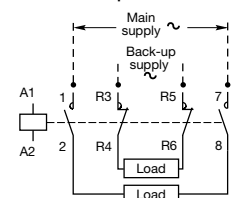

# AF116 ... EK1000 4-pole contactors

## Technical data

### General technical data

Contactor types	AC / DC operated	AF116	AF140	AF190	AF205	AF265	AF305	AF370
Rated insulation voltage Ui		1000 V						
acc. to IEC 60947-4-1		600 V						
acc. to UL / CSA		8 kV						
Rated impulse withstand voltage Uimp.		AF contactors comply with IEC 60947-1 / EN 60947-1 - Environment A						
Electromagnetic compatibility								
Ambient air temperature close to contactor								
Operation		-40 to +70 °C						
Storage		-40 to +70 °C						
Climatic withstand		Category B according to IEC 60947-1 Annex Q						
Maximum operating altitude (without derating)		3000 m						
Mechanical durability								
Number of operating cycles		5 million operating cycles						
Maximum switching frequency		300 cycles/h						
Shock withstand								
acc. to IEC 60068-2-27 and EN 60068-2-27		No change in contact position, closed or open position						
Mounting position 1								
Shock direction		1/2 sinusoidal shock for 11 ms			1/2 sinusoidal shock for 30 ms			
A		20 g			20 g			
B1		15 g closed position / 3 g open position			15 g closed position / 3 g open position			
B2		15 g closed position / 3 g open position			15 g closed position / 3 g open position			
C1		20 g			20 g			
C2		20 g			20 g			
Vibration withstand								
acc to IEC 60068-2-6		0.7 g closed position / 0.7 g open position 13.2...100 Hz						

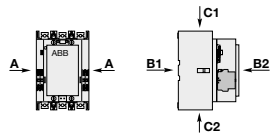

### General technical data

Contactor types	AC or DC operated	EK550	EK1000
Rated insulation voltage Ui		1000 V	
acc. to IEC 60947-4-1		600 V	
acc. to UL		8 kV	
Rated impulse withstand voltage Uimp.		EK contactors complying with IEC 60947-1 / EN 60947-1 - Environment A	
Electromagnetic compatibility			
Ambient air temperature close to contactor			
Operation	Fitted with thermal overload relay	-25 to +55 °C	-
	Without thermal overload relay	-40 to +70 °C	-
Storage		-50 to +70 °C	-
Climatic withstand		Category B acc. to IEC 60068-2-30	
Maximum operating altitude (without derating)		≤ 3000 m	
Mechanical durability			
Number of operating cycles		5 millions operating cycles	3 millions operating cycles
Max. switching frequency		60 cycles/h	
Shock withstand			
acc. to IEC 60068-2-27 and EN 60068-2-27		1/2 sinusoidal shock for 15 ms: no change in contact position, closed or open position	
Mounting position 1			
Closed or open position			
Shock direction		1/2 sinusoidal shock for 15 ms: no change in contact position, closed or open position	
A		10 g	
B1		10 g	
B2		10 g	
C1		10 g	
C2		10 g	

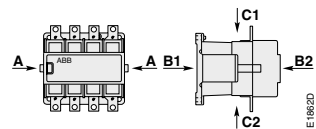

# AF09 ... AF80 4-pole contactors

## Technical data

### Magnet system characteristics AF09 ... AF80 AC / DC operated

Contactor types	AC / DC operated	AF09	AF16	AF26	AF38	AF40	AF52	AF80
Coil operating limits acc. to IEC 60947-4-1	AC supply	At $\theta \leq 60^\circ\text{C}$ $0.85 \times U_c \text{ min} \dots 1.1 \times U_c \text{ max}$ . At $\theta \leq 70^\circ\text{C}$ $0.85 \times U_c \text{ min} \dots U_c \text{ max}$ .				at $\theta \leq 70^\circ\text{C}$ $0.85 \times U_c \text{ min} \dots 1.1 \times U_c \text{ max}$		
	DC supply	at $\theta \leq 60^\circ\text{C}$ $0.85 \times U_c \text{ min} \dots 1.1 \times U_c \text{ max}$ at $\theta \leq 70^\circ\text{C}$ $0.85 \times U_c \text{ min} \dots U_c \text{ max}$				at $\theta \leq 70^\circ\text{C}$ $0.85 \times U_c \text{ min} \dots 1.1 \times U_c \text{ max}$		
AC control voltage 50/60 Hz		24...500 V AC						
Rated control circuit voltage $U_c$		24...500 V AC						
Coil consumption	Average pull-in value	50 VA				40 VA		
	Average holding value	2.2 VA / 2 W				4 VA / 2 W		
DC control voltage		20...500 V DC				20...500 V DC		
Rated control circuit voltage $U_c$		20...500 V DC				20...500 V DC		
Coil consumption	Average pull-in value	50 W				40 W		
	Average holding value	2 W				2 W		
PLC-output control		AF...11 not suitable for direct control by PLC-output.				-		
Drop-out voltage		$\leq 60\%$ of $U_c \text{ min}$ .				$\leq 60\%$ of $U_c \text{ min}$ .		
Voltage sag immunity acc. to SEMI F47-0706		-				conditions of use on request		
Dips withstand $-20^\circ\text{C} \leq \theta \leq +60^\circ\text{C}$		-				20 ms average		
Operating time								
Between coil energization and:	N.O. contact closing	40...95 ms				48...120 ms		
	N.C. contact opening	38...90 ms				44...115 ms		
Between coil de-energization and:	N.O. contact opening	11...95 ms				16...110 ms		
	N.C. contact closing	13...98 ms				18...113 ms		

### Magnet System Characteristics AF09Z...AF38Z 24V DC operated designed for PLC - coil 30

Contactor types	DC operated	AF09Z	AF16Z
Coil operating limits acc. to IEC 60947-4-1	DC supply	at $\theta \leq 60^\circ\text{C}$ $0.85 \dots 1.1 \times U_c$ at $\theta \leq 70^\circ\text{C}$ $U_c$	
DC control voltage		24 V DC	
Rated control circuit voltage $U_c$		24 V DC	
Coil consumption	Average pull-in value	6 W	
	Average holding value	1.7 W	
PLC-output control		$\geq 250 \text{ mA}$ 24 V DC for PLCs and safety PLCs using broken wire detection	
Drop-out voltage		$\leq 60\%$ of $U_c \text{ min}$ .	
Voltage sag immunity acc. to SEMI F47-0706		-	
Dips withstand $-20^\circ\text{C} \leq \theta \leq +60^\circ\text{C}$		-	
Operating time			
Between coil energization and:	N.O. contact closing	27 ... 53 ms	
	N.C. contact opening	20 ... 35 ms	
Between coil de-energization and:	N.O. contact opening	17 ... 29 ms	
	N.C. contact closing	22 ... 57 ms	

### Magnet System Characteristics AF09Z...AF38Z AC / DC operated for specific applications - coils 20, 21, 22, 23

Contactor types	AC / DC operated	AF09Z	AF16Z	AF26Z	AF38Z
Coil operating limits acc. to IEC 60947-4-1	AC supply	At $\theta \leq 60^\circ\text{C}$ $0.85 \times U_c \text{ min} \dots 1.1 \times U_c \text{ max}$ . At $\theta \leq 70^\circ\text{C}$ $0.85 \times U_c \text{ min} \dots U_c \text{ max}$ .			
	DC supply	at $\theta \leq 70^\circ\text{C}$ $0.85 \times U_c \text{ min} \dots 1.1 \times U_c \text{ max}$			
AC control voltage 50/60 Hz		24...250 V AC			
Rated control circuit voltage $U_c$		24...250 V AC			
Coil consumption	Average pull-in value	16 VA			
	Average holding value	1.7 VA / 1.5 W			
DC control voltage		12...250 V DC			
Rated control circuit voltage $U_c$		12...250 V DC			
Coil consumption	Average pull-in value	12 ... 16 W			
	Average holding value	1.7 W			
PLC-output control		(AF..Z coil 21) $\geq 500 \text{ mA}$ 24 V DC for PLCs - Not suitable for safety PLCs			
Drop-out voltage		$\leq 60\%$ of $U_c \text{ min}$ .			
Voltage sag immunity acc. to SEMI F47-0706		(AF..Z coil 21, 22, 23) conditions of use on request			
Dips withstand $-20^\circ\text{C} \leq \theta \leq +60^\circ\text{C}$		(AF..Z coil 21, 22, 23) 20 ms average for $U_c \geq 24 \text{ V}$ 50/60 Hz or $U_c \geq 20 \text{ V DC}$			
Operating time					
Between coil energization and:	N.O. contact closing	40...95 ms			
	N.C. contact opening	38...90 ms			
Between coil de-energization and:	N.O. contact opening	11...95 ms			
	N.C. contact closing	13...98 ms			

03

## AF116 ... AF370 4-pole contactors

### Technical data

#### Magnet system characteristics

Contactor types	AC / DC operated	AF116	AF140	AF190	AF205	AF265	AF305	AF370
Coil operating limits	AC supply	At $\theta \leq 70^\circ\text{C}$ $0.85 \times U_c \text{ min} \dots 1.1 \times U_c \text{ max}$						
acc. to IEC 60947-4-1	DC supply	At $\theta \leq 70^\circ\text{C}$ $0.80 \times U_c \text{ min} \dots 1.1 \times U_c \text{ max}$						
Rated control circuit voltage $U_c$		24...500 V AC, 20...500 V DC						
Coil consumption								
AC control voltage 50/60 Hz								
24...60 V AC	Average pull-in value	225 VA		165 VA		475 VA		
	Average holding value	5.5 VA		6 VA		8.5 VA		
48...130 V AC	Average pull-in value	170 VA		175 VA		340 VA		
	Average holding value	4 VA		4 VA		17 VA		
100...250 V AC	Average pull-in value	130 VA		220 VA		385 VA		
	Average holding value	6 VA		7 VA		17.5 VA		
250...500 V AC	Average pull-in value	205 VA		185 VA		420 VA		
	Average holding value	16 VA		16 VA		21 VA		
DC control voltage								
20...60 V DC	Average pull-in value	210 W		205 W		400 W		
	Average holding value	2.5 W		2.5 W		3.5 W		
48...130 V DC	Average pull-in value	130 W		130 W		360 W		
	Average holding value	2.5 W		2.5 W		2.5 W		
100...250 V DC	Average pull-in value	135 W		190 W		410 W		
	Average holding value	3 W		2.5 W		4.5 W		
250...500 V DC	Average pull-in value	205 W		190 W		600 W		
	Average holding value	4 W		4 W		4.7 W		
Drop-out voltage		55 % of $U_c \text{ min}$						
Voltage sag immunity		Conditions of use on request						
acc. to SEMI F47								
Dips withstand		20 ms						
Operating time								
Coil supply between A1 - A2								
Between coil energization and:	N.O. contact closing	20...55 ms		25...60 ms		30...60 ms		
Between coil de-energization and:	N.O. contact opening	40...70 ms		45...80 ms		45...80 ms		

#### Mounting characteristics and conditions for use

Contactor types	AC / DC operated	AF116	AF140	AF190	AF205	AF265	AF305	AF370
Mounting positions		<p>Max. add-on N.O. or N.C. auxiliary contacts: see accessory fitting details for 4-pole contactor AF116 ... AF370</p>						
Mounting distances		The contactors can be assembled side by side						
Fixing								
On rail acc. to IEC 60715, EN 60715		-						
By screws		4 x M4			4 x M5			

# EK550 ... EK1000 4-pole contactors

## Technical data

### Magnet system characteristics

Contactor types	AC operated	EK550	EK1000
Coil operating limits acc. to IEC 60947-4-1	AC supply	At $\theta \leq 70^\circ\text{C}$ $0.85 \times U_c \text{ min} \dots 1.1 \times U_c \text{ max}$ .	
AC control voltage		Please also refer to "Mounting characteristics and conditions for use"	
Rated control circuit voltage	50 Hz	48...500 V	
	60 Hz	110...600 V	
Coil consumption	Average pull-in value	50 Hz	3500 VA
		60 Hz	4000 VA
	50/60 Hz (1)	3800 / 3400 VA	
	Average holding value	50 Hz	125 VA / 50 W
60 Hz		140 VA / 60 W	
50/60 Hz (1)	140 VA / 60 W		
Drop-out voltage in % of $U_c \text{ min}$ .		approx. 45...65 %	
Operating time			
Between coil energization and:	N.O. contact closing	30...60 ms	
	N.C. contact opening	25...55 ms	
Between coil de-energization and:	N.O. contact opening	10...20 ms	
	N.C. contact closing	13...23 ms	

(1) "A" coil voltage: see "Coil voltage code table".

### Magnet system characteristics

Contactor types	DC operated	EK550	EK1000
Coil operating limits acc. to IEC 60947-4-1	DC supply	At $\theta \leq 70^\circ\text{C}$ $0.85 \times U_c \text{ min} \dots 1.1 \times U_c \text{ max}$ .	
DC control voltage		Please also refer to "Mounting characteristics and conditions for use"	
Rated control circuit voltage		24...220 V	
Coil consumption	Average pull-in value	1100 W	
	Average holding value	20 W	
Drop-out voltage		approx. 15...50 % of $U_c \text{ min}$ .	
Coil time constant			
Open	L/R	12 ms	
Closed	L/R	60 ms	
Operating time			
Between coil energization and:	N.O. contact closing	60...80 ms	
	N.C. contact opening	55...75 ms	
Between coil de-energization and:	N.O. contact opening	10...35 ms	
	N.C. contact closing	13...38 ms	

### Mounting characteristics and conditions for use











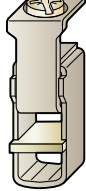
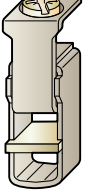
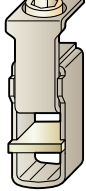



Contactor types	AC / DC operated	EK550	EK1000
Mounting positions			
Control voltage / Ambient temperature		Max. N.O. or N.C. built-in and add-on N.O. or N.C. auxiliary contacts: see accessory fitting details for 4-pole contactor EK550, EK1000	
Mounting positions		at $\theta \leq 70^\circ\text{C}$	$0.85 \dots 1.1 \times U_c$
		at $\theta \leq 70^\circ\text{C}$	Unauthorized
Mounting distances		The contactors can be assembled side by side	
Fixing			
On rail according to IEC 60715, EN 60715		-	
By screws		4 x M6 (2)	

(2) Damping elements are supplied.

# AF09 ... AF80 4-pole contactors

## Technical data

### Connecting characteristics

Contactors types	AF09	AF16	AF26	AF38	AF40	AF52	AF80
Main terminals	 Screw terminals with cable clamp		 Screw terminals with double connector 2 x (5.5 width x 6.8 depth)		 Screw terminals with double connector 2 x (9.3 width x 7.9/10.3 depth)		 Screw terminals with double connector 2 x (12.4 width x 9.3/11.1 depth)
Connection capacity (min. ... max.)							
Main conductors (poles)							
 Rigid Solid ( $\leq 4 \text{ mm}^2$ )	1 x	1...6 mm <sup>2</sup>	1.5...16 mm <sup>2</sup>		6...35 mm <sup>2</sup>		6...70 mm <sup>2</sup>
 Stranded ( $\geq 6 \text{ mm}^2$ )	2 x	1...6 mm <sup>2</sup>	1.5...16 mm <sup>2</sup>		6...35 mm <sup>2</sup>		6...50 mm <sup>2</sup>
 Flexible with non insulated ferrule	1 x	0.75...6 mm <sup>2</sup>	1.5...16 mm <sup>2</sup>		4...35 mm <sup>2</sup>		6...50 mm <sup>2</sup>
 Flexible with insulated ferrule	2 x	0.75...6 mm <sup>2</sup>	1.5...16 mm <sup>2</sup>		4...35 mm <sup>2</sup>		6...50 mm <sup>2</sup>
 Flexible with insulated ferrule	1 x	0.75...4 mm <sup>2</sup>	1.5...16 mm <sup>2</sup>		4...35 mm <sup>2</sup>		6...50 mm <sup>2</sup>
 Flexible with insulated ferrule	2 x	0.75...2.5 mm <sup>2</sup>	1.5...16 mm <sup>2</sup>		4...35 mm <sup>2</sup>		6...50 mm <sup>2</sup>
 Bars or lugs	L <	9.6 mm	-		9.2 mm		12.2 mm
Connection capacity acc. to UL/CSA	1 or 2 x	AWG 16...10	AWG 16...6		AWG 10...2		AWG 6...1
Stripping length		10 mm	12 mm		16 mm		17 mm
Tightening torque		1.5 Nm / 13 lb.in	2.5 Nm / 22 lb.in		4 Nm / 35 lb.in		6 Nm / 53 lb.in
Auxiliary conductors (coil terminals)							
 Rigid solid	1 x	1...2.5 mm <sup>2</sup>					
 Rigid solid	2 x	1...2.5 mm <sup>2</sup>					
 Flexible with non insulated ferrule	1 x	0.75...2.5 mm <sup>2</sup>					
 Flexible with non insulated ferrule	2 x	0.75...2.5 mm <sup>2</sup>					
 Flexible with insulated ferrule	1 x	0.75...2.5 mm <sup>2</sup>					
 Flexible with insulated ferrule	2 x	0.75...1.5 mm <sup>2</sup>					
 Lugs	L <	8 mm					
Connection capacity acc. to UL/CSA	1 or 2 x	AWG 18...14					
Stripping length		10 mm					
Tightening torque		1.2 Nm / 11 lb.in					
Degree of protection acc. to IEC 60947-1 / EN 60947-1 and IEC 60529 / EN 60529							
Main terminals	IP20				IP10 *		
Coil terminals	IP20						
Screw terminals	Delivered in open position, screws of unused terminals must be tightened						
Main terminals		M3.5	M4.5		M6		M8
	Screwdriver type	Flat Ø 5.5 / Pozidriv 2			Flat Ø 6.5 / Pozidriv 2		hexagon socket (s = 4 mm)
Coil terminals		M3.5					
	Screwdriver type	Flat Ø 5.5 / Pozidriv 2					











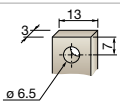
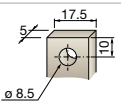
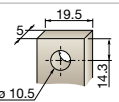

\* For IP20 degree of protection, use LT terminal shroud accessory.



# AF116 ... AF370 4-pole contactors

## Technical data

### Connecting characteristics

Contactor types	AC / DC operated	AF116	AF140	AF190	AF205	AF265	AF305	AF370
Main terminals								
Flat type								
Connection capacity (min. ... max.)								
Main conductors (poles)								
 Cu cable - Stranded	1 x	10...95 mm <sup>2</sup>		6...150 mm <sup>2</sup>		16...300 mm <sup>2</sup>		
Clamp type		LD... included (1)		1SDA066917R1		1SDA055016R1		
Tightening torque		8 Nm		14 Nm		25 Nm		
 Cu cable - Stranded	2 x	10...95 mm <sup>2</sup>		50...120 mm <sup>2</sup>		70...185 mm <sup>2</sup>		
Clamp type		LD... included (1)		1SFN074709R1000, LZ185-2C/120		1SCA022194R0890, OZXB4		
Tightening torque		8 Nm		16 Nm		22 Nm		
 Al cable - Stranded	1 x	-		95...185 mm <sup>2</sup>		185...240 mm <sup>2</sup>		
Clamp type		-		1SDA054988R1		1SDA055020R1		
Tightening torque		-		31 Nm		43 Nm		
 Cu cable - Flexible	1 x	10...70 mm <sup>2</sup>		6...120 mm <sup>2</sup>		16...240 mm <sup>2</sup>		
Clamp type		LD... included (1)		1SDA066917R1		1SDA055016R1		
Tightening torque		8 Nm		14 Nm		25 Nm		
 Cu cable - Flexible	2 x	10...70 mm <sup>2</sup>		50...95 mm <sup>2</sup>		70...185 mm <sup>2</sup>		
Clamp type		LD... included (1)		1SFN074709R1000, LZ185-2C/120		1SCA022194R0890, OZXB4		
Tightening torque		8 Nm		16 Nm		22 Nm		
 Lugs	L ≤	22 mm (.866 in)		24 mm (.945 in)		32 mm (1.260 in)		
	Ø >	6 mm (.236 in)		8 mm (.315 in)		10 mm (.394 in)		
Socket type		LL... included		LL... included		LL... included		
Tightening torque		9 Nm / 80 lb.in		18 Nm / 160 lb.in		28 Nm / 248 lb.in		
Connection capacity acc. to UL / CSA	1 x	AWG 6...3/0		6...300 MCM		4...400 MCM		
Clamp type		LD... included (1)		ATK185 (2)		ATK300 (2)		
Tightening torque		8 Nm / 71 lb.in		34 Nm / 301 lb.in		42 Nm / 372 lb.in		
Connection capacity acc. to UL / CSA	2 x	AWG 6...3/0		-		4...500 MCM		
Clamp type		LD... included (1)		-		ATK300/2 (2)		
Tightening torque		8 Nm / 71 lb.in		-		42 Nm / 372 lb.in		
Auxiliary conductors (coil terminals)								
 Solid / stranded	1 x	1...4 mm <sup>2</sup>						
	2 x	1...4 mm <sup>2</sup>						
 Flexible	1 x	0.75...2.5 mm <sup>2</sup>						
	2 x	0.75...2.5 mm <sup>2</sup>						
 Flexible with non insulated ferrule	1 x	0.75...2.5 mm <sup>2</sup>						
	2 x	0.75...2.5 mm <sup>2</sup>						
 Flexible with insulated ferrule	1 x	0.75...2.5 mm <sup>2</sup>						
	2 x	0.75...2.5 mm <sup>2</sup>						
 Lugs	L <	8 mm						
	I >	3.5 mm						
Connection capacity acc. to UL / CSA	1 or 2 x	AWG 18...14						
Stripping length		9 mm						
Tightening torque		1.00 Nm / 9 lb.in						
Degree of protection acc. to IEC 60947-1 / EN 60947-1 and IEC 60529 / EN 60529								
Main terminals		IP00						
Coil terminals		IP20						
Screw terminals								
Main terminals		M6		M8		M10		
Screwdriver type		Screws and bolts						
Coil terminals (delivered in open position)		M3.5						
Screwdriver type		Flat Ø 5.5 mm / Pozidriv 2						







(1) LD... not included for AF116 ... AF146-30-...B.

(2) Available in North America only.

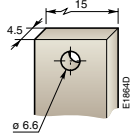
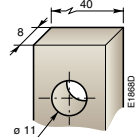
## EK550 ... EK1000 4-pole contactors

### Technical data

#### Connecting characteristics

Contactor types	AC or DC operated	EK550	EK1000
Main terminals Flat type			
Connection capacity (min. ... max.)			
Main conductors (poles)			
 Rigid with connector	Cu cable	1 x 70...300 mm <sup>2</sup>	-
	Al/Cu cable	1 x 70...300 mm <sup>2</sup>	95...300 mm <sup>2</sup>
	Al/Cu cable	2 x 35...185 mm <sup>2</sup>	95...300 mm <sup>2</sup>
 Bars or lugs		L ≤ 55 mm Ø > 10 mm	
Connection capacity acc. to UL/CSA	1 or 2 x	3 x 4 - 500 MCM	-
Tightening torque	Recommended	18 Nm / 160 lb.in	
	Max.	22 Nm	
Auxiliary conductors (coil terminals)			
 Rigid solid		1 x 0.5...2.5 mm <sup>2</sup>	
		2 x 0.5...2.5 mm <sup>2</sup>	
 Flexible with ferrule		1 x 0.5...2.5 mm <sup>2</sup>	
		2 x 0.5...2.5 mm <sup>2</sup>	
 Bars or lugs		L ≤ 8 mm l > 3.7 mm	
Connection capacity acc. to UL/CSA	1 or 2 x	18...14 AWG	
Tightening torque	Recommended	1.00 Nm / 9 lb.in	
	Max.	1.20 Nm	
Degree of protection acc. to IEC 60947-1 / EN 60947-1 and IEC 60529 / EN 60529			
Main terminals		IP00	
Coil terminals		IP20	
Screw terminals			
Main terminals		M10 Screws and bolts	
Coil terminals (delivered in open positions)		M3.5	
	Screwdriver type	Flat Ø 5.5 mm / Pozidriv 2	

## 4-pole contactors

### Electrical durability and utilization categories

#### General

Utilization categories determine the current making and breaking conditions relating to the characteristics of the loads to be controlled by the contactors. International standard IEC 60947-4-1 and European standard EN 60947-4-1 are the standards to be referred to.

If  $I_c$  is the current to be broken by the contactor and  $I_e$  the rated operational current normally drawn by the load, then:

- Categories AC-1:  $I_c = I_e$

Generally speaking  $I_c = m \times I_e$  where  $m$  is a multiple of the load operational current.

On next pages, the curves corresponding to categorie AC-1 represent the electrical durability variation of standard contactors in relation to the breaking current  $I_c$ .

#### Electrical durability curves:

- categories AC-1: the curves represent the electrical durability variation of standard contactors in relation to the breaking current  $I_c$ .

Electrical durability is expressed in millions of operating cycles.

#### Curve utilization mode

##### Electrical durability forecast and contactor selection for categories AC-1

- Note the characteristics of the load to be controlled:
  - Operational voltage.....  $U_e$
  - Current normally drawn.....  $I_e$  ( $U_e / I_e$  / kW relation for motors, see "Motor rated operational powers and currents").
  - Utilization category..... AC-1
  - Breaking current.....  $I_c = I_e$  for AC-1
- Define the number of operating cycles  $N$  required.
- On the diagram corresponding to the operational category, select the contactor with the curve immediately above the intersection point ( $I_c$  ;  $N$ ).

#### Case of uninterrupted duty

For uninterrupted duty, some verifications of preventing maintenance are necessary to check the functionality of the concerned product (consult us).

The combined effect of environmental conditions and the proper temperature of the product may require some disposals. As a matter of fact, for this duty, the use duration prevails over the number of operating cycles.

# 4-pole contactors

## Electrical durability

### Electrical durability for AC-1 utilization category - $U_e \leq 690\text{ V}$

Switching non-inductive or slightly inductive loads. The breaking current  $I_c$  for AC-1 is equal to the rated operational current of the load.

Ambient temperature and maximum electrical switching frequency: see "Technical data".

