



ACOLED2/CCT/M3

Comfort LED CCT Downlight Emergency 22W



Features

Economic high performance IP44 downlight

Deep cut-off angle for glare control and comfort

Osram LED technology and enhanced diffuser design for outstanding uniformity

One product provides both 3000K and 4000K colour temperature options

Downlight design allows installation into existing hole cut-outs from 200mm to 220mm

Polycarbonate housing with unique thermal management for durability and optimum lifespan

LED lifespan L70 50,000 hours

Dimmable and Emergency options

General Information

Lamp Type	LED
Colour / Finish	White
Emergency	Yes
IP Rating	IP44
Class Protection	2
Internal / External	Internal
Surface / Recessed / Suspended	Recessed
Warranty (Years)	5
CE Mark	Yes
Diameter (mm)	230
Height (mm)	100

Technical Information

Wattage	22W
Lumens Delivered	2241lm (Cool White), 2017lm (Warm White)
Lm/W	102lm (Cool White), 92lm (Warm White)
Beam Angle	60
CRI	Ra 80
CCT	3000K/4000K
Input	230V
Hertz	50Hz
Operating Temp	-20°C to 25°C

Technical Data - ETIM - Downlight/spot/floodlight (EC001744)

Suitable for surface mounting	No
Suitable for built-in mounting	Yes
Suitable for wall mounting	No
Suitable for suspended mounting	No
Suitable for ceiling mounting	Yes
Suitable for traverse mounting	No
Suitable for pedestal/floor mounting	No
Suitable for light-track mounting	No
Adjustability	Not adjustable
With movement sensor	No
With light sensor	No
With light source	Yes
Suitable for number of lamps	1
Material housing	Plastic
Colour housing	White
Nominal voltage	230-230 V
Control gear included	Yes
Beam angle	Wide beam 41-80°
Degree of protection (IP)	IP44
Protection class	II
Max. system power	22 W
Colour of light	White
Colour temperature	3000-4000 K
Colour rendering index CRI	80-89
Luminous flux	2017-2241 lm

Lamp efficacy 102 lm/W

Width 230 mm

Height/depth 100 mm

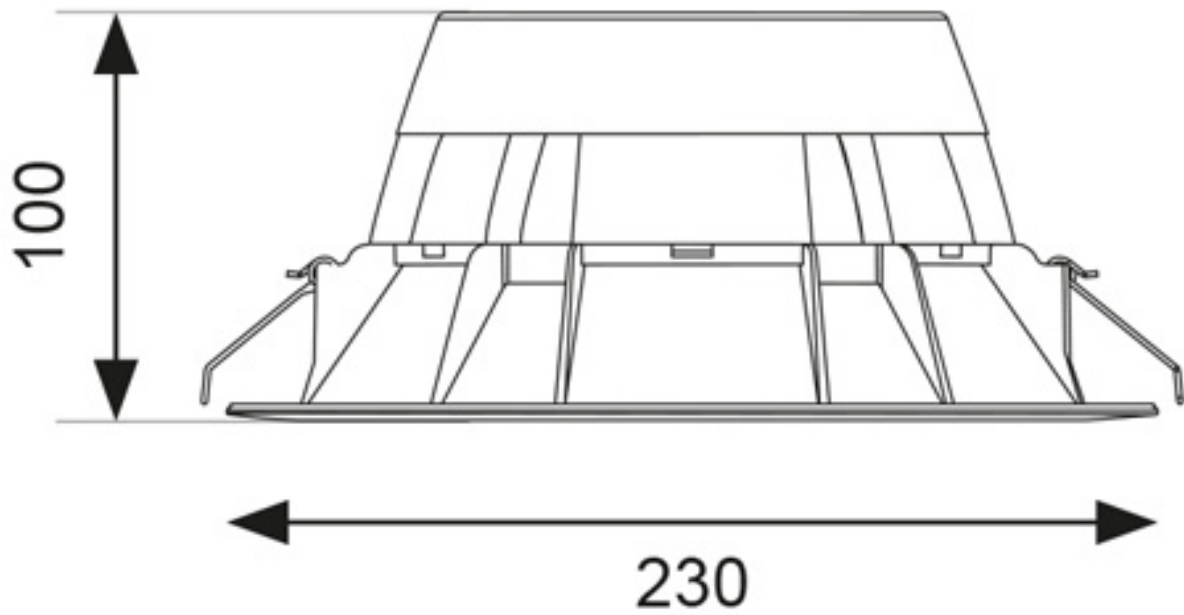

Datasheet generated from <https://onetimepim.com> last updated Tuesday, June 23, 2020 10:28:11 AM