

788/SKV 16

Jointing sleeve, IP68, plastic

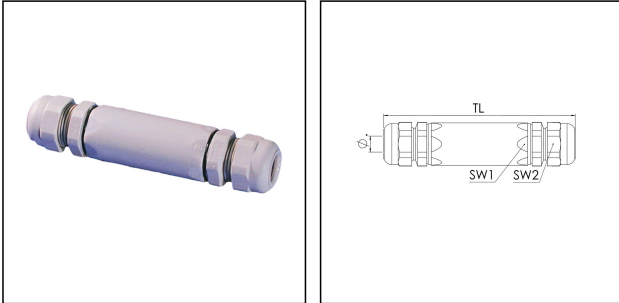

Products may differ in size, colour and appearance to those shown. If you require further information or customisation, please contact us directly.



Material	Polystyrole, flame-retardant
Material cable gland	Polyamide
Temp. range min	-25 °C
Temp. range max	60 °C
Protection class	IP68 (5 bar 30 min)
Glow wire test	750 °C
Terminals/poles	5 x 2,5 mm ²
Ø cable diameter min	8 mm
Ø cable diameter max	14 mm
Key width SW1	26 mm
Key width SW2	27 mm
Product Color	RAL 7035
Total length TL	134 mm
Order no. RAL 7035	10061462
Type	788/SKV 16
Packing unit	15
ETIM-Classification	EC001169

13.10.2020

Your Contact:

WISKA UK Ltd.

Unit 7, Hurling Way · St. Columb Major Business Park · TR9 6SX, St. Columb Major, Cornwall · Great Britain

☎ +44-12-08816062 · 📠 +44-12-08816708

info@wiska.co.uk · www.wiska.co.uk

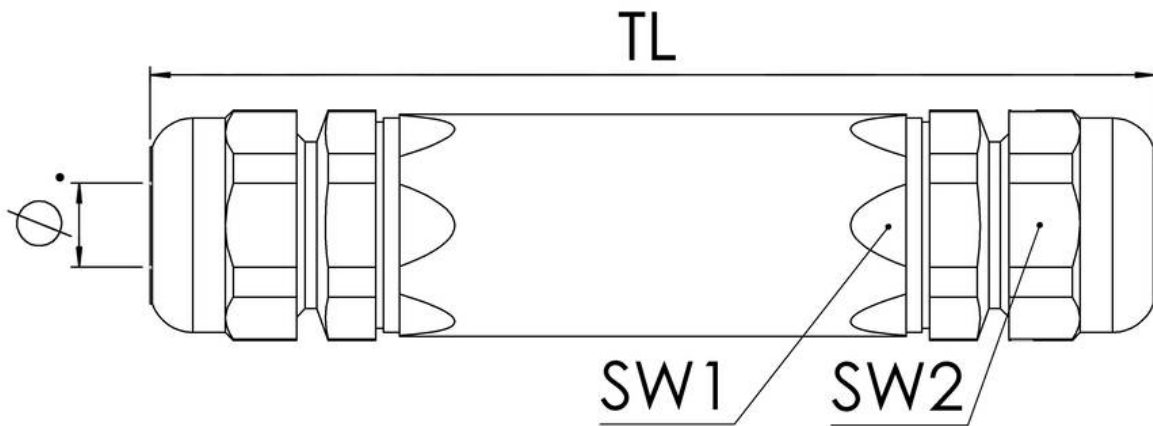

Your Contact:

WISKA UK Ltd.

Unit 7, Hurling Way · St. Columb Major Business Park · TR9 6SX, St. Columb Major, Cornwall · Great Britain

☎ +44-12-08816062 · 📠 +44-12-08816708

info@wiska.co.uk · www.wiska.co.uk