

Product Code: OV10110BKCWPIR

Description: 10W LED Floodlight With PIR - IP44 - 4000K - Black

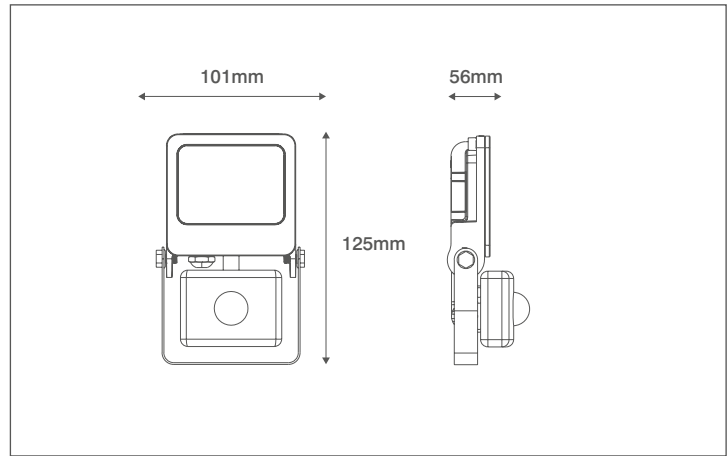

General Information

Dimensions	101mm (W) x 157mm (H) x 56mm (D)
Materials	Body: Powdercoated Aluminium Diffuser: Prismatic Glass
Finish	Black (RAL 9004)
Product Weight	0.315Kg
Dimmable	No
Ingress Protection	IP44
IK Rating	IK06
Warranty	3 Years

Supply & Power

Input Voltage & Frequency	240V~ 50/60Hz
Electrical Safety	Class I
Input Power	10W
Input Current	46mA
Inrush Current	0.036A (84µs)
Power Factor	0.9
Ambient Temperature (Ta)	-10°C - +45°C
Critical Temperature	-40°C - +70°C
Input Mains Cable	3 x 1mm ² H05-RNF (1 Metre)

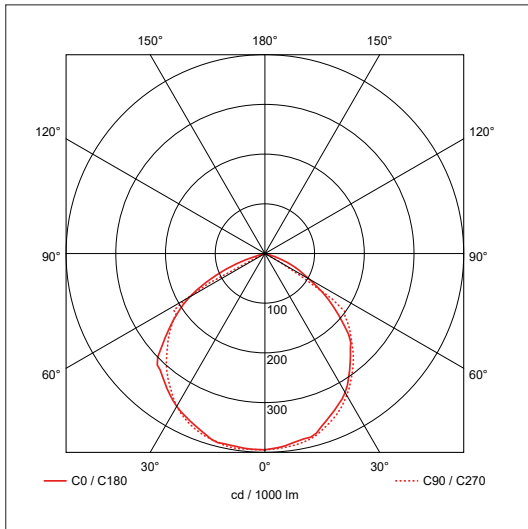

Luminaire Output

Colour Temperature	4000K
CRI	>80
Typical Luminous Flux	800lm
Efficacy	80lm/W
Beam Angle	110°
LED Lifetime (L70)	30,000 Hours

PIR Information

Detection Angle	180°
Detection Distance	10 Metres
Time Delay	10 Seconds - 10 Minutes
Lux Level	2 Lux Minimum 2000 Lux (Maximum)