



Commercial Specification Guide



Contents

Introduction	1
Saving Energy	2
How the Components Connect Together	3
Load – Controlling Devices	6
Keypads	11
Sensors	13
Interfaces and Programming Interfaces	18
Processor and Server	22
Software	23
Software & Client Licences	26
CCP – Custom Combination Panels	27
CCP – Modules for Panels	30
Shades	32
Power Supply	40
System/Wiring Diagrams	42
QS Link Limits Table	57
QS Link Wiring	59
Where to Find Us	60

Introduction

Lutron® Specialists in Light Control



Lutron has been innovating the solid-state dimmer switch design since 1961. We now offer an unrivalled range of light control products – from dimmers to shades and blinds to fully automated, fully integrated systems for a whole house. With over 15,000 ways to handle light, we will deliver a truly individual solution for home or business.

No-one has put more thought into how life can be enhanced thanks to the precise control of light. We employ hundreds of qualified engineers. And it is their tireless mission to constantly improve on light control. The result? Lutron has celebrated innovation by filing over 2,000 patents worldwide.

This consistent inventiveness is matched by product excellence and quality control. Every single one of our products is subjected to the industry's toughest testing and backed by equally robust guarantees.

With Lutron, you enjoy the many aesthetic, practical and monetary benefits of light control. With exact mastery over daylight and electric light, you can give each room its own look and feel.

Our keypad faceplates and the fabrics for our shades are available in a wide choice of colours and finishes – to blend harmoniously with your décor. Interior designers appreciate that elegance has always been the hallmark of our approach.

It is hardly surprising, therefore, that for many of the world's leading specifiers, Lutron is not the first choice, but the only choice.

Saving Energy



We appreciate that the environment, and particularly the use of energy, is of increasing concern to us all. And while there's much work still to be done in this field, Lutron technology is already making a significant contribution.

We estimate that our customers save 9 billion Kwh of energy a year. That's enough to light 4.5 million homes for a year* or power and illuminate New York's Times Square for a decade†. Put another way, this is saving as much energy as 2,000 windmills would produce in twelve months.

For us, energy efficiency is not a fad, but at the heart of everything we do. As the inventors of the original solid-state dimmer, we have pioneered the value of dimming technology – using a dimmer can extend the life of a light bulb by up to 10 times.

Lutron's shades play their part, too. Controlling daylight can reduce the cost of heating or cooling a house.

Beyond the home, our products are used to manage the use of natural and electric light in offices, schools and hospitals, helping to save energy – and save money that can be put to better use.

There's no question that controlling light helps reduce our impact on the wider environment. But rather than diminish our own, immediate environment, with Lutron light control, it becomes even more comfortable and stylish.

* Sources: Massachusetts Institute of Technology (MIT); US Department of Energy and Lutron sales data.

† As above plus Con Edison

How the Components Connect Together



Lutron offers a wide range of energy savings solutions. Our products and systems are easily installed in either new construction or existing buildings and expandable from a single room to an entire building or campus.

The following spread will give you an overview of all the products featured in this specification guide. This is one commercial example of many possible combinations.

How the Components Connect Together

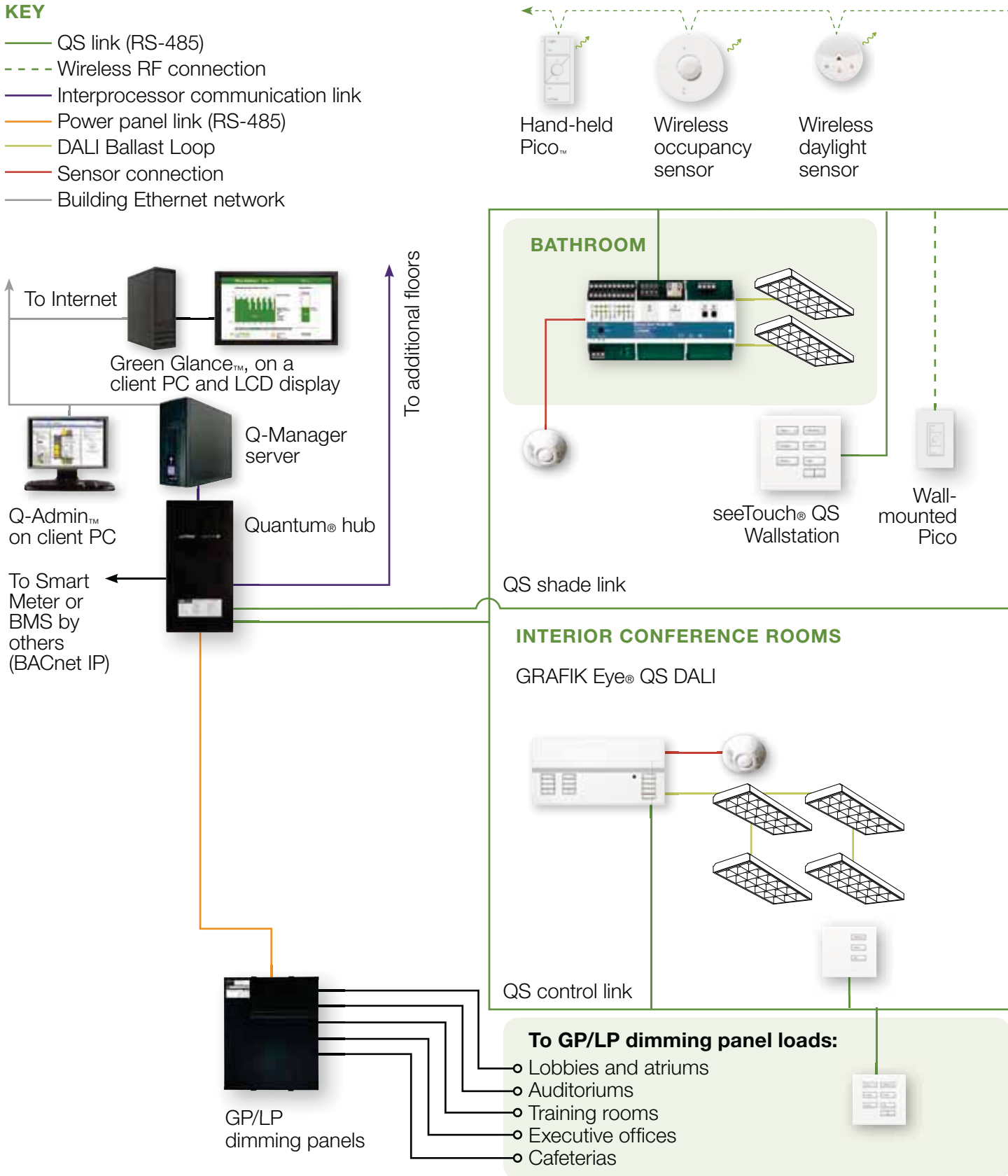

KEY

- QS link (RS-485)
- - - Wireless RF connection
- Interprocessor communication link
- Power panel link (RS-485)
- DALI Ballast Loop
- Sensor connection
- Building Ethernet network

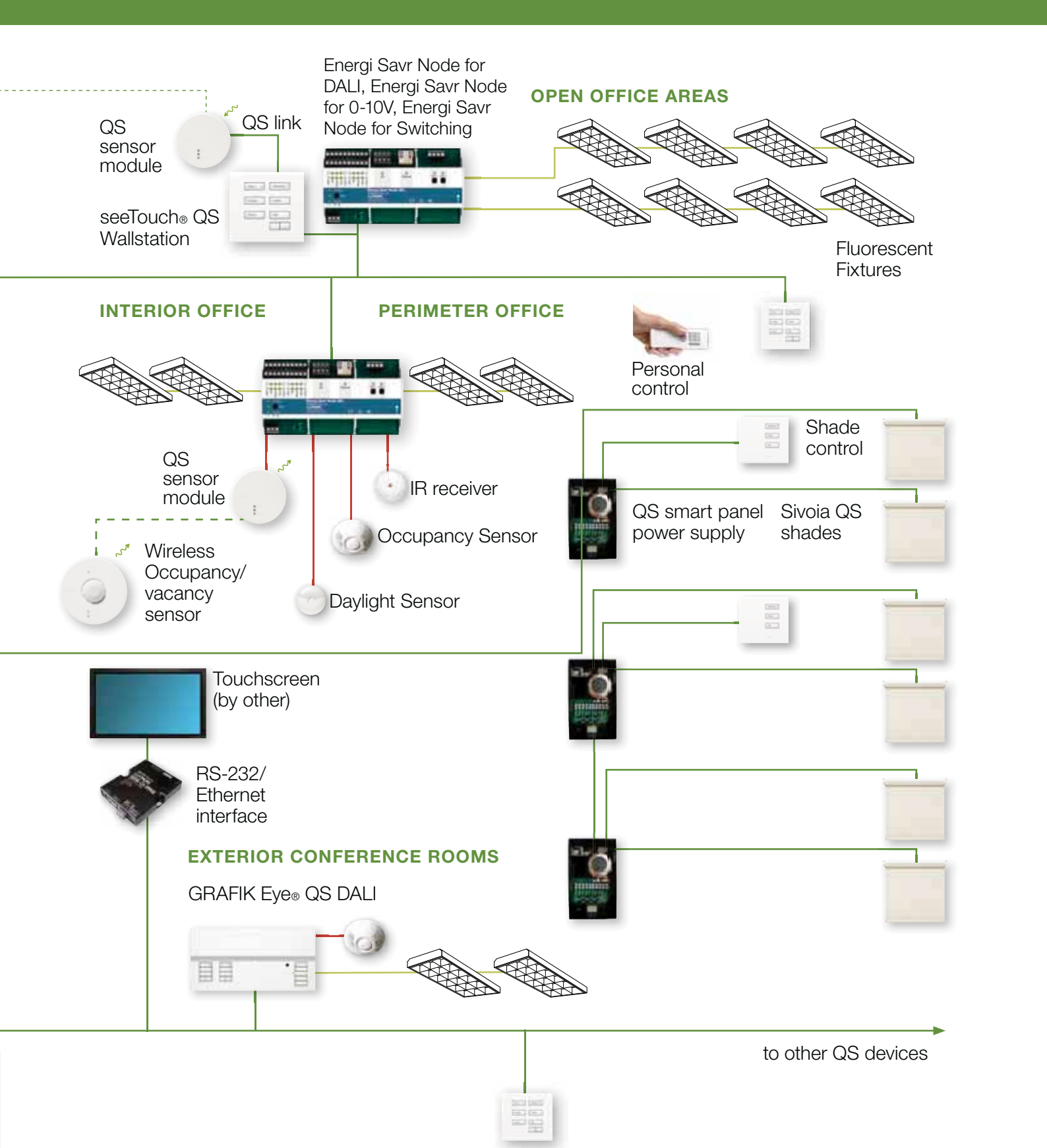



Load – Controlling Devices

Product	Features	
	<p>GRAFIK EYE QS WIRELESS AND GRAFIK EYE QS WIRELESS DALI</p> <p>GRAFIK Eye QS* Wireless is the premier energy-saving light and shade control. GRAFIK Eye QS includes an astronomic timeclock, intuitive lighting presets, and direct shade control. Now with wireless technology, you can use the GRAFIK Eye QS Wireless to seamlessly integrate with a variety of Lutron wireless products and systems, including Radio Powr Savr™ occupancy, vacancy, and daylight sensors, Sivoia® QS Wireless shades, Pico® wireless control, and other GRAFIK Eye QS Wireless control units. Additionally, the GRAFIK Eye QS Wireless is compatible with all Lutron wired QS products and systems. GRAFIK Eye QS Wireless is compatible with Quantum®.</p>	<p>GRAFIK EYE QS WIRELESS AND GRAFIK EYE QS WIRELESS DALI</p> <p>Preset Light and Shade Control</p> <ul style="list-style-type: none"> • 4 preset lighting scenes, plus Off, are accessible from the front of the control unit • 12 additional scenes are stored in the control unit. These are accessible via the info screen or via other control stations • Light levels fade smoothly between scenes. Fade time can be set differently for each scene: 0 to 59 seconds, or 1 to 60 minutes. Fade time from Off is capped at 5 seconds • Each shade column can be programmed to operate one shade or multiple shades (a group of shades)
	<ul style="list-style-type: none"> • Energy saving and environmentally friendly • Easy to design and integrate (the integral bus supply for DALI compliant lighting is used for direct control of digital addressable ballasts) • Flexible and expandable 	<p>Scene and Shade Buttons</p> <ul style="list-style-type: none"> • Reduce lighting energy use with built-in timeclock, dimming and occupancy and daylight sensing • Integrates with 3rd party devices for control of AV, HVAC and other building management systems • Connects directly to Sivoia® QS blinds, occupancy and dayling sensors, wallstations and DALI compliant lighting • Easily reconfigure to meet the changing needs of a space, control 3 to 16 zones of light and recall up to 16 scenes • Add multiple components to grow the capabilities of the system • Add Quantum® for total light management of an entire building • Build-in RF capability to connect to Lutron RF sensors, remotes controls and shades • Large, rounded buttons are easy to use. • Backlit buttons with optional engraving make it easy to find and to operate the control unit in low light conditions • Optional button engraving is angled up to the eye for easy reading • Predefined label stickers are included for field labeling
		<p>Zone Control</p> <ul style="list-style-type: none"> • Each zone has a dedicated raise and lower button to adjust the zone • Each zone has a dedicated 7 LED bar graph for level status. Light % and energy saved % is displayed on the info screen • All zone information has blue backlit LEDs. Backlight is programmable to Off <p>Info Screen</p> <ul style="list-style-type: none"> • Screen is viewable from all angles • Programmable zone labels • Programmable scene labels • Status of real-time zone percentage and energy savings • Programmable timeclock schedules

GRAFIK Eye QS Wireless – Triac

GRAFIK Eye QS Wireless DALI

See page 43 for detailed System/Wiring Diagrams.



* The GRAFIK EYE QS is also available as non wireless please ask our customer services for details

Specifications/Dimensions

Part Number

Astronomic Timeclock

- Integral to all units
- 7 daily schedules available
- Holiday schedule is programmable by date up to one year in advance
- 25 events per day available
- Astronomic times are programmable by integral city database or by entering latitude and longitude. Times automatically adjust throughout the year based on location
- Automatically adjusts for Daylight Saving Time, adjusted for the new dates

System Communications and Capacities

- Low-voltage type PELV (Class 2:USA) wiring connects control units, wallstations, motorised shades, and control interfaces
- A QS system can have up to 100 devices and 100 zones
- A QS system can have up to 30 wireless devices
- Class 1/Class 2 wiring connects ballast to control unit

Infrared

- Infrared (IR) receiver allows infrared transmitters to select 8 scenes, raise/lower lighting zones, or raise/lower shades
- Transmitter buttons imitate buttons on faceplate
- 15m (50ft) line of sight range
- Terminal block infrared input for direct contact with external IR connection
- IR can be disabled via programming
- Works with Lutron GRX-IT and GRX-8IT infrared remote controllers

Input power

- 230 V \sim 50/60Hz

Key Design Features

- RF meets IEC 801-2
- Lightning strike protection meets ANSI/IEEE standard 62.41-1980. Can withstand voltage surges of up to 6000 V \sim and current surges of up to 3000 A
- Tested to withstand 16 kV electrostatic discharge without damage or memory loss
- RTISS™-equipped: Compensates in real time for incoming line voltage variations (no visible flicker with +/- 2% change in RMS voltage per cycle, and +/-2% Hz change in frequency per second)
- Power failure memory automatically restores lighting to the scene selected prior to power interruption, and stores timeclock and scene programming
- Faceplate is hinged at the top and bottom, and stays open at 180° for ease of access

Environment

- 0-40°C, (32-104°F)
- Relative humidity less than 90% non-condensing

Standards

- CE
- Certified for IEC/EN compliance
- EN/IEC 60669-2-1
- EN 50428
- VDE
- New Development – KNX ready

Lighting sources/load types

Controls the following lighting sources with a smooth, continuous square law dimming curve or on a full conduction non-dim basis:

- Incandescent
- Magnetic low-voltage transformer
- Neon and cold cathode
- Non-dim (Incandescent, magnetic low-voltage, or neon/cold cathode)

Controls the following lighting sources with a smooth, continuous square law dimming curve through separate power interfaces:

- Electronic low-voltage transformer
- Lutron Tu-Wire® electronic fluorescent dimming ballast
- Up to 64 digital addressable loads

Load Type – Triac Version

	220-240V \sim 50/60Hz
Unit capacity (watts)	2400
Zone capacity (watts)	40 – 500

- All electronic low-voltage (ELV) lighting used with an interface must be rated for reverse phase control dimming. Before installing an ELV light source, verify with the manufacturer that their transformer can be dimmed. When dimming, an ELV interface (such as the NGRX-ELVI-CE-WH) must be used with the control unit
- Not all zones must be connected; however, connected zones must have a minimum load as specified above
- Maximum total lighting load for a magnetic low-voltage (MLV) varies by input voltage:
 - 220-240 V \sim : 500 VA / 400 W

Lighting source DALI version

- DALI addressable devices
- 64 addresses, 16 zones max
- Control DMX: via QSE-DMX-Interface up to 48 channels

GRAFIK EYE QS WIRELESS – TRIAC

3 zones

QSGRK-3PCE-WH
QSGRK-3PCE-TWH
QSGRK-3PCE-1WH
QSGRK-3PCE-1TWH

4 zones

QSGRK-4PCE-WH
QSGRK-4PCE-TWH
QSGRK-4PCE-1WH
QSGRK-4PCE-1TWH

6 zones

QSGRK-6PCE-WH
QSGRK-6PCE-TWH
QSGRK-6PCE-1WH
QSGRK-6PCE-1TWH

GRAFIK EYE QS WIRELESS DALI

6 zones

QSGRK-6D-WH
QSGRK-6D-TWH
QSGRK-6D-1WH
QSGRK-6D-1TWH

8 zones



QSGRK-8D-WH
QSGRK-8D-TWH
QSGRK-8D-1WH
QSGRK-8D-1TWH

16 zones

QSGRK-16D-WH
QSGRK-16D-TWH
QSGRK-16D-1WH
QSGRK-16D-1TWH

Also available as custom (non-standard) please ask our customer service

Load – Controlling Devices

Product	Features	Specifications/Dimensions	Part Number
 <p data-bbox="76 775 344 824">See page 43 for detailed System/Wiring Diagrams.</p>	<p data-bbox="491 479 708 501">POWER BOOSTER (PB)</p> <p data-bbox="491 521 855 584">Increase capacity for loads up to 1820 W of incandescent, halogen magnetic low voltage and neon/cold cathode sources</p>	<p data-bbox="922 479 1023 501">Size in mm</p> <p data-bbox="922 508 1018 530">W: 100mm</p> <p data-bbox="922 533 1018 555">H: 116mm</p> <p data-bbox="922 557 1007 580">D: 48mm</p>	<p data-bbox="1353 479 1485 501">NGRX-PB-CE-WH</p>
 <p data-bbox="76 1305 344 1355">See page 43 for detailed System/Wiring Diagrams.</p>	<p data-bbox="491 1003 879 1043">ELECTRONIC LOW-VOLTAGE INTERFACE (ELVI)</p> <p data-bbox="491 1064 887 1104">Increase capacity for loads up to 1200 W/VA for electronic low-voltage sources</p>	<p data-bbox="922 1003 1023 1025">Size in mm</p> <p data-bbox="922 1032 1018 1055">W: 100mm</p> <p data-bbox="922 1057 1018 1079">H: 116mm</p> <p data-bbox="922 1081 1007 1104">D: 48mm</p>	<p data-bbox="1353 1003 1485 1025">NGRX-ELVI-CE-WH</p>
	<p data-bbox="491 1574 528 1597">TVI</p> <p data-bbox="491 1617 887 1720">Control fluorescent loads of up to a switched load of 10 A, and 0-10 V output rating of 300 mA maximum. The interface sinks current only (max. 150 ballasts). The TVI needs the same phase as for the GRAFIK Eye</p>	<p data-bbox="922 1574 1023 1597">Size in mm</p> <p data-bbox="922 1603 1018 1626">W: 155mm</p> <p data-bbox="922 1628 1018 1650">H: 318mm</p> <p data-bbox="922 1653 1007 1675">D: 84mm</p>	<p data-bbox="1353 1574 1417 1597">GRX-TV1</p>

Product	Features	Specifications/Dimensions	Part Number
---------	----------	---------------------------	-------------

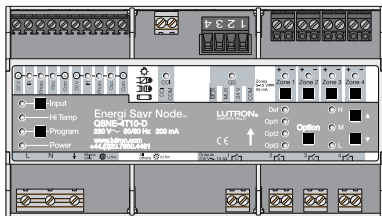

Energi Savr Node for 0-10V

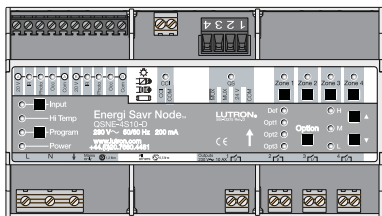

Energi Savr Node for Switching

Energi Savr Node is a simple, programmable solution for controlling light and saving energy in any commercial space. Use Energi Savr Node to connect DALI (digitally addressable lighting interface), 0-10 V or switching ballasts to wired or wireless occupancy sensors, daylight sensors, and controls for total light control.

- Easy to install and maintain
- Expandable
- Versatile
- Energy saving and environmentally friendly

See page 44 for detailed System/Wiring Diagrams.

ENERGI SAVR NODE 0-10 V AND ENERGI SAVR NODE SWITCHING

- Easy and intuitive system programming application designed for the Apple iPhone or iPod touch mobile digital devices¹
- For simple applications, preconfigured modes reduce installation time and eliminate system programming
- Wireless sensors and controls can be easily retrofit with no need for rewiring
- Control a single space, up to an entire floor with one module and add additional Energi Savr Node modules to control multiple floors
- Modules can link with Quantum® for total light management throughout an entire building
- Great for retrofit solutions or new construction – install each module locally – no need to connect to a central panel
- Reduce lighting energy use with dimming, occupancy sensing, and daylight harvesting

Occupancy Sensors

- Use occupancy sensors to automatically turn the lights off in an area a fixed time after it becomes vacant
- Use occupancy sensors to automatically turn the lights on in area when it becomes occupied and to automatically turn the lights off in an area a fixed time after it becomes vacant
- Two occupancy sensors can connect directly to the Energi Savr Node
- Each area's occupied level and unoccupied level can be programmed
- Power Supply Outputs (2)
 - 20-24 V \sim (60 mA) maximum.
 - An auxiliary power supply must be used if the device requires more than 50 mA
- Occupancy sensor must provide a dry contact closure or solid-state output

Accessory Controls

- seeTouch QS wallstations can be configured to control Energi Savr Node relays and 0-10V control zones
- Select one of 16 scenes and off in Energi Savr Node
- Control individual lighting zones
- LED indicator displays scene or zone status

Infrared Receivers

- Use Lutron IR receivers for personal control of individual lighting zones
- Two IR receivers can connect directly to the Energi Savr Node

Daylight Sensors

- Lutron daylight sensors allow daylight harvesting with programmable gain settings
- Two daylight sensors can connect directly to the Energi Savr Node

Communication with GRAFIK Eye QS

- Energi Savr Node zones respond to GRAFIK Eye QS scene buttons when associated with the GRAFIK Eye QS
- Energi Savr Node zones respond to scene commands initiated by the GRAFIK Eye QS astronomic time clock when associated with the GRAFIK Eye QS
- Energi Savr Node operates in afterhours mode when associated with a GRAFIK Eye QS that is in afterhours mode

Communication with QSE-IO

- Zone toggle mode
- Energi Savr Node zones respond to scene commands initiated by the QSE-IO in scene selection mode or occupancy sensor mode

Output Zone Ratings – 4 zones

- Each zone is rated at 10 A for switching. Rated for resistive, inductive, or capacitive loads.
- 0-10 V rated for 50 mA source or sink current per zone (only QSNE-4T10-D)

QS Link Limits

- The QS link can have up to 100 devices and 100 zones
- Each unit counts as 4 zones toward the 100 zone QS link limit

Power

- 220-240 V \sim 50/60 Hz
- Lightning strike protection meets ANSI/IEEE standard 62.31-1980. Can withstand voltage surges of up to 6 000 V \sim and current surges of up to 3 000 A
- Current draw: 200 mA max

Standards

- Lutron Quality Systems registered to ISO 9001.2008
- EN/IEC 60669-2-1 EN 50428

Terminals

- Mains wiring: 0.5 mm² to 6.0 mm²
- 0-10 V Wiring: 0.5 mm² to 2.5 mm²
- Input Wiring: 0.5 mm² to 2.5 mm²
- CCI Wiring: 0.5 mm² to 6.0 mm²
- Zone wiring: 0.5 mm² to 6.0 mm²

Mounting

- Mounts to standard DIN rail (Width = 161.7mm)

Environment

- Ambient Temperature Operating Range (inside mounting panel): 0°C to 40°C
- Calibration point maximum: 65°C
- Relative humidity: less than 90% non-condensing
- For indoor use only

Size in mm

- W: 161.7mm (6.36 in)
- H: 134.6mm (5.3 in)
- D: 60.6mm (2.39 in)

ESN 0-10 V
QSNE-4T10-D

ESN Switching
QSNE-4S10-D

¹ Apple, iPhone, and iPod touch are trademarks of Apple Inc., registered in the U.S. and other countries.

Load – Controlling Devices

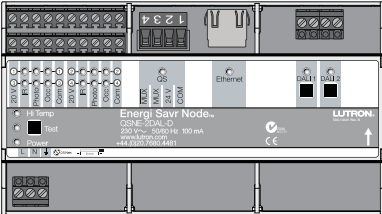

Product	Features	Specifications/Dimensions	Part Number
	<p>ENERGI SAVR NODE FOR DALI</p> <ul style="list-style-type: none"> • Easy and intuitive system programming application designed for the Apple iPhone or iPod touch mobile digital devices¹ • For simple applications, preconfigured modes reduce installation time and eliminate system programming • Automatic ballast replacement eliminates the need for system reprogramming when replacing ballasts (feature available only on DALI version) • Wireless sensors and controls can be easily retrofit with no need for rewiring • Control a single space, up to an entire floor with one module and add additional Energi Savr Node modules to control multiple floors • Modules can link with Quantum® for total light management throughout an entire building • DALI ballast control offers flexibility for reconfiguring frequently changing spaces (feature available only on DALI version) • Great for retrofit solutions or new construction – install each module locally – no need to connect to a central panel • Reduce lighting energy use with dimming, occupancy sensing, and daylight harvesting <p>Occupancy Sensors</p> <ul style="list-style-type: none"> • Use occupancy sensors to automatically turn the lights off in an area a fixed time after it becomes vacant • Use occupancy sensors to automatically turn the lights on in area when it becomes occupied and to automatically turn the lights off in an area a fixed time after it becomes vacant • Four occupancy sensors can connect directly to the Energi Savr Node • Each area's occupied level and unoccupied level can be programmed • Power Supply Outputs (4) <ul style="list-style-type: none"> - 20-24 V\sim (60 mA) maximum. - An auxiliary power supply must be used if the device requires more than 50 mA • Occupancy sensor must provide a dry contact closure or solid-state output <p>Accessory Controls</p> <ul style="list-style-type: none"> • seeTouch QS wallstations can be configured to control Energi Savr Node zones • Select one of 16 scenes and off in Energi Savr Node areas • Control individual lighting zones in Energi Savr Node areas • LED indicator displays the status of programmed lights <p>Infrared Receivers</p> <ul style="list-style-type: none"> • Use Lutron IR receivers for personal control of individual lighting zones • Four IR receivers can connect directly to the Energi Savr Node <p>Daylight Sensors</p> <ul style="list-style-type: none"> • Lutron daylight sensors allow daylight harvesting with programmable gain settings in up to four gain groups per area • Four daylight sensors can connect directly to the Energi Savr Node 	<p>Communication with GRAFIK Eye QS</p> <ul style="list-style-type: none"> • Energi Savr Node zones respond to GRAFIK Eye QS scene buttons in areas associated with the GRAFIK Eye QS • Energi Savr Node zones respond to scene commands initiated by the GRAFIK Eye QS astronomic time clock in areas associated with the GRAFIK Eye QS • Energi Savr Node operates in afterhours mode in areas associated with a GRAFIK Eye QS that is in afterhours mode <p>Communication with QSE-IO</p> <ul style="list-style-type: none"> • Zone toggle mode • Energi Savr Node zones respond to scene commands initiated by the QSE-IO in scene selection mode or occupancy sensor mode <p>DALI Loops – 2 loops</p> <ul style="list-style-type: none"> • Up to 64 DALI compliant loads on each loop can be addressed and grouped into 16 zones • Energi Savr Node supplies 250 mA to power each Loop • DALI Loop wires are polarity insensitive and topology-free <p>QS Link Limits</p> <ul style="list-style-type: none"> • The QS link can have up to 100 devices and 100 zones • Each Energi Savr Node unit counts as one device toward the 100 device limit • Each assigned zone counts toward the 100 zone limit <p>Power</p> <ul style="list-style-type: none"> • 220-240 V\sim 50/60 Hz, max current draw 100 mA • Lightning strike protection meets ANSI/IEEE standard 62.31-1980. Can withstand voltage surges of up to 6 000 V\sim and current surges of up to 3 000 A • DALI Bus Output: 18 V 250 mA maximum per loop <p style="text-align: center;">==</p> <p>Standards</p> <ul style="list-style-type: none"> • CE • Lutron Quality Systems registered to ISO 9001:2008 • EN/IEC 60669-2-1 • EN 50428 <p>Terminals</p> <ul style="list-style-type: none"> • Mains wiring: 1.0 - 4.0mm² • DALI Bus Wiring: 1.0 - 4.0mm² • Sensor Wiring: 1.0- 2.5mm² <p>Mounting</p> <ul style="list-style-type: none"> • Mounts to standard DIN rail (Width = 161.7mm) <p>Environment</p> <ul style="list-style-type: none"> • Ambient Temperature Operating Range: 0°C to 40°C • Relative humidity: less than 90% non-condensing • For indoor use only <p>Size in mm</p> <p>W: 161.7mm (6.36 in) H: 89.7mm (5.3 in) D: 60.6mm (2.39 in)</p>	<p>ESN DALI QSNE-2DAL-D</p>

ESN DALI

See page 44 for detailed System/Wiring Diagrams.

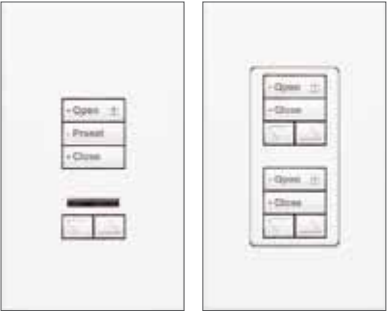
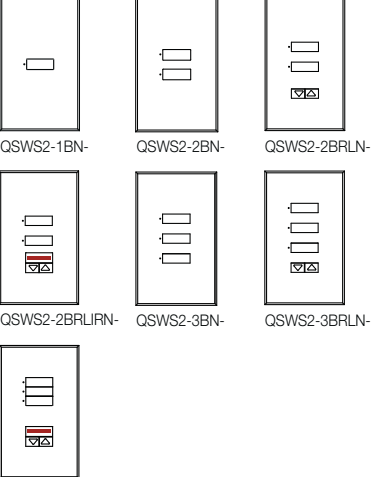

¹ Apple, iPhone, and iPod touch are trademarks of Apple Inc., registered in the U.S. and other countries.

Keypads

Product	Features	Specifications/Dimensions	Part Number
	<p>SEETOUGH KEYPADS</p> <ul style="list-style-type: none"> • Easy to see backlit buttons • Easy to read engraved buttons • Matching buttons and faceplates (matt and gloss finishes) • Text angles up for easy viewing from any mounting height • Large buttons • Rounded button design <ul style="list-style-type: none"> • 1-7 buttons in the same control <p>Key Design Features</p> <ul style="list-style-type: none"> • Field-changeable button and faceplate assemblies make for easy customisation • Front-located buttons allow change of function without removing the unit from the wall • Meets IEC 801-2. Tested to withstand 15kV electro-static discharge without damage or memory loss • Has faceplate that snaps on with no visible means of attachment • Available as an "insert" style control for multi-gangung • Use Button Replacement Kits to change colour, button configuration, engraving • Button Replacement Kits may also be used to convert between non-insert and insert configurations <p>Controls</p> <ul style="list-style-type: none"> • Order Insert (I) models for multigang installations. Non-Insert (N) models cannot be multiganged <p>Installation</p> <ul style="list-style-type: none"> • Use Button Replacement Kits (SR-) to change colour, button configuration, or engraving. Button Replacement Kits may also be used to convert between non-insert (N) and insert (I) configurations 	<p>Power</p> <ul style="list-style-type: none"> • Operating voltage: PELV, 12-35VDC <p>System Communications and Capacity</p> <ul style="list-style-type: none"> • Low-voltage Class 2 (PELV) wiring connects Wallstations to Processor Panel • Use 100 device qs link limit <p>Terminals</p> <ul style="list-style-type: none"> • Capacity: Accept up to two 1.0mm² (#18 AWG) typical <p>Environment</p> <ul style="list-style-type: none"> • 0-40°C, (32-104°F). Relative humidity less than 90% non-condensing <p>Mounting</p> <ul style="list-style-type: none"> • Requires Lutron-supplied backbox <p>Size in mm (Backbox)</p> <p>W: 55mm (2.17 in) H: 95mm (3.74 in) D: 70mm (2.75 in)</p>	<p>Non-insert</p> <p>QSW2-1BN-XX QSW2-2BN-XX QSW2-2BRLN-XX QSW2-3BN-XX QSW2-3BRLN-XX QSW2-5BN-XX QSW2-5BRLN-XX QSW2-7BN-XX QSW2-1RLDN-XX QSW2-2RLDN-XX QSW2-3BDN-XX</p> <p>Insert</p> <p>QSW2-1BI-XX QSW2-2BI-XX QSW2-2BRLI-XX QSW2-3BI-XX QSW2-3BRLI-XX QSW2-5BI-XX QSW2-5BRLI-XX QSW2-7BI-XX QSW2-1RLDI-XX QSW2-2RLDI-XX QSW2-3BDI-XX</p> <p>Also available as custom (non-standard) please ask our customer service</p>
<p>Non-Insert</p>  <p>QSW2-1BN- QSW2-2BN- QSW2-2BRLN- QSW2-2BRLIRN- QSW2-3BN- QSW2-3BRLN- QSW2-3BRLIRN-</p>			
<p>Insert</p>  <p>QSW2-5BI- QSW2-5BRLI- QSW2-5BRLIRI- QSW2-7BI- QSW2-1RLDI- QSW2-2RLDI- QSW2-3BDI-</p>			

These keypads are available as both insert or non insert options.

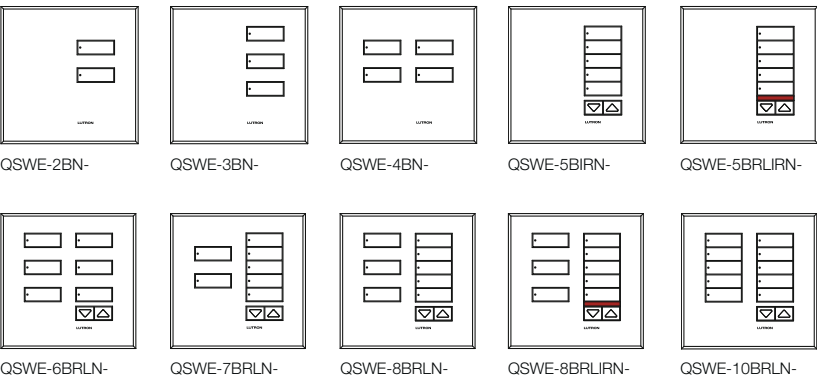
Keypads

Product	Features	Specifications/Dimensions	Part Number
	<p>INTERNATIONAL SEETOUCH KEYPADS</p> <p>Key Design Features</p> <ul style="list-style-type: none"> Field-changeable button and faceplate assemblies allow easy customisation Meets IEC 801-2. Tested to withstand 15 kV electro-static discharge without damage or memory loss Faceplate snaps on with no visible means of attachment Available as an "insert" style control for multi-gangung Use Faceplate Replacement Kits to change colour, button configuration, or engraving Faceplate Replacement Kits may also be used to convert between non-insert and insert configurations 	<p>Power Input (Control Link Terminal 2)</p> <ul style="list-style-type: none"> Low-voltage type PELV. Operating voltage: 24 V_~ <p>System Communications and Capacity</p> <ul style="list-style-type: none"> Low-voltage type PELV wiring connects Wallstations to other devices on the QS Link A QS system can have up to 100 devices and 100 zones; International seeTouch QS counts as one device and no zones on the QS Link <p>Terminals</p> <ul style="list-style-type: none"> Accept up to two 1.0mm² (18 AWG) typical <p>Environment</p> <ul style="list-style-type: none"> 0-40°C (32-104°F). Relative humidity less than 90% non-condensing <p>Mounting</p> <ul style="list-style-type: none"> Typical backbox dimensions: 75mm (3 in) wide x 75mm (3 in) tall x 35mm (1.4 in) deep Round backbox 68mm (UK) <p>Size in mm</p> <p>W: 75mm (3 in) H: 75mm (3 in) D: 35mm (1.4 in)</p>	<p>2 Button</p> <p>QSWE-2BN-xx-xx QSWE-2BI-xx-xx</p> <p>3 Button</p> <p>QSWE-3BN-xx-xx QSWE-3BI-xx-xx</p> <p>4 Button</p> <p>QSWE-4BN-xx-xx QSWE-4BI-xx-xx</p> <p>5 Button with Raise/Lower</p> <p>QSWE-5BRLN-xx-xx QSWE-5BRLI-xx-xx</p> <p>5 Button with Infrared & Raise/Lower</p> <p>QSWE-5BRLRN-xx-xx QSWE-5BRLRIRI-xx-xx</p> <p>Dual Wallstation with 3-Button and 3-Button with Raise/Lower</p> <p>QSWE-6BRLN-xx-xx QSWE-6BRLI-xx-xx</p> <p>7-Button Wallstation with Raise/Lower</p> <p>QSWE-7BRLN-xx-xx QSWE-7BRLI-xx-xx</p> <p>8-Button Wallstation with Raise/Lower</p> <p>QSWE-8BRLN-xx-xx QSWE-8BRLI-xx-xx</p> <p>8-Button Wallstation with Infrared Receiver and Raise/Lower</p> <p>QSWE-8BRLRN-xx-xx QSWE-8BRLRIRI-xx-xx</p> <p>10-Button Wallstation with Raise/Lower</p> <p>QSWE-10BRLN-xx-xx QSWE-10BRLI-xx-xx</p>
<p><i>Frameless</i></p> 			
<p><i>Framed</i></p> 			

Product	Features	Specifications/Dimensions	Part Number
	<p>INFRARED CEILING MOUNT SENSOR</p> <ul style="list-style-type: none"> • Intelligent, continually adapting passive infrared (PIR) sensor • Passive infrared sensing • Reliable motion detection with high error immunity • Snap-locks to ceiling-mounted cover plate • Non-Volatile Memory: settings saved in protected memory are not lost during power outages • 42 to 140m² (450 to 1500sq.ft.) coverage when mounted on an 2.4 - 3.7m (8 - 12ft) ceiling • Affords choice of turning lights off or dimming to a preset level in the unoccupied state when integrated with a Lutron system 	<p>Timer Adjustment</p> <ul style="list-style-type: none"> • Automatic mode: Continually adapting sensor automatically adjusts settings to the space • Manual mode: 8 to 30 minutes • Test mode: 8 seconds <p>LED Lamp</p> <ul style="list-style-type: none"> • Red: infrared motion detected <p>Housing</p> <ul style="list-style-type: none"> • Rugged, high-impact, injection-molded plastic • Colour-coded leads 15cm (6in) <p>Power</p> <ul style="list-style-type: none"> • Operating voltage: 20 - 24 V_~ PELV low-voltage • Operating current: 33 mA nominal • Control output: 20 - 24 V_~ active high logic control signal with short-circuit protection, open collector when unoccupied • CE listed <p>Operating Environment</p> <ul style="list-style-type: none"> • Temperature: 0 to 40°C (32 to 104°F) • Relative humidity: less than 95%, non-condensing • For indoor use only <p>Size in mm</p> <p>W: 114mm (4.5 in) H: 114mm (4.5 in) D: 38mm (1.4 in)</p>	<p>LOS-CIR-450-WH LOS-CIR-1500-WH</p>

 <p>See page 45/46 for detailed System/Wiring Diagrams.</p>	<p>DAYLIGHT SENSOR WITH INFRARED RECEIVER</p> <ul style="list-style-type: none"> • Photopic response matches human eye • Mounts easily on any ceiling tile or fixture with 10mm (3/8 in) diameter hole • Threaded mounting stud (may be shortened for applications with limited fixture height) • Calibrated for daylight sensitivity through the Lighting Control System to which it is attached • Receives IR signals and transfers them to a digital ballast, control module, or sensor interface • The Infrared Receiver receives IR programming signals from up to 2.5m (8.2ft) away • Constructed of flame retardant material • Meets IEC 801-2. Tested to withstand 15 kV electrostatic discharge without damage • LED indicates programming mode 	<p>Standards</p> <ul style="list-style-type: none"> • Designed for PELV operation only. Voltages do not exceed 35 V_~ • Designed to give a linear response to changes in viewed light level • For use with Lutron products only <p>Environment</p> <ul style="list-style-type: none"> • Temperature: 0-45°C (32-113°F) • Relative humidity: less than 90% non-condensing <p>Power</p> <ul style="list-style-type: none"> • Operating Voltage: Low-voltage PELV, 20 V_~ • Analog Signal: 0-2 mA • IR Output: 0-20 V_~ <p>Dimensions</p> <ul style="list-style-type: none"> • Sensor lead length = 100mm (4 in) minimum beyond threaded stud • Total wire length from sensor to device must not exceed 30m (100ft) • Threaded Stud Diameter = 9.5mm (3/8in) maximum • Use 3/8-16 nut (provided) for mounting <p>Size in mm</p> <p>W: 30mm (1.18 in) H: 30mm (1.18 in) D: 17mm (0.69 in) front unit, 32mm (1.25 in) threaded stud</p>	<p>EC-DIR-WH</p>
--	--	---	------------------

Product	Features	Specifications/Dimensions	Part Number
 <p data-bbox="76 815 363 864">See page 45/46 for detailed System/Wiring Diagrams.</p>	<p data-bbox="491 479 807 524">DUAL TECHNOLOGY CEILING MOUNT SENSOR</p> <ul data-bbox="491 551 887 931" style="list-style-type: none"> • Intelligent, continually adapting passive infrared (PIR) sensor • Passive infrared sensing • Reliable motion detection with high error immunity • Snap-locks to ceiling-mounted cover plate • Non-Volatile Memory: settings saved in protected memory are not lost during power outages • 42 to 140m² (450 to 1500sq.ft.) coverage when mounted on an 2.4 - 3.7m (8 - 12ft) ceiling • Affords choice of turning lights off or dimming to a preset level in the unoccupied state when integrated with a Lutron system • 46 to 186m² (500 to 2000sq.ft.) coverage when mounted on an 2.4 to 3.7m (8 - 12ft) ceiling; 180° and 360° field of view 	<p data-bbox="927 479 1086 501">Timer Adjustment</p> <ul data-bbox="927 506 1318 595" style="list-style-type: none"> • Automatic mode: Continually adapting sensor automatically adjusts settings to the space • Manual mode: 8 to 30 minutes • Test mode: 8 seconds <p data-bbox="927 629 1023 651">LED Lamp</p> <ul data-bbox="927 656 1222 696" style="list-style-type: none"> • Red: infrared motion detected • Green: ultrasonic motion detected <p data-bbox="927 719 999 741">Housing</p> <ul data-bbox="927 745 1318 786" style="list-style-type: none"> • Rugged, high-impact, injection-molded plastic • Colour-coded leads 15cm (6in) <p data-bbox="927 819 1015 842">Standards</p> <ul data-bbox="927 846 975 869" style="list-style-type: none"> • CE <p data-bbox="927 898 983 920">Power</p> <ul data-bbox="927 925 1318 1048" style="list-style-type: none"> • Operating voltage: 20 - 24 V_~ PELV low-voltage • Operating current: 33 mA nominal • Control output: 20 - 24 V_~ active high logic control signal with short-circuit protection, open collector when unoccupied <p data-bbox="927 1070 1094 1093">Adaptive Functions</p> <ul data-bbox="927 1097 1318 1335" style="list-style-type: none"> • Installation: 60 minutes • Learning: 4 weeks for response to error conditions, air current adaptation, and timer optimisation • Post-learning occupancy periods – 24 hour circadian occupancy periods learned – Weekly occupancy periods learned • Adjustments in post-learning period – Generally occupied periods (threshold = high-sensitivity mode) – Generally unoccupied periods (threshold = miser mode) <p data-bbox="927 1357 1206 1379">Contact Rating (R Models only)</p> <ul data-bbox="927 1384 1318 1406" style="list-style-type: none"> • SPDT 500 mA rated at 24 V_~ isolated relay) <p data-bbox="927 1424 1158 1447">Photo Cell (R Models only)</p> <ul data-bbox="927 1451 1302 1514" style="list-style-type: none"> • Prevents light from turning on when there is sufficient natural light • Sensitivity: 0 - 1000 LUX adjustable <p data-bbox="927 1536 1134 1559">Operating Environment</p> <ul data-bbox="927 1563 1254 1648" style="list-style-type: none"> • Temperature: 0 to 40°C (32 to 104°F) • Relative humidity: less than 95%, non-condensing • For indoor use only <p data-bbox="927 1671 1023 1693">Size in mm</p> <p data-bbox="927 1697 1086 1720">W: 114mm (4.5 in)</p> <p data-bbox="927 1724 1086 1747">H: 114mm (4.5 in)</p> <p data-bbox="927 1751 1078 1774">D: 38mm (1.4 in)</p>	<p data-bbox="1362 479 1509 607">LOS-CDT-500-WH LOS-CDT-500R-WH LOS-CDT-1000-WH LOS-CDT-1000R-WH LOS-CDT-2000-WH LOS-CDT-2000R-WH</p>

Product**Features****Specifications/Dimensions****Part Number**

See page 45/46 for detailed System/Wiring Diagrams.

**RADIO POWR SAVR™
WIRELESS OCCUPANCY AND
VACANCY SENSOR**

- Wireless occupancy sensor has 3 settings available: Auto-On/Auto-Off, Auto-On Low-Light/Auto-Off, and Manual-On/Auto-Off options
- Auto-On Low-Light feature will only turn lights on automatically if there is less than approximately 1 fc (10 lux) of ambient light
- 10-year battery life design
- Passive infrared motion detection with exclusive Lutron XCT™ Technology for fine motion detection
- 360° coverage ranges from 30m² (324ft²) to 62m² (676ft²) for superior fine motion detection
- Multiple ceiling-mount methods available for different ceiling materials
- RoHS compliant
- Simple and intuitive adjustments available for Timeout, Auto-On, and Sensitivity settings
- Front accessible test buttons make setup easy
- Lens illuminates during test mode to verify ideal locations
- Up to 3 sensors can be added with each RF dimming or switching device for extended coverage
- Each sensor may be added to up to 10 compatible RF dimming and switching devices for spaces with multiple zones of lighting
- The sensor should be mounted within 10m (33ft) of the associated dimming and switching receiving devices

Sensor Coverage Test

- Front accessible test button
- Lens illuminates orange in response to motion during test mode and is visible from 9m (30ft)

Wireless Communication Test

- Front accessible test button
- Turn loads on and off

Timeout Options

- 5 minutes
- 15 minutes*
- 30 minutes

Auto-On Options (Occupancy Version Only)

- “Always”* – Sensor turns lights ON and OFF automatically
- “Low light” – Sensor turns lights ON automatically only in low ambient light conditions. Sensor turns lights OFF automatically
- “Disable” – Lights must be turned ON manually from dimming or switching device. Sensor turns lights OFF automatically

Standards

- CE
- EN 50428

Power

- Operating voltage: 3 V_~
- Operating current: 20 μA nominal
- Requires one CR 123 lithium battery
- 10-year battery life design
- Non-volatile memory (saved changes are stored during power loss)

Environment

- Temperature: 0°C - 40°C (32°F - 104 °F)
- For indoor use only

Size in mm

- W: 102mm (4 in)
- H: 102mm (4 in)
- D: 33mm (1.3 in) front panel,
50mm (2 in) front and back combined

* default settings

LRF3-OCRB-P-WH

Product	Features	Specifications/Dimensions	Part Number
 <p data-bbox="76 860 363 904">See page 45/46 for detailed System/Wiring Diagrams.</p>	<p data-bbox="491 479 820 524">RADIO POWR SAVR™ WIRELESS DAYLIGHT SENSOR</p> <ul data-bbox="491 551 893 999" style="list-style-type: none"> • Daylight compensation through Lutron's reliable open loop control • Light range 0–107,000 Lux (0-10,000 fc) • Designed to give a linear response to changes in viewed light level • Wireless daylight sensor has simple calibration • One sensor can be associated to up to 10 compatible RF dimming and switching devices allowing for switching, stepped dimming, and continuous dimming of multiple zones • Intuitive test mode provides instant system verification • 10-year battery life • Multiple ceiling mount methods available for different ceiling materials • Works seamlessly with Radio Powr Savr™ Occupancy Sensors and Pico™ wireless controls • Front accessible test buttons make setup easy • RoHS compliant • Capable of override for a maximum of 2 hours 	<p data-bbox="922 479 1107 501">Power/Performance</p> <ul data-bbox="922 506 1276 636" style="list-style-type: none"> • Operating voltage: 3 V_~ • Operating current: 7 μA • Requires one CR 2450 lithium battery • 10-year battery life • Non-volatile memory (settings are stored during power loss) <p data-bbox="922 658 986 680">Range</p> <ul data-bbox="922 685 1311 748" style="list-style-type: none"> • Local load controls must be located within 18m (60ft) line of sight, or 10m (33ft) through walls, of a daylight sensor <p data-bbox="922 770 1018 792">Standards</p> <ul data-bbox="922 797 979 819" style="list-style-type: none"> • CE <p data-bbox="922 842 1043 864">Environment</p> <ul data-bbox="922 869 1254 909" style="list-style-type: none"> • Temperature: 0°C - 40°C (32°F - 104°F) • For indoor use only <p data-bbox="922 931 1027 954">Size in mm</p> <p data-bbox="922 958 1075 981">W: 41mm (1.6 in)</p> <p data-bbox="922 983 1075 1005">H: 41mm (1.6 in)</p> <p data-bbox="922 1008 1075 1030">D: 17mm (0.7 in)</p>	<p data-bbox="1353 479 1474 501">LRF3-DCRB-WH</p>

Product**Features****Specifications/Dimensions****Part Number**

See page 45/46 for detailed System/Wiring Diagrams.

QS SENSOR MODULE

- Uses Clear Connect™ RF Technology for communication with Radio Powr Savr™ occupancy sensors, Radio Powr Savr daylight sensors, and Pico™ wireless controllers
- QSM connects to four Lutron wired sensors or controls occupancy sensors, daylight sensors
- Powered by the QS communication link no line voltage connections are required
- Compatible with Energi Savr Node. – Energi Savr Node for 0-10 V (model QSN-4T16-S). – Softswitch Energi Savr Node (model QSN-4S16-S). – Allows Lutron wired or Radio Powr Savr wireless occupancy sensors and daylight sensors linked to QSM to control the Energi Savr Node
- Compatible with GRAFIK Eye QS.
 - GRAFIK Eye QS models starting with QSGR-, QSGRJ-, or QSGRK
 - Allows Lutron wired or Radio Powr Savr wireless occupancy sensors and daylight sensors linked to QSM to control the GRAFIK Eye QS
 - Contact Lutron for compatibility with Pico wireless controllers
- Compatible with Sivoia QS shades and draperies
 - Allows Pico wireless controllers to control Sivoia QS shades and draperies
- Contact Lutron for compatibility details with Quantum

Wireless Communications

- RF Range: 18m (60ft) line of sight, or 9m (30ft) through walls
- Install QSM on the bottom of the ceiling, visible from inside the space, to guarantee wireless range
- **Lutron Radio Powr Savr™** – Occupancy sensor – Vacancy sensor – Daylight sensor
- **Lutron Pico™** wireless controllers – A single QSM can accommodate 10 Lutron Pico wireless controllers being programmed to 10 different shade/light groups
- For number of wireless sensors refer to the Energi Savr Node™, GRAFIK Eye® QS, Quantum®, or Sivoia® QS shades and draperies Specification Submittals

Wired Inputs

- There are 4 universal wired inputs. Each input can accept one of the following
- Lutron occupancy sensors
- Lutron daylight sensors
- Maximum wiring distance = 40m (150ft)

Power

- 24 V_~
- Current draw: max load 400mA (with max. wired sensors)
no load 100mA (without wired sensors)
- 10-year power failure memory: restores settings and programming after power interruption

Terminals

- Sensor wiring: 0.5mm² to 2.0mm²
- QS Link wiring: 0.5mm² to 2.0mm²

QS Link Limits

- The QS Link can have up to 100 devices.
- Each QS Sensor Module counts as 1 device towards the 100 device limit

Standards

- FCC Approved. Complies with the limits for a Class B digital device, pursuant to Part 15 of the FCC Rules (QSM2-4W-C only)
- Lutron® Quality Systems registered to ISO 9001:2000
- CE Compliant
- UL Listed

Environment

- Ambient Temperature Operating Range: 0°C to 40°C (32°F to 104°F)
- Relative humidity: less than 90% non-condensing
- For indoor use only

Size in mm

W: 102.67mm (4.042 in)
H: 102.67mm (4.042 in)
D: 29.83mm (1.174 in)
Ceiling thickness range Min 7.62mm (0.30 in) to Max 30.48mm (1.200 in)

QSM3-4W-C

Interfaces and Programming Interfaces

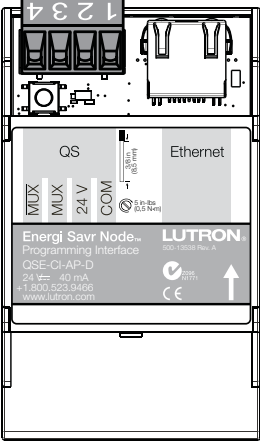
Product	Features	Specifications/Dimensions	Part Number
	<p>ENERGI SAVR NODE PROGRAMMING INTERFACE</p> <ul style="list-style-type: none"> • Program all Energi Savr Node modules connected to the same QS link as the Energi Savr Node Programming Interface using the Energi Savr Node app on the Apple iPhone or iPod touch mobile digital devices • A system is defined as all devices connected on a single QS link. For installations with multiple QS links, one Energi Savr Node Programming Interface is required for every QS link • Powered by the QS link, line voltage not required • Install using one of the three following methods: <ol style="list-style-type: none"> 1. DIN rail 2. Surface mount 3. Junction box <p>Requirements</p> <ul style="list-style-type: none"> • The Energi Savr Node Programming Interface is powered by the QS link, and consumes 2 power draw units • QS Communication Link Wire (NEC® Class 2/ PELV) • Connect a WiFi router to the Energi Savr Node Programming Interface for Apple iPhone or iPod touch programming <p>Programming Requirements</p> <ul style="list-style-type: none"> • An Apple iPod touch or iPhone mobile digital device with the Energi Savr Node app is required for programming Energi Savr Node units • The Energi Savr Node app for Apple iPod touch, iPad or iPhone is used to program the Energi Savr Node unit in installations requiring an ESN Programming Interface for commissioning. The Energi Savr Node app is available from the iTunes Store online marketplace • The Apple iPod touch, iPad or iPhone communicates with the Energi Savr Node unit via a WiFi router (not included) 	<p>Power</p> <ul style="list-style-type: none"> • Low-voltage PELV (Class 2:USA) • Operating voltage: 24 V 40 mA • Uses two (2) power draw units on the QS link <p>Standards</p> <ul style="list-style-type: none"> • CE Certified • Lutron® Quality Systems registered to ISO 9001.2000 <p>Environment</p> <ul style="list-style-type: none"> • Ambient Temperature Operating Range: 0°C to 40°C (32°F to 104°F) • Relative humidity: less than 90% non-condensing • For indoor use only <p>Terminals</p> <ul style="list-style-type: none"> • Ethernet port • QS Link Wiring: 0.5mm² – 4.0mm² <p>Mounting</p> <ul style="list-style-type: none"> • DIN rail • Surface mount • Junction box <p>Ethernet Connection</p> <ul style="list-style-type: none"> • Standard CAT5 (or better) cable connects the QSE-CI-AP-D interface to a wireless router • Supports MDI/MDIX auto-crossover (no crossover cable needed) • Total cable length must be 91m (300ft) or less • Ethernet network and cable provided by others <p>Size in mm</p> <p>W: 53mm (2.1 in) H: 88mm (3.5 in)</p>	<p>QSE-CI-AP-D</p>

See page 47 for detailed System/Wiring Diagrams.

Product

Features

Specifications/Dimensions

Part Number



See page 47 for detailed System/Wiring Diagrams.

QSE-IO

- Integrates a QS control system with equipment that has contact-closure I/O, including:
 - Motion and occupant sensors
 - Timeclocks and push buttons
 - Motorised projection screens, skylights, window shades, and movable walls
 - AV equipment
 - Security systems
- May be programmed to control or be controlled by any combination of GRAFIK Eye QS control units or control any combination of Sivoia QS window treatments on the QS link

Inputs/Outputs

- Provides five inputs and five dry contact closure outputs
- Provides both normally open (NO) and normally closed (NC) contacts
- Using the inputs, contact closures in other equipment can operate control units to:
 - Select scenes
 - Adjust scenes to reflect status of movable walls
 - Toggle any combination of zones in the system between Off and a configurable preset value
 - Turn lights on or off and/or move shades based on room occupancy
 - Perform special functions such as sequencing, panic, control lockout, or time clock disable
- Using the outputs, scene and/or zone changes in control units can:
 - Trigger outputs to control other equipment
 - Provide status feedback to other equipment
- Using the inputs, contact closures in other equipment can operate Sivoia QS window treatments to:
 - Open or close
 - Raise, lower, or stop
 - Select one of three adjustable presets
- Using the outputs, key presses on QS window treatment keypads or GRAFIK Eye QS window treatment buttons can:
 - Trigger outputs to other motorised window treatment equipment

Operating Modes

- Scene selection
- Zone toggle
- Special functions
- Partitioning
- Occupant sensor
- Shade input
- Shade output

Five Input Terminals

- Accept maintained inputs and momentary inputs with 40m/sec minimum pulse times
- Off-state leakage current must be less than 100 μ A
- Open circuit voltage: 24 V \sim maximum
- Inputs must be dry contact closure, solid state, open collector, or active-low (NPN)/active high (PNP) output
 - Open collector NPN or active-low on-state voltage must be less than 2 V \sim and sink 3.0 mA
 - Open collector PNP or active-high on-state voltage must be greater than 12 V \sim and source 3.0 mA

Five Output Terminals

- Provide selectable maintained or momentary (1/4-second) outputs (PELV/Class 2:USA rated only)
- The QSE-IO is not rated to control unclamped, inductive loads. Inductive loads include, but are not limited to, relays, solenoids, and motors. To control these types of equipment, a fly back diode must be used (DC voltages only). See below diagram on the left
- Output relays are non-latching (if relays are closed and power is lost, relays will open)

Status LEDs

Five Status LEDs light when associated output is active (on)

System Communications and Capacity

- Low-voltage type PELV (Class 2: USA) wiring connects the QSE-IO Interface to control units and other components
- QSE-IO counts as 1 device toward system maximum of 100 devices
- 3 wallstations maximum can be powered from one GRAFIK Eye QS control unit without external 24 V \sim power supply; or 1 wallstation powered by a QSE-IO (QSE-IO counts as two wall stations in this use)

Power

- Low-voltage PELV (Class 2:USA). Operating voltage: 12 - 24 V \sim , 200 mA
- Provides 2-way interface between preset lighting controls or window treatments and dry contact closure devices
- Provides 5 inputs and 5 outputs. Outputs can control other manufacturers' equipment

Environment

- 0-40°C, (32-104°F). Relative humidity less than 90% non-condensing

Size in mm

W: 108.2mm (4.26 in)
 H: 133.6mm (5.26 in)
 D: 26.9mm (1.06 in)
 Height to mounting holes: 63.5mm (2.5 in)

QSE-IO

QS Data Link (to control units, window treatments, and wallstations)

- 4: MUX
- 3: MUX
- 2: 24 V \sim
- 1: Common

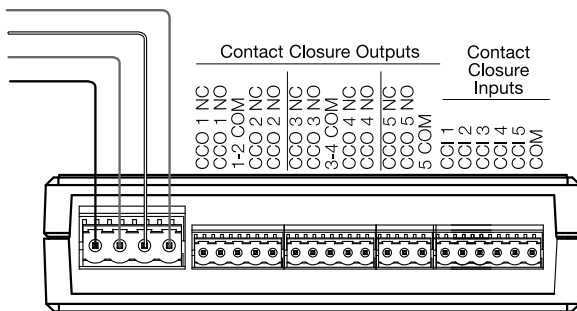

CCI and CCO terminals each hold one #28 - 0.08 - 1.5 mm² (16 AWG) wire

Interfaces and Programming Interfaces

Product	Features	Specifications/Dimensions	Part Number
	<p>QSE-CI-DMX CONTROL INTERFACE</p> <ul style="list-style-type: none"> • Map any zone on a GRAFIK Eye QS Wireless control unit to any single DMX512 channel • Map any zone on a GRAFIK Eye QS Wireless control unit simultaneously to three DMX512 channels for RGB/CMY colour-control • Integral RGB/CMY lookup table that maps GRAFIK Eye QS zone intensities to RGB/CMY values • RGB/CMY table can be customised by using the Lutron QS colour configuration tool (PC application available on the CD packaged with the QSE-CI-DMX, and on www.lutron.com/qs) <p>Requirements</p> <p>The QSE-CI-DMX requires the following:</p> <ul style="list-style-type: none"> • At least one GRAFIK Eye QS Wireless control unit connected to the QSE-CI-DMX through the QS communication link • QS link power supply; either: <ul style="list-style-type: none"> – GRAFIK Eye QS Wireless, as long as the GRAFIK Eye QS Wireless is not powering any other QS link devices drawing a total of two (2) or more power draw units – QS link power supply, such as the QSPS-P1-1-50 • DMX512 link terminators at both ends of the DMX512 link (available from lutron, part number LT-1) • QS Communication Link Wire (PELV, Class 2: USA) <ul style="list-style-type: none"> – Two 1.0mm² (18 AWG) conductors for control power – One twisted, shielded pair of 1.0mm² (22 AWG) for data link – Available from Lutron, part number GRX-CBL-346S; check compatibility in your area 	<p>System Capabilities/Limits</p> <p>QS Link System Limits</p> <ul style="list-style-type: none"> • One QSE-CI-DMX per QS link • 100 QS devices per QS link (see below) • 100 zones per QS link (see below) • With Grafik Eye QS DALI QSGRK-16D you can control up to 48 DMX channels <p>QS Link Wiring Limits</p> <ul style="list-style-type: none"> • Total length of link must not exceed 610m (2000ft) • Do not allow PELV (Class 2: USA) wires to contact line/mains wires <p>DMX512 Link Wiring Limits</p> <ul style="list-style-type: none"> • Each terminal can accept up to two 1.0mm² (18 AWG) wires • Link must be 305m (1000 feet) or less • DMX Link must begin and end with link terminators (available from Lutron; part number LT-1) • Three pins on the DMX connector for connecting the QSE-CI-DMX to DMX512-controlled equipment <p>Power</p> <ul style="list-style-type: none"> • Low-voltage PELV (Class 2:USA) • Operating voltage: 24 V_~, 60 mA <p>Environment</p> <ul style="list-style-type: none"> • 0-40°C, (32-104°F). Relative humidity less than 90% non-condensing <p>Size in mm</p> <p>W: 108.2mm (4.26 in) H: 133.6mm (5.26 in) D: 26.9mm (1.06 in) Height to mounting holes: 63.5mm (2.5 in)</p>	<p>QSE-CI-DMX</p>

See page 47 for detailed System/Wiring Diagrams.

Product	Features	Specifications/Dimensions	Part Number
---------	----------	---------------------------	-------------



See page 47 for detailed System/Wiring Diagrams.

QSE-CI-NWK-E CONTROL INTERFACE

- Integrates a GRAFIK Eye QS Lighting & Shade Control System with a touchscreen, PC, or other digital equipment that supports RS232 communication, or TCP/IP communication over Ethernet
- Provides monitoring commands that allow a touchscreen or PC to query GRAFIK Eye QS Control Units to:
 - Determine which scene is selected
 - Read individual zone's intensity
 - Keep track of buttons pressed
- Provides control commands that allow a touchscreen or PC to operate GRAFIK Eye Control Units to:
 - Select or sequence lighting scenes
 - Raise or Lower one or more zones
 - Set Zone Intensity on GRAFIK Eye QS Series Control Units, which allows users to set intensities on zones of light and to raise and to lower an individual shade zone (Sivoia QS™ shades also allow the selection of individual shade zone levels)
 - Report scene changes and/or button presses
- May be programmed to control any combination of GRAFIK Eye QS Series Control Units on the link
- Provides two-way communication to and from QS system
- One (1) QSE-CI-NWK-E per QS system

Uses QS Command Set for Grafik EyeQS

- Monitoring: Scene selection, scene status updates, read zone intensity, read shade level
- Control: Scene selection, scene lockout, sequencing, zone lockout, zone raise/lower, set shade level
- Additional control with GRAFIK Eye QS Series Control Units: Set shade level
- Command set is available online

Functions

- Dip switches are set at factory, all Off
- Only the RS232 or only the Ethernet may be in use at one time

System Communications and Capacity for RS232 Connection

- Low-voltage PELV (Class 2:USA) wiring connects the Control Interface to GRAFIK Eye QS Control Units
- Standard male 9-pin serial connector plugs into RS232 equipment and the QSE-CI-NWK-E
- 15m (50 feet) maximum from QSE-CI-NWK-E Interface to PC or other RS232 source

System Communications and Capacity for Ethernet Connection

- Low-voltage PELV (Class 2:USA) wiring connects the Control Interface to GRAFIK Eye QS Control Units
- Standard CAT5 cable, 100m (328 feet) maximum, connects the QSE-CI-NWK-E interface to a PC or other Ethernet source
- Supports MDI/MDIX auto-crossover (no crossover cable needed)
- Auto-negotiation of 10 or 100 Mbps speed and full- or half-duplex operation

Power

- Low-voltage PELV (Class 2:USA)
- Operating Voltage: 12 - 24 V_~

Environment

- 0-40°C, (32-104°F). Relative humidity less than 90% non-condensing

Size in mm

- W: 108.2mm (4.26 in)
- H: 133.6mm (5.26 in)
- D: 26.9mm (1.06 in)
- Height to mounting holes: 63.5mm (2.5 in)

QSE-CI-NWK-E

Processor and Server

Product	Features	Specifications/Dimensions	Part Number
	<p>LIGHT MANAGEMENT HUB</p> <ul style="list-style-type: none"> Designed to control, manage, and monitor digital addressable ballasts, Lutron power panels, GRAFIK Eye QS, and Sivoia QS shade systems in a building or whole campus Supports both astronomic and time-of-day events to automatically control the lights and shades in the system Simple reconfiguration of a space without rewiring Individually control, monitor, and adjust any light or shade in a space GRAFIK Eye QS control links are topology-free <p>Panel Capabilities</p> <ul style="list-style-type: none"> Lighting management panels communicate via a dedicated Ethernet link Supports up to 2 Quantum processors with total of 2 links each that can be individually configured as: <ul style="list-style-type: none"> Lutron power panels GRAFIK Eye QS Sivoia QS shades 	<p>Power</p> <ul style="list-style-type: none"> Input voltage: 220 - 240 V\sim, normal/emergency feeder 50/60 Hz 10 A. Output: Processor - 24 V\sim 1 A per link <p>Physical Design</p> <ul style="list-style-type: none"> Enclosure: IP-20 protection #16 U.S. gauge steel Weight: 20.4 kg <p>Mounting</p> <ul style="list-style-type: none"> Surface mount only <p>Environment</p> <ul style="list-style-type: none"> For indoor use only 0 - 40 °C Relative humidity less than 90% non-condensing <p>Size in mm</p> <p>W: 400mm (15.75 in) H: 800mm (31.50 in) D: 148mm (5.83 in)</p>	<p>QP2-1P0CSE-230 QP2-2P0CSE-230</p>

See page 48 for detailed System/Wiring Diagrams.

	<p>Q-MANAGER™ SERVER</p> <p>Minimum Hardware Configuration Provided</p> <ul style="list-style-type: none"> Single Intel Xenon or Dual Core CPU with minimum speed of 3.0 GHz 2 GB RAM 80 GB hard drive 2 Ethernet ports <ul style="list-style-type: none"> One (1) 10/100/1000 network interface for communication to Quantum lighting management panels One (1) 10/100/1000 Ethernet network interface for communication to corporate intranet, allowing access from Q-Admin client PC and/or Green Glance client PC Graphics card capable of 1024 x 768 resolution 17 in. monitor with 1024 x 768 resolution 48X CD/DVD-ROM drive 3 USB 2.0 ports Standard keyboard and mouse Standard tower enclosure (contact Lutron for dimensions) Rack mount bracket available; contact for availability and model number 	<p>Minimum Software Provided</p> <ul style="list-style-type: none"> Licensed installation of US English 32-bit Microsoft Windows Server 2003 with Service Pack 2 <p>Installation Requirements</p> <p>Power</p> <ul style="list-style-type: none"> 100 V min, to 220-240 V\sim max. with backup power Server requires at least 4 power receptacles Power should be through an uninterruptable power supply (UPS) rated for at least 1500 VA, not supplied by Lutron <p>Environmental</p> <ul style="list-style-type: none"> Storage temperature: -17 to 48°C Ambient temperature with server turned on: 10 to 35°C; 8 to 80% humidity, non-condensing 	<p>QS-E-CMP-S-0</p>
---	--	---	---------------------

See page 48 for detailed System/Wiring Diagrams.

Product	Control and Monitoring	Reporting and Administration	Part Number
 <p data-bbox="76 853 347 902">See page 48 for detailed System/Wiring Diagrams.</p>	<p data-bbox="491 481 879 548">Q-ADMIN™ SOFTWARE/QUANTUM™ PROCESSOR SOFTWARE: LIGHT CONTROL AND MONITORING</p> <p data-bbox="491 573 644 595">Control of Lights</p> <ul data-bbox="491 600 890 790" style="list-style-type: none"> • Area lights can be monitored for on/off status • All lights in an area can be turned on/off or sent to a specific level • Areas that have been zoned may be sent to a predefined lighting scene, and individual zones may be controlled • Area lighting scenes can be modified in real time, changing the levels that zones go to when a scene is activated <p data-bbox="491 813 595 835">Occupancy</p> <p data-bbox="491 840 884 902">Occupancy allows the building manager (or security guard) to monitor occupancy status and make occupancy setting changes as follows:</p> <ul data-bbox="491 907 874 1075" style="list-style-type: none"> • Area occupancy can be monitored • Area occupancy can be disabled to override occupancy control or in case of occupant sensor problems • Area occupancy settings (including the level the lights turn on to when area is occupied, and off to when area is unoccupied) can be changed in real time <p data-bbox="491 1097 595 1120">Daylighting</p> <ul data-bbox="491 1124 890 1227" style="list-style-type: none"> • Daylighting can be enabled/disabled for each daylight area • Daylight target levels can be changed for each daylight area. This is particularly useful when new departments move into a space <p data-bbox="515 1249 639 1272">IntelliDemand</p> <p data-bbox="515 1276 874 1379">IntelliDemand allows the building manager to monitor whole-building lighting power usage and apply a load shed reduction to selected areas, thereby reducing a building's power usage</p> <p data-bbox="515 1402 619 1424">Scheduling</p> <p data-bbox="515 1429 858 1491">Schedule time of day and astronomic timeclock events to automate functions for lights</p>	<p data-bbox="927 481 1015 504">Reporting</p> <ul data-bbox="927 508 1321 741" style="list-style-type: none"> • Activity Report: Shows what activity has taken place over a period of time for one or more areas. Activity includes occupant activities (i.e., areas going occupied/unoccupied, wall controls being pressed), building manager operation (controlling/changing areas using the control and monitor tool), and device failures (keypads, ballasts, etc., that are not responding) • Lamp Failure Report: Shows which areas are currently reporting lamp failures <p data-bbox="946 763 1054 786">Diagnostics</p> <p data-bbox="946 790 1321 871">Diagnostics allows the building manager to check on the status of all equipment in the light control system. Devices will be listed with a reporting status of OK, Missing, or Unknown</p> <p data-bbox="946 893 1082 916">Administration</p> <ul data-bbox="927 920 1326 1424" style="list-style-type: none"> • Users: Allows new user accounts to be created, and existing user accounts to be edited • Publish Graphical Floorplan: Allows "Admin" user to publish new graphical floorplan files • Back-Up Project Database: Allows "Admin" user to back up the project database. The project database holds all the configuration information for the system, including keypad programming, area scenes, daylighting, occupancy programming, emergency levels, night lights, and timeclock. The Control and Monitor tool can be used to adjust some of these settings, and thus it is important to back up the project database prior to changing settings • Publish Project Database: Allows the "Admin" user to send a new project database to the server and download the new configuration to the system. The project database holds all the configuration information for the system, including keypad programming, area scenes, daylighting, occupancy programming, emergency levels, night lights, and timeclock <p data-bbox="946 1447 1123 1469">Required Hardware</p> <ul data-bbox="927 1473 1326 1536" style="list-style-type: none"> • Lutron Q-Manager™ server (if running Q-Admin software) • Lutron Quantum light management hub <p data-bbox="946 1559 1110 1581">Optional Software</p> <ul data-bbox="927 1585 1302 1648" style="list-style-type: none"> • Lutron Q-Admin client PC • Lutron Green Glance™ client PC and Green Glance™ software license <p data-bbox="946 1671 1118 1693">Licences Required</p> <ul data-bbox="927 1697 1161 1720" style="list-style-type: none"> • One license per processor 	<p data-bbox="1353 481 1453 504">QSW-L-PP-A</p>

Product	Control and Monitoring	Reporting and Administration	Part Number
	<p>Q-ADMIN™ SOFTWARE/QUANTUM™ PROCESSOR SOFTWARE: SHADE CONTROL AND MONITORING</p> <p>Optional Graphical Floorplan View The Q-Admin system navigation and status reporting is performed using customised CAD-based drawings of your building. Pan and Zoom features allow for easy navigation. Basic system view is always available. Contact Lutron for custom pricing.</p> <p>Control of Shades</p> <ul style="list-style-type: none"> • Area shades can be monitored for current preset or position • Area shades can be opened/closed, sent to a preset, or sent to a specific position <p>Scheduling Schedule time of day and astronomic timeclock events to automate functions for shades</p> <p>Hyperion™ Solar Clock Maximise the use of available daylight to produce a comfortable and productive visual environment that reduces glare and saves energy. During the day, the Hyperion algorithm calculates the exact position of the sun and moves the shades to block direct sun, which can cause uncomfortable glare and heat gain. At night, the shades are lowered to minimise light pollution and provide a uniform appearance. The system also allows the user to manually override the Hyperion shade control, such as on a very cloudy day</p>	<p>Reporting</p> <ul style="list-style-type: none"> • Activity Report: Shows what activity has taken place over a period of time for one or more areas. Activity includes occupant activities (i.e., wall controls being pressed), building manager operation (controlling/changing areas using the control and monitor tool), and device failures (keypads, shades, etc., that are not responding) <p>Diagnostics Diagnostics allows the building manager to check on the status of all equipment in the light control system. Devices will be listed with a reporting status of OK, Missing, or Unknown</p> <p>Administration</p> <ul style="list-style-type: none"> • Users: Allows new user accounts to be created, and existing user accounts to be edited • Publish Graphical Floorplan: Allows “Admin” user to publish new graphical floorplan files • Back-Up Project Database: Allows “Admin” user to back up the project database. The project database holds all the configuration information for the system, including keypad programming, area scenes, daylighting, occupancy programming, emergency levels, night lights, and timeclock. The Control and Monitor tool can be used to adjust some of these settings, and thus it is important to back up the project database prior to changing settings • Publish Project Database: Allows the “Admin” user to send a new project database to the server and download the new configuration to the system. The project database holds all the configuration information for the system, including keypad programming, area scenes, daylighting, occupancy programming, emergency levels, night lights, and timeclock <p>Required Hardware</p> <ul style="list-style-type: none"> • Lutron Q-Manager™ server (if running Q-Admin software) • Lutron Quantum light management hub <p>Optional Software</p> <ul style="list-style-type: none"> • Lutron Q-Admin client PC • Lutron Green Glance™ client PC and Green Glance™ software license <p>Licences Required</p> <ul style="list-style-type: none"> • One license per processor 	<p>QSW-S-PP-A</p>

See page 48 for detailed System/Wiring Diagrams.

Product	Control and Monitoring	Reporting and Administration	Part Number
---------	------------------------	------------------------------	-------------



See page 48 for detailed System/Wiring Diagrams.

GREEN GLANCE™ AND ENERGY REPORTING SOFTWARE

Energy Data Logging

An energy calculation and logging software package will be installed on your Quantum Q-Manager™ server

IntelliDemand

Occupancy allows the building manager (or security guard) to monitor occupancy status and make occupancy setting changes as follows:

- Displays real-time building power usage for the current day
- Shed lighting load in the entire building, or in selected areas

Reporting

- Energy Reports: Show a comparison of cumulative energy used over a period of time for one or more building areas
- Power Reports: Show power usage trends over a period of time for one or more building areas

Real-Time Energy Savings

Historical Time Periods:

- 3 hour energy savings
- 1 day energy savings
- 1 week energy savings
- 1 month energy savings
- 1 year energy savings
- Compare historical periods (days, weeks, months, years)

Energy Savings Over Time Period

Displayed in:

- kWh saved
- Dollars saved
- CO₂ not emitted
- Coal not burned

Other Data Displayed

- Local weather conditions (Internet connection required)
- Project information

Information Displayed in U.S. Format:

- Language: English
- U.S. currency
- U.S. time and date format

Required

- Quantum light management system
- Lutron Q-Manager™ server
- Green Glance client PC (model #QSW-GG-PP-A)
For customer-supplied PC, PC must meet minimum specification of model #QS-A-CMP-D-O.
- User-supplied Green Glance display (TV/monitor)

Licences Required

- One license per processor

Notes

- Maximum 6 concurrent Green Glance displays.

QSW-GG-PP-A

Software & Client Licences

Product	Description	Part Number
---------	-------------	-------------

QUANTUM LIGHT & SHADES



BACNET® SOFTWARE LICENSE FOR QUANTUM LIGHTS

This license for BACnet software enables a building management system to control, monitor, and manage energy for lights in the Quantum system. This license must be activated by a Lutron Field Service Engineer. One license is required for each processor

BACnet® Protocol Implementation Conformance Statement (PICS)

Date: September 10, 2008
 Vendor Name: Lutron Electronics Co., Inc.
 Product Name: Quantum BACnet Integration
 Product Model Number: QSW-BAC-L-PP-A
 Applications Software Version:
 Firmware Revision:
 BACnet® Protocol Revision: 2

Product Description

License for Quantum light management hub to enable BACnet IP Integration. Allows control of Quantum system components. BACnet IP is embedded in the Quantum light management hub

BACnet Interoperability Building Blocks Supported (Annex K):

K.1.1 BIBB	Data Sharing	ReadProperty-B (DS-RP-B)
K.1.8 BIBB	Data Sharing	WriteProperty-B (DS-WP-B)
K.1.4 BIBB	Data Sharing	ReadPropertyMultiple-B (DS-RPM-B)
K.1.10 BIBB	Data Sharing	WritePropertyMultiple-B (DS-WPM-B)
K.5.2 BIBB	Device Management	DynamicDeviceBinding-B (DM-DDB-B)
K.5.6 BIBB	Device Management	DeviceCommunicationControl-B (DM-DCC-B)

See page 48 for detailed System/Wiring Diagrams.

BACnet Standardised Device Profile (Annex L):

BACnet Application Specific Controller (B-ASC)

Segmentation Capability:

Segmented requests supported? No.
 Window Size: n/a

Segmented responses supported? No.
 Window Size: n/a

Non-Standard Application Services:

Non-standard application services are not supported

Standard Object Types Supported: Device

- 1 Dynamically creatable using BACnet's CreateObject service: No
- 2 Dynamically deletable using BACnet's DeleteObject service: No
- 3 List of optional properties supported: None
- 4 List of all properties that are writable where not otherwise required by this standard: None
- 5 List of proprietary properties: None
- 6 List of any property value range restrictions: None

Analog Value

- 1 Dynamically creatable using BACnet's CreateObject service: No
- 2 Dynamically deletable using BACnet's DeleteObject service: No
- 3 List of optional properties supported: Min, Max
- 4 List of all properties that are writable where not otherwise required by this standard: None
- 5 List of proprietary properties: None
- 6 List of any property value range restrictions: See Table

Analog Input

- 1 Dynamically creatable using BACnet's CreateObject service: No
- 2 Dynamically deletable using BACnet's DeleteObject service: No
- 3 List of optional properties supported: None
- 4 List of all properties that are writable where not otherwise required by this standard: None
- 5 List of proprietary properties: None
- 6 List of any property value range restrictions: See Table

Multi-State Value

- 1 Dynamically creatable using BACnet's CreateObject service: No
- 2 Dynamically deletable using BACnet's DeleteObject service: No
- 3 List of optional properties supported: None
- 4 List of all properties that are writable where not otherwise required by this standard: None
- 5 List of proprietary properties: None
- 6 List of any property value range restrictions: See Table

Data Link Layer Options:

BACnet IP

Device Address Binding:

Is static device binding supported: No

Networking Options:

None

Character Sets Supported:

Indicating support for multiple character sets does not imply that they can all be supported simultaneously. ANSI X3.4

If this product is a communication gateway, describe the types of non-BACnet equipment/network(s) that the gateway supports:

The device is a communication gateway between the BACnet protocol and modules in Lutron's Quantum light control system

QSW-BAC-L-PP-A
 QSW-BAC-S-PP-A

CCP – Custom Combination Panels



Lutron's dimming panels provide the power behind the GRAFIK systems line of products.

A variety of panels are available to meet the performance and budget requirements of any project.

Power panels have been designed to work independently or combined together to meet the requirements of any project. Lutron® can also further customise individual panels.

The following four pages will give you all the information you need to have on our GP and LP panels as well as their components.

CCP – Custom Combination Panels

Product	Features	Specifications/Dimensions	Part Number
	<p>GP DIMMING PANELS</p> <ul style="list-style-type: none"> For higher 230V loads with Luton's patented filter circuit, RTISS™ (Real Time Illumination Stability System) Offered in two cabinet sizes containing from 3-24 circuits Preassembled panels, field wiring is similar to wiring lighting distribution panel Filter chokes provide a rise time of at least 165 µsec at 50% dimmer capacity, measured from 10-90% of the load current waveform at 90% conduction angle and at no point faster than 60 mA/µsec Custom panels available if needs are beyond 24 circuits <p>Loads:</p> <ul style="list-style-type: none"> Incandescent Magnetic Low-Voltage Electronic Low-Voltage, leading edge only Neon/Cold Cathode High-Intensity Discharge (non-dim switching) <p>Design Options</p> <ul style="list-style-type: none"> Input feed – feed through, isolator switch Branch breakers – 10 A (CE) Panel voltage, 230V (CE) Panel feed – single phase or three phase Number of circuits: 3, 4, 8, 12, 16, 20, 24 2Link™ option – provides a second control link that automatically detects the presence of a DMX512 stage console Custom panels available if needs are beyond 24 circuits 	<p>Power</p> <ul style="list-style-type: none"> Operates on 50 or 60Hz power Can control most popular 230V loads 3 Phases, 400V 230V, CE. Input 16mm² <p>System Capabilities/Limits</p> <p>Panels with breakers</p> <ul style="list-style-type: none"> Dimming 3, 8, 12, 16, 20 and 24 dimmers <p>Panels without breakers</p> <ul style="list-style-type: none"> Dimming 3, 4, 8, 12, 16, 20 and 24 dimmers <p>Size in mm</p> <p>W: 703mm (27.65 in) H: 997mm (39.25 in) D: 305mm (12.00 in)</p> <p>Weight</p> <p>52 Kg max. (115 lbs)</p> <p>Ship Weight</p> <p>75 Kg max. (165 lbs)</p> <p>Heat Dissipation</p> <p>1365 BTUs/hour max.</p> <p>Environment</p> <ul style="list-style-type: none"> 0-40°C, (32-104°F). Relative humidity less than 90% non-condensing 	<p>Please contact our customer service for part numbers</p> <p>Example: Without breakers GP4-2304FTML-CE (1 link)</p> <p>With breakers GP12-2304IS-CE (1 link)</p>

See page 49 for detailed System/Wiring Diagrams.

Product	Features	Specifications/Dimensions	Part Number
---------	----------	---------------------------	-------------



See page 50 for detailed System/Wiring Diagrams.

LP DIMMING PANELS

- Ideal for projects with lots of small loads
- Provide power and dimming for up to 32 dimming legs/24 dimming and switching
- Work directly with incandescent, magnetic low voltage, neon/cold cathode lighting, 0-10V, DSI, DALI electronic low voltage lighting

Models available with:

- 230V (CE) input power 100-127V, 220-240V
- 1-8 dimming modules for up to 32 dimming legs, 24 switching legs
- Different feed types and breakers.
- Prewired by Lutron

LP Dimming Panels work with

- Quantum
- GRX-4000 Control Units
- GRAFIK 5000, 6000, 7000
- DMX512 dimming systems via the 2LINK™ option

Power

- 3 Phases, 400V 230V, CE
- Input 16mm²

System Capabilities/Limits

- Panels with breakers
- Dimming only 8 modules maximum per panel
 - Dimming and switching 6 modules max. per panel

Panels without breakers

- Dimming only 8 modules maximum per panel
- Dimming and switching 6 modules max. per panel
- Switching only 6 modules max

Size in mm

- W: 380mm (15.13 in)
- H: 1500mm (59 in)
- D: 100mm (5.07 in)

Weight

37 Kg max. (80 lbs)

Heat Dissipation

600 BTUs/hour max

Environment

- 0-40°C (32-104°F). Relative humidity less than 90% non-condensing

Example:



With breakers
CCP-2L2X2A2F-2304-IS-2 link

Without breakers
CCP-2L2X2A2F-2304-ML-2 link

CCP – Modules for Panels

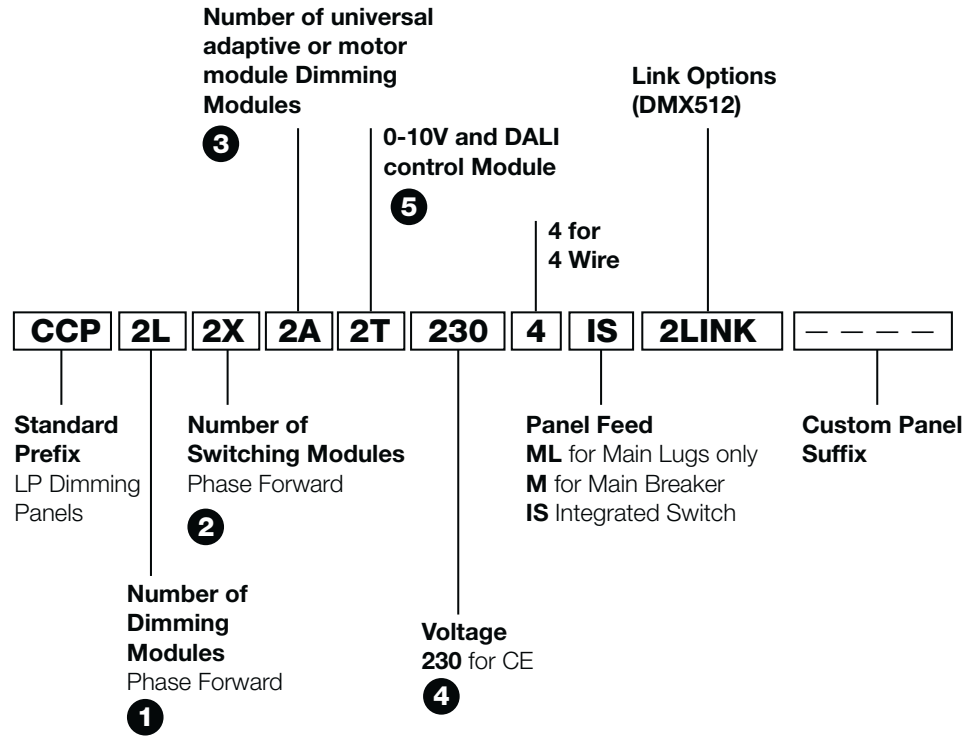
How to create a model number for the LP panels



Product	Features	Specifications/Dimensions	Part Number
	LP DIMMING MODULE 1 <ul style="list-style-type: none"> 1 input and 4 outputs per module Maximum loads (CE): 10 A per output 13 A continuous total per module Maximum loads (non-CE): 16 A per output 16 A continuous total per module Maximum 80 BTUs/hour. 	Loads <ul style="list-style-type: none"> Incandescent Magnetic low voltage Fluorescent (switching only) Neon/cold cathode Non-dim for above load types 	LP-RPM-4U-CE
	SWITCHING MODULE 2 <ul style="list-style-type: none"> Switches all lighting loads 4 inputs and 4 outputs Softswitch™ technology Maximum load: 16 A per output Maximum 5 BTUs/hour 	Loads <ul style="list-style-type: none"> Incandescent Magnetic low voltage Electronic low voltage Fluorescent Neon/cold cathode High intensity discharge 	XP2-Module
	ADAPTIVE MODULE 3 With NEW RTISS-TE™ Filter Technology <ul style="list-style-type: none"> Manual or automatic selection between leading edge or trailing edge dimming 1 input and 4 outputs per module Maximum loads (CE and non-CE): 8 A per output 13 A continuous total per module Maximum 100 BTUs/hour NO SWITCHING 	Loads <ul style="list-style-type: none"> Incandescent Magnetic low voltage Electronic low voltage Neon/cold cathode 	LP-RPM-4A-CE

Product	Features	Specifications/Dimensions	Part Number
---------	----------	---------------------------	-------------



ELV DIMMING MODULE **3**

- 1 input and 4 outputs per module
- Maximum loads (CE and non-CE):
10 A per output
16 A continuous total per module
- Maximum 100 BTUs/hour

Loads

- ⚡ Electronic low voltage
- 💡 Incandescent

LP-RPM-4E-CE



MOTOR MODULE **3**

- 1 input and 4 dual outputs
- Controls up to 4 3-wire AC motors
- Maximum load per motor module is 16 A
- Maximum load per AC motor is 5 A
- Does not work together in combination with XP & TVM Modules

Loads

- ⚙️ AC Motors

LP-RPM-4M-CE



TVM MODULE **5**

- Each module controls 2 consecutive dimming legs of lighting for 0-10 V, DALI (broadcast intensity only), DSI ballasts, or PWM ballasts
- For every 2 TVM Modules 1 LP Dimming or XP switching module **MUST** be present
- 50 mA maximum low voltage ballast control current per dimming leg
- 750 mA maximum low voltage ballast control current per panel
- Sinks and sources current
- 2 outputs per module
- Requires switching output in addition

Loads

- ➡️ Fluorescent Ballast
- ➡️ Fluorescent Ballast (0-10 V, DSI ballasts, DALI Broadcast and PWM ballasts)

GRX-TVM2

Shades

Product	Features	Specifications/Dimensions	Part Number
---------	----------	---------------------------	-------------



Tube size (diameter of tube only – no shade fabric) 32mm (1.25 in)

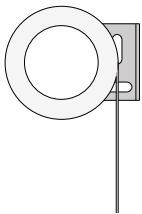

SIVOIA QS – ROLLER 64 FOR SHADES UP TO 5.95 M² (64 SQ.FT.)

- Ultra-quiet operation: will not exceed 44 dBA measured 1m (3ft) from the EDU
- Shades move in perfect unison and exact alignment within 3mm (0.125 in) accuracy at all times
- Smooth, silent starts, and stops
- Offers programmable stop points. The EDU tracks the position of the shade and is able to adjust it to predetermined locations at the touch of a button
- Provides maximum window coverage with the smallest possible light gaps, 19mm (0.75 in) between the shade fabric and the window frame. Light gaps are symmetrical on both sides of shade
- Easy-to-read and easy-to-use controls are immediately understood
- Does not require group controls or relay systems to create shade groups and sub-groups
- 24 V~ low-voltage power
- Power failure memory for the lifetime of the product
- 8 year limited warranty

Fabric options

Sivoia QS Roller shades are available in a wide variety of fabric types including:

- Sheer – Filter sunlight, UV protection, view
- Privacy – Minimal translucence, UV protection
- Blackout – Total darkness, maximum UV protection, no view

System Capacity

- System allows for a total of 100 devices, such as a Sivoia QS shade, a seeTouch® QS keypad, a GRAFIK Eye® QS, and QS power supplies
- System allows for a total of 100 zones, including Sivoia QS shades and GRAFIK Eye QS
- Maximum size of shade fabric per EDU is 6 sq m (64 sqft)

Performance

- System allows for symmetrical light gaps as small as 19mm (0.75 in) on each side
- Each EDU stores presets positioned at any stop point along the shade's travel, as well as full open and full close shade limits
- Each EDU is capable of stopping with the accuracy of 3mm (0.125 in) steps for the entire travel of the shade
- Preset points can be located at any point between the open/close limits and are adjustable with a 5 second button push and hold from the seeTouch QS keypads or GRAFIK Eye QS
- For systems with multiple EDUs, shades smoothly move in unison and exact alignment within 3mm (0.125 in) accuracy at all times
- Limits are programmable and adjustable from the EDUs, wall-mounted seeTouch QS keypads and/or GRAFIK Eye QS

Grouping

- System keypads can control any EDU, group, or subgroup without a separate group controller or additional interface
- System groups and subgroups can be reconfigured at the point of control without rewiring and without access to the EDU
- Controls within this system are able to operate any group or subgroup of EDUs, regardless of window treatment type

Integration

- EDUs seamlessly integrate with Lutron lighting control, GRAFIK Eye QS, without a separate interface
- Contact closure, RS232, and ethernet available to integrate with A/V equipment such as timeclocks and security systems

Controls

- Sivoia QS shades can be controlled by built-in shade columns on a GRAFIK Eye QS, or by seeTouch QS keypads
- seeTouch QS keypads are low voltage
- Microprocessors are contained in the EDU, GRAFIK Eye QS, and seeTouch QS keypads, allowing high level programming from either source
- All Sivoia QS shades, GRAFIK Eye QS and seeTouch QS keypads are wired together on the same communications link

Power

- Operating voltage: Low-voltage Class 2, 24 V~ power supply required
- Control system power supply offers (spike and brownout) overvoltage protection (+/- 10% of line voltage) for all devices in the system
- Power supply provides appropriate Electro Static Discharge (ESD) protection for all devices in the system
- Power must be derived from a Lutron approved NEC Class 2 power source

Please contact our customer service for part numbers as this product will need to be quoted with fabric.

Dimensions

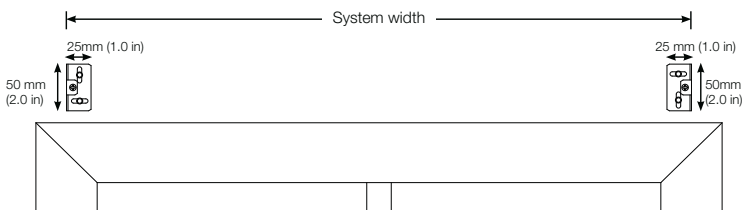

Complete Assembly

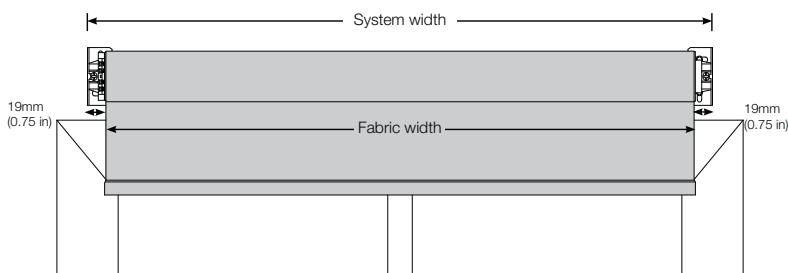

(Wall brackets shown)

See page 51 for detailed System/Wiring Diagrams.

Product

Features

Specifications/Dimensions

Part Number



Tube size (diameter of tube only – no shade fabric) 65mm (2.56 in)

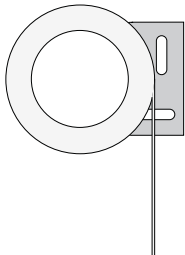

SIVOIA QS – ROLLER 100 FOR SHADES UP TO 9.29 M² (100 SQ.FT.)

- Ultra-quiet operation: will not exceed 44 dBA measured 1m (3ft) from the EDU
- Shades move in perfect unison and exact alignment within 3mm (0.125 in) accuracy at all times
- Smooth, silent starts, and stops
- Offers programmable stop points. The EDU tracks the position of the shade and is able to adjust it to predetermined locations at the touch of a button
- Provides maximum window coverage with the smallest possible light gaps, 19mm (0.75 in) between the shade fabric and the window frame. Light gaps are symmetrical on both sides of shade
- Easy-to-read and easy-to-use controls are immediately understood
- Does not require group controls or relay systems to create shade groups and sub-groups
- 24 V~ low-voltage power
- Power failure memory for the lifetime of the product
- 8 year limited warranty

Fabric options

- Sivoia QS Roller shades are available in a wide variety of fabric types including:
- Sheer – Filter sunlight, UV protection, view
 - Privacy – Minimal translucence, UV protection
 - Blackout – Total darkness, maximum UV protection, no view

System Capacity

- System allows for a total of 100 devices, such as a Sivoia QS shade, a seeTouch® QS keypad, a GRAFIK Eye® QS, and QS power supplies
- System allows for a total of 100 zones, including Sivoia QS shades and GRAFIK Eye QS
- Maximum size of shade fabric per EDU is 10sq m (100 sqft)

Performance

- System allows for symmetrical light gaps as small as 19mm (0.75 in) on each side
- Each EDU stores presets positioned at any stop point along the shade's travel, as well as full open and full close shade limits
- Each EDU is capable of stopping with the accuracy of 3mm (0.125 in) steps for the entire travel of the shade
- Preset points can be located at any point between the open/close limits and are adjustable with a 5 second button push and hold from the seeTouch QS keypads or GRAFIK Eye QS
- For systems with multiple EDUs, shades smoothly move in unison and exact alignment within 3mm (0.125 in) accuracy at all times
- Limits are programmable and adjustable from the EDUs, wall-mounted seeTouch QS keypads and/or GRAFIK Eye QS

Grouping

- System keypads can control any EDU, group, or subgroup without a separate group controller or additional interface
- System groups and subgroups can be reconfigured at the point of control without rewiring and without access to the EDU
- Controls within this system are able to operate any group or subgroup of EDUs, regardless of window treatment type

Integration

- EDUs seamlessly integrate with Lutron lighting control, GRAFIK Eye QS, without a separate interface
- Contact closure, R232, and ethernet available to integrate with A/V equipment such as timeclocks and security systems

Controls

- Sivoia QS shades can be controlled by built-in shade columns on a GRAFIK Eye QS, or by seeTouch QS keypads
- seeTouch QS keypads are low voltage
- Microprocessors are contained in the EDU, GRAFIK Eye QS, and seeTouch QS keypads, allowing high level programming from either source
- All Sivoia QS shades, GRAFIK Eye QS and seeTouch QS keypads are wired together on the same communications link

Power

- Operating voltage: Low-voltage Class 2, 24 V~ power supply required
- Control system power supply offers (spike and brownout) overvoltage protection (+/- 10% of line voltage) for all devices in the system
- Power supply provides appropriate Electro Static Discharge (ESD) protection for all devices in the system
- Power must be derived from a Lutron approved NEC Class 2 power source

Please contact our customer service for part numbers as this product will need to be quoted with fabric.

Dimensions

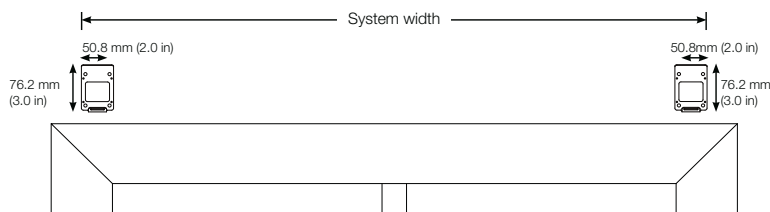

Complete Assembly

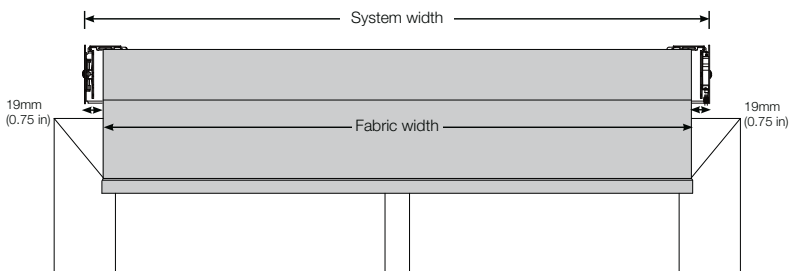

(Wall brackets shown)

See page 51 for detailed System/Wiring Diagrams.

Shades

Product	Features	Specifications/Dimensions	Part Number
---------	----------	---------------------------	-------------



Tube size (diameter of tube only - no shade fabric) 65mm (2.56 in)

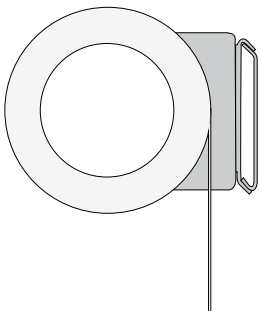

Dimensions

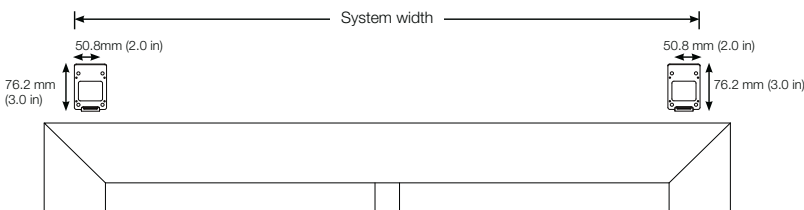

Complete Assembly

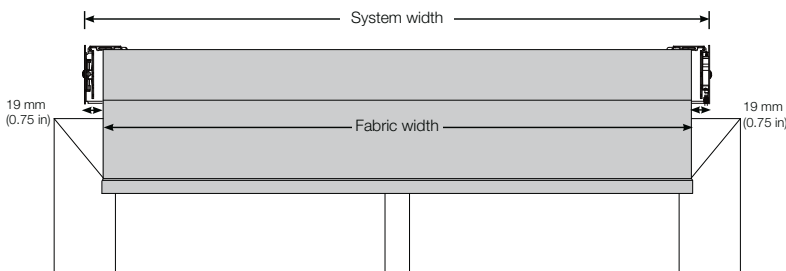

(Wall brackets shown)

SIVOIA QS – ROLLER 200CW FOR SHADES UP TO 18.6 M² (200 SQ.FT.)

- Ultra-quiet operation: will not exceed 44 dBA measured 1m (3ft) from the EDU
- Shades move in perfect unison and exact alignment within 3mm (0.125 in) accuracy at all times
- Smooth, silent starts, and stops
- Offers programmable stop points. The EDU tracks the position of the shade and is able to adjust it to predetermined locations at the touch of a button
- Provides maximum window coverage with the smallest possible light gaps, 19mm (0.75 in) between the shade fabric and the window frame. Light gaps are symmetrical on both sides of shade
- Control up to 6 shade panels with one EDU
- Provide smooth subtle transitions as shades move slowly and evenly
- Easy-to-read and easy-to-use controls are immediately understood
- Does not require group controls or relay systems to create shade groups and sub-groups
- 24 V~ low-voltage power
- Power failure memory for the lifetime of the product
- 8 year limited warranty

Fabric options

- Sivoia QS Roller shades are available in a wide variety of fabric types including:
- Sheer – Filter sunlight, UV protection, view
 - Privacy – Minimal translucence, UV protection
 - Blackout – Total darkness, maximum UV protection, no view

System Capacity

- System allows for a total of 100 devices, such as a Sivoia QS shade, a seeTouch® QS keypad, a GRAFIK Eye® QS, and QS power supplies
- System allows for a total of 100 zones, including Sivoia QS shades and GRAFIK Eye QS
- Maximum size of shade fabric per EDU is 18.6 sq m (200 sqft)

Performance

- System allows for symmetrical light gaps as small as 19mm (0.75 in) on each side
- Each EDU stores presets positioned at any stop point along the shade's travel, as well as full open and full close shade limits
- Each EDU is capable of stopping with the accuracy of 3mm (0.125 in) steps for the entire travel of the shade
- Preset points can be located at any point between the open/close limits and are adjustable with a 5 second button push and hold from the seeTouch QS keypads or GRAFIK Eye QS
- For systems with multiple EDUs, shades smoothly move in unison and exact alignment within 3mm (0.125 in) accuracy at all times
- Limits are programmable and adjustable from the EDUs, wall-mounted seeTouch QS keypads and/or GRAFIK Eye QS

Grouping

- System keypads can control any EDU, group, or subgroup without a separate group controller or additional interface
- System groups and subgroups can be reconfigured at the point of control without rewiring and without access to the EDU
- Controls within this system are able to operate any group or subgroup of EDUs, regardless of window treatment type

Integration

- EDUs seamlessly integrate with Lutron lighting control, GRAFIK Eye QS, without a separate interface
- Contact closure, R232, and ethernet available to integrate with A/V equipment such as timeclocks and security systems

Controls

- Sivoia QS shades can be controlled by built-in shade columns on a GRAFIK Eye QS, or by seeTouch QS keypads
- seeTouch QS keypads are low voltage
- Microprocessors are contained in the EDU, GRAFIK Eye QS, and seeTouch QS keypads, allowing high level programming from either source
- All Sivoia QS shades, GRAFIK Eye QS and seeTouch QS keypads are wired together on the same communications link

Power

- Operating voltage: Low-voltage Class 2, 24 V~ power supply required
- Control system power supply offers (spike and brownout) overvoltage protection (+/- 10% of line voltage) for all devices in the system
- Power supply provides appropriate Electro Static Discharge (ESD) protection for all devices in the system
- Power must be derived from a Lutron approved NEC Class 2 power source

Please contact our customer service for part numbers as this product will need to be quoted with fabric.

See page 51 for detailed System/Wiring Diagrams.

Product	Features	Specifications/Dimensions	Part Number
---------	----------	---------------------------	-------------



Tube size (diameter of tube only - no shade fabric) 95mm (3.75 in)

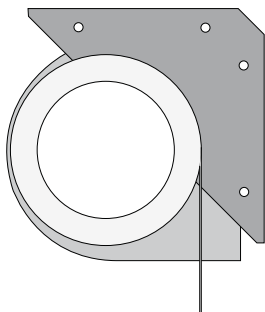

Dimensions

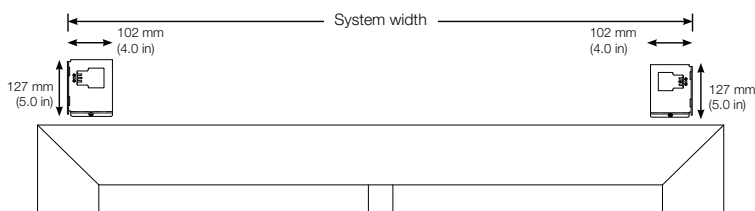

Complete Assembly

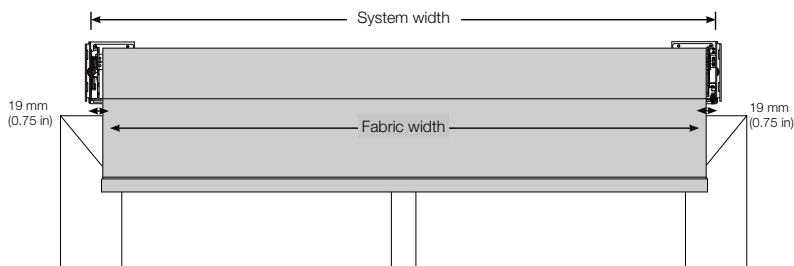

SIVOIA QS – ROLLER 225 FOR SHADES UP TO 20.9 M² (225 SQ.FT.)

- Ultra-quiet operation: will not exceed 44 dBA measured 1m (3ft) from the EDU
- Shades move in perfect unison and exact alignment within 3mm (0.125 in) accuracy at all times
- Smooth, silent starts, and stops
- Offers programmable stop points. The EDU tracks the position of the shade and is able to adjust it to predetermined locations at the touch of a button
- Provides maximum window coverage with the smallest possible light gaps, 19mm (0.75 in) between the shade fabric and the window frame. Light gaps are symmetrical on both sides of shade
- Easy-to-read and easy-to-use controls are immediately understood
- Does not require group controls or relay systems to create shade groups and sub-groups
- 24 V~ low-voltage power
- Power failure memory for the lifetime of the product
- 8 year limited warranty

Fabric options

- Sivoia QS Roller shades are available in a wide variety of fabric types including:
- Sheer – Filter sunlight, UV protection, view
 - Privacy – Minimal translucence, UV protection
 - Blackout – Total darkness, maximum UV protection, no view

System Capacity

- System allows for a total of 100 devices, such as a Sivoia QS shade, a seeTouch® QS keypad, a GRAFIK Eye® QS, and QS power supplies
- System allows for a total of 100 zones, including Sivoia QS shades and GRAFIK Eye QS
- Maximum size of shade fabric per EDU is 21 sq m (225 sqft)

Performance

- System allows for symmetrical light gaps as small as 19mm (0.75 in) on each side
- Each EDU stores presets positioned at any stop point along the shade's travel, as well as full open and full close shade limits
- Each EDU is capable of stopping with the accuracy of 3mm (0.125 in) steps for the entire travel of the shade
- Preset points can be located at any point between the open/close limits and are adjustable with a 5 second button push and hold from the seeTouch QS keypads or GRAFIK Eye QS
- For systems with multiple EDUs, shades smoothly move in unison and exact alignment within 3mm (0.125 in) accuracy at all times
- Limits are programmable and adjustable from the EDUs, wall-mounted seeTouch QS keypads and/or GRAFIK Eye QS

Grouping

- System keypads can control any EDU, group, or subgroup without a separate group controller or additional interface
- System groups and subgroups can be reconfigured at the point of control without rewiring and without access to the EDU
- Controls within this system are able to operate any group or subgroup of EDUs, regardless of window treatment type

Integration

- EDUs seamlessly integrate with Lutron lighting control, GRAFIK Eye QS, without a separate interface
- Contact closure, RS232, and ethernet available to integrate with A/V equipment such as timeclocks and security systems

Controls

- Sivoia QS shades can be controlled by built-in shade columns on a GRAFIK Eye QS, or by seeTouch QS keypads
- seeTouch QS keypads are low voltage
- Microprocessors are contained in the EDU, GRAFIK Eye QS, and seeTouch QS keypads, allowing high level programming from either source
- All Sivoia QS shades, GRAFIK Eye QS and seeTouch QS keypads are wired together on the same communications link

Power

- Operating voltage: Low-voltage Class 2, 24 V~ power supply required
- Control system power supply offers (spike and brownout) overvoltage protection (+/- 10% of line voltage) for all devices in the system
- Power supply provides appropriate Electro Static Discharge (ESD) protection for all devices in the system
- Power must be derived from a Lutron approved NEC Class 2 power source

Please contact our customer service for part numbers as this product will need to be quoted with fabric.

See page 51 for detailed System/Wiring Diagrams.

Shades

Product

SIVOIA QS – D105 DRAPERY TRACK SYSTEM

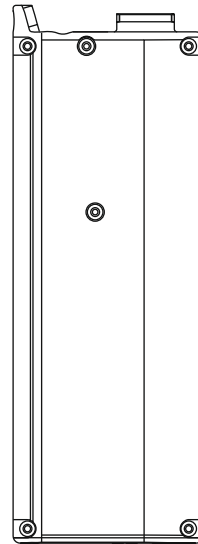

Sivoia QS Electronic Drive Unit (EDU)

Top view (single track, right draw)

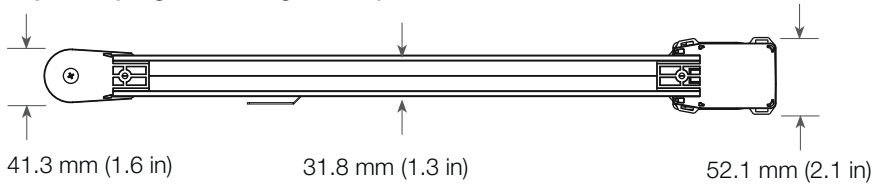

Front view (single track, right draw)

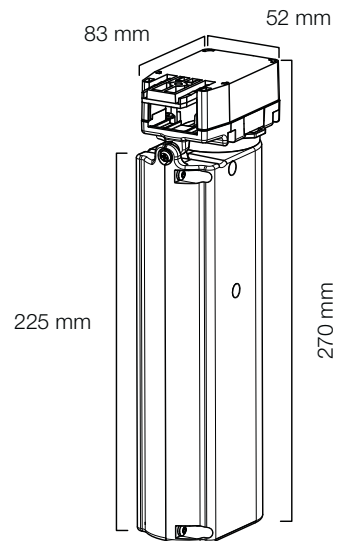
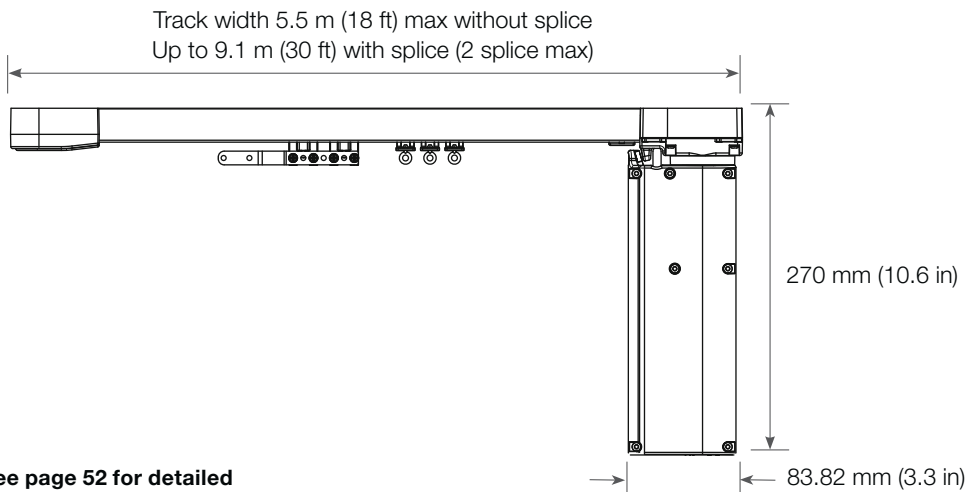

See page 52 for detailed System/Wiring Diagrams.

Features

- Smooth, ultra-quiet operation
- Draperies start, move, and stop with precision
- Offers programmable stop points. The EDU tracks the position of the drapery and is able to adjust it to predetermined locations at the touch of a button
- Single, dual, curved, single-tandem and dual-tandem tracks available
- Easy-to-read and easy-to-use controls are immediately understood
- Available in right, left, and center draw configurations
- Does not require group controllers or relay systems to create drapery groups and sub-groups
- Can be installed in new construction or retrofit application
- 24 V~ low-voltage power
- Power failure memory for the lifetime of the product
- Operates up to 105 lb (48 kg) draperies
- Manual open feature option available
- Track splicing option available with up to two splices per track
- Available in pinch pleat and ripplefold
- 8 year limited warranty
- System allows for a total of 100 devices, such as a Sivoia QS shade, a seeTouch® QS keypad, a GRAFIK Eye® QS, and QS power supplies
- System allows for a total of 100 zones, including Sivoia QS shades and GRAFIK Eye QS
- Maximum size of drapery fabric per EDU varies (refer to page 5)
- Drapery tracks can be spliced to join 2 or 3 equal sections for a total track length of 30ft
- Manual open feature available
- Available with pinch pleat carriers and ripplefold carriers

Optional Splicing Bar



Drive Belt

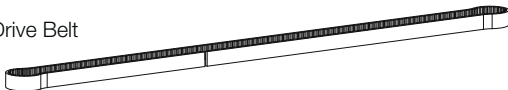

Idler Gear Housing



Track



Traditional Master Carrier

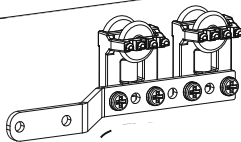

Auxiliary Carriers

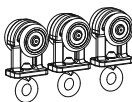

Cover



Optional Manual Open Master Carrier Available

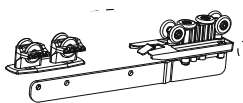

Sivoia QS EDU

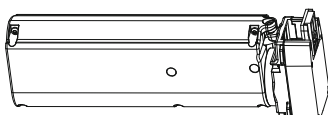

Specifications/Dimensions

Part Number

Audible noise

- Ultra-quiet operation (will not exceed 44 dBA measured 1m (3ft) from the EDU)
- Drapery track components designed for ultra-quiet operation

System performance

- Each EDU stores programmable presets including open, closed and any other position along the track
- Preset points can be located at any point between the open/close limits and are adjustable with a 5 second button push and hold from the seeTouch QS keypads or GRAFIK Eye QS
- For systems with multiple tracks, draperies move smoothly and in unison
- Limits are programmable and adjustable from the EDU's, wall-mounted seeTouch QS keypads and/or GRAFIK Eye QS
- Drapes with manual open option can be opened during a power loss, or manually by a user who is not aware the track is motorised
- Manual open feature compatible with drapery panels up to 70 lb (32 kg)

Grouping

- System keypads can control any EDU, group, or subgroup without a separate group controller or additional interface
- System groups and subgroups can be re-configured at the point of control without rewiring and without access to the EDU
- Controls within this system are able to operate any group or subgroup of EDU's, regardless of window treatment type Integration
- EDU's seamlessly integrate with Lutron lighting control, GRAFIK Eye QS, without a separate interface
- Contact closure, RS232, and ethernet available to integrate with A/V equipment such as timeclocks and security systems

Controls

- Sivoia QS shades can be controlled by built-in shade columns on a GRAFIK Eye QS, or by seeTouch QS keypads
- seeTouch QS keypads are low voltage
- Microprocessors are contained in the EDU, GRAFIK Eye QS, and seeTouch QS keypads, allowing high level programming from either source
- All Sivoia QS shades, GRAFIK Eye QS and seeTouch QS keypads are wired together on the same communications link

Power

- Operating voltage: Low-voltage class 2, 24 V~ power supply required
- Control system power supply offers (spike and brownout) overvoltage protection (+/- 10% of line voltage) for all devices in the system
- Power supply provides appropriate Electro Static Discharge (ESD) protection for all devices in the system
- Power must be derived from a Lutron approved NEC Class 2 power source

Please contact our customer service for part numbers

Shades

Product

SIVOIA QS – SKYLIGHT SHADE SYSTEM

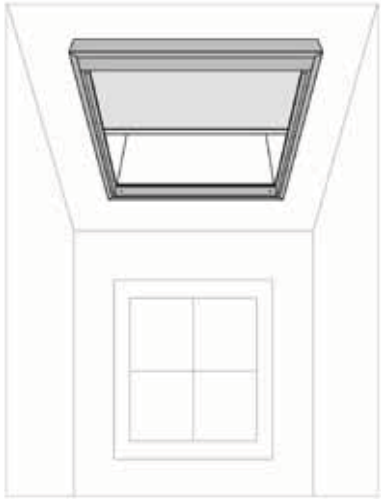
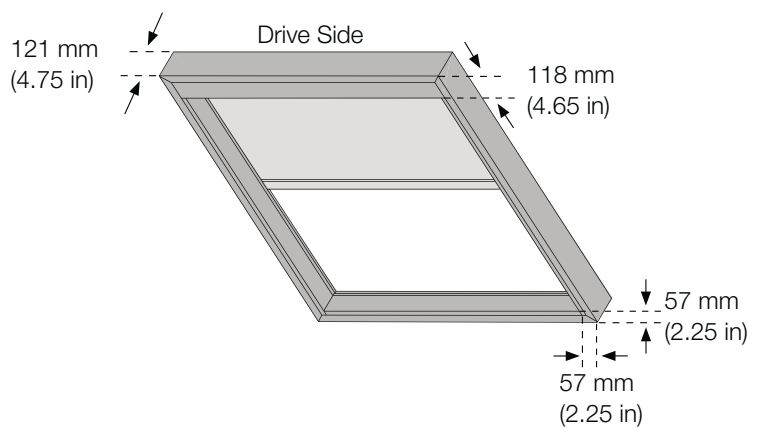

See page 53 for a detailed wiring diagram.

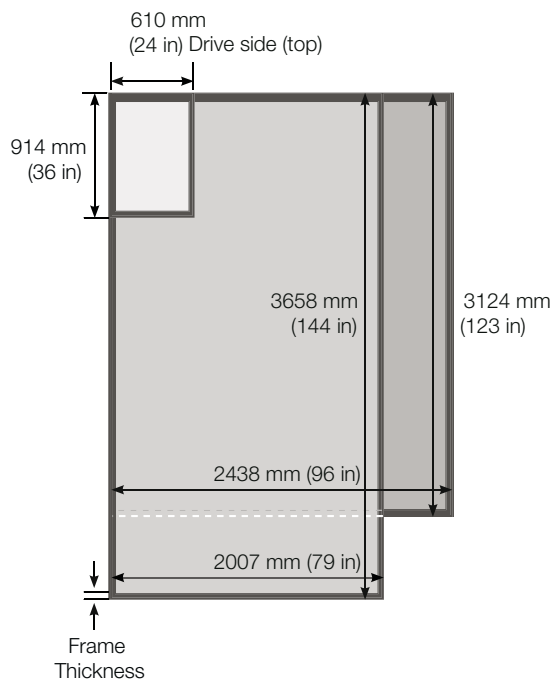

- Minimum system size:
610 mm wide x 914 mm long
(24 in wide x 36 in long)
- Longest system:
2005 mm wide x 3658 mm long
(79 in wide x 144 in long)
- Widest system:
2438 mm wide x 3124 mm long
(96 in wide x 123 in long)
- Frame thickness:
Drive end: 118 mm (4.65 in)
Non-drive end and sides: 57 mm (2.25 in)

NOTE

Skylight shade dimension limitations are a function of fabric selection and application angle. Please consult the SCT or customer service for details.

Features

SIVOIA QS – SKYLIGHT SHADE SYSTEM

Aesthetics

- Light-blocking fascia eliminates light gaps around fabric when closed
- Concealed cable guides maximise view through skylight when open
- Wide variety of high performance fabrics to enhance décor

Design

- Unique tension-absorbing frame eliminates stress on the surrounding ceiling structure
- Reliable performance under extreme temperature is ensured by weld- and seam-free design
- The EDU requires only low-voltage wiring
- Operation
- Smooth, ultra-quiet operation
- Shades start, move and stop with precision
- Offers programmable stop points. The EDU tracks the position of the shade and is able to adjust it to predetermined locations at the touch of a button

- Easy-to-read and easy-to-use controls
- Smooth, quiet, precise movement of skylight shades creates elegant transitions
- One-touch control of hard-to-reach skylight shades through keypad or IR remote
- Seamless integration with the GRAFIK Eye® QS, Quantum™, Lutron lighting controls, and other A/V equipment
- Does not require group controllers or relay systems to create shade groups and sub-groups
- Flexible 0° to 45° installation
- Inside, recessed, and outside mounting options allow system to fit a wide variety of applications
- Can be shipped pre-assembled or as components to maximise on-site installation convenience and time savings (Refer to SCT for your application)
- Power failure memory for the lifetime of the product
- 8 year limited warranty
- Fiberglass based fabrics available for sheer, dim-out, and blackout

Specifications/Dimensions

Audible noise

- Skylight shade components designed for ultra-quiet operation (will not exceed 44 dBA measured 1m (3ft) from the EDU)

System Capacity

- System allows for a total of 100 devices, such as a Sivoia QS skylight shade, roller shade or drapery track, a seeTouch® QS keypad, a GRAFIK Eye® QS, and QS power supplies
- System allows for a total of 100 zones, including Sivoia QS shades, drapes and GRAFIK Eye QS lighting zones

System performance

- Each EDU stores presets positioned at any stop point along the shade's travel, as well as full open and full close shade limits
- Each EDU is capable of stopping with the accuracy of 3mm (0.125 in) steps for the entire travel of the shade
- Preset points can be located at any point between the open/close limits and are adjustable with a 5 second button push and hold from the seeTouch QS keypads or GRAFIK Eye QS
- For systems with multiple EDUs, shades smoothly move in unison and precise alignment within 3mm (0.125 in) accuracy at all times
- Limits are programmable and adjustable from the EDUs, wall-mounted seeTouch QS keypads and/or GRAFIK Eye QS

Grouping

- System keypads can control any EDU, group, or subgroup without a separate group controller or additional interface
- System groups and subgroups can be re-configured at the point of control without rewiring and without access to the EDU
- Controls within this system are able to operate any group or subgroup of EDUs, regardless of window treatment type

Integration

- EDUs seamlessly integrate with GRAFIK Eye QS and Quantum™ without a separate interface
- Contact closure, RS232, and ethernet available to integrate with A/V equipment and security systems

Controls





- Sivoia QS shades can be controlled by built-in shade columns on a GRAFIK Eye QS, or by seeTouch QS keypads
- seeTouch QS keypads are low voltage
- Microprocessors are contained in the EDU, GRAFIK Eye QS, and seeTouch QS keypads, allowing high level programming from any source
- All Sivoia QS shades, GRAFIK Eye QS and seeTouch QS keypads are wired together on the same communications link

Power

- Operating voltage: Low-voltage Class 2, 24 V_{AC} power supply required
- Control system power supply offers (spike and brownout) overvoltage protection (+/- 10% of line voltage) for all devices in the system
- Power supply provides appropriate Electro Static Discharge (ESD) protection for all devices in the system
- Power must be derived from a Lutron approved NEC Class 2 powersource

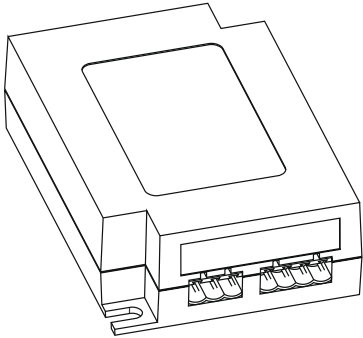
Please contact our customer service for part numbers

Power Supply

Product	Features	Specifications/Dimensions	Part Number
 <p>See page 54 for detailed System/Wiring Diagrams.</p>	<p>QS – LINK POWER SUPPLY</p> <ul style="list-style-type: none"> • 24 DC supply that provides power to shades, drapery drive units, keypads, and accessories • Simple wiring scheme uses 4-conductor, low voltage link to provide power and communication for QS electronic drive units (EDUs), see Touch® QS keypads and QS integration interfaces • Mounting tabs and small size allow for discrete installation • Universal input voltage (100-240 VAC) enables global specification 	<ul style="list-style-type: none"> • Input Voltage – 100-240 V • Input current (MAX) – 1 A • Output Voltage – 24 DC • Operating Frequency – 50/60 Hz • ESD Protection – (+/-) 16 kV • Miswire Protection – Electronic Automatic Reset • Input Wiring – available with 3 types of line cords. All 1.8m (6ft). Plugs into standard receptacle • QS Link Wiring – 4-conductor (power and communication) +24 V, COM, MUX, MUX • 3-conductor (communication pass-through) COM, MUX, MUX • Output connections – detachable terminal blocks 4-0.15mm² (12-26 AWG) stranded, twisted/shielded • Weight – 0.3 lb (0.14 kg) • Regulatory – UL (1310 CLASS2) <ul style="list-style-type: none"> – CE (IEC 61558) – CUL (CSA C22.2 #223) <p>Size in mm</p> <p>W: 70mm (2.75 in) H: 102mm (4 in) D: 31mm (1.2 in)</p>	<p>US QSPS-P1-1-50</p>  <p>Euro QSPS-P2-1-50</p>  <p>UK QSPS-P3-1-50</p> 

 <p>See page 55 for detailed System/Wiring Diagrams.</p>	<p>DIN RAIL QS POWER SUPPLY</p> <p>The STEP-PS QS link power supply provides up to 22 Power Draw Units on a QS link. The STEP-PS powers additional compatible accessories and devices, allowing them to be added to a QS system</p>	<p>Input Power</p> <ul style="list-style-type: none"> • Nominal input voltage: 100–240 V • Important: Only use this product for 220–240 V applications • Frequency: 50/60 Hz • Current consumption: approx. 0.8 A (230 V) <p>Power Supply Output</p> <ul style="list-style-type: none"> • Nominal output voltage and tolerance: 24 V / ±1%, 22 Power Draw Units* • Setting range of output voltage: 22.5–29.5 V; at time of shipment, the output voltage is 24 V * Power supply is rated to provide a maximum of 22 Power Draw Units to devices on the QS Link. Use above this maximum will reduce the lifetime of the supply and void all Lutron warranties <p>Standards</p> <ul style="list-style-type: none"> • Electrical Safety: IEC60950 / VDE 0805, UL/C-UL Recognised UL 60950 • Safety Transformer: EN61558-2-17 • Electronic equipment for electrical power installations: EN 50178 / VDE 0106-101 • Safe isolation: DIN VDE 0100-410 / DIN VDE 0106-101 • Industrial regulating devices: UL/C-UL Listed UL 508 • Shipbuilding: GL • Limitation of main harmonic currents: EN 61000-3-2 • Electromagnetic compatibility CE in conformance with EMC Guidelines: 2004/108/EG ; 2006/95/EG. <ul style="list-style-type: none"> - Immunity to interference: EN 61000-6-2 - Noise emission: EN 61000-6-3 <p>Environment</p> <ul style="list-style-type: none"> • Ambient temperature operation: -25 to +70°C (-13 to +158°F) (> 55°C / 131°F Derating 2.5% / K or 3.5% / F) • Ambient temperature storage: -40 to +85°C (-40 to +185°F) • Humidity at +25°C, no condensation: ≤ 95% <p>Size in mm</p> <p>W: 72mm (2.83 in) H: 150mm (5.9 in) D: 61mm (2.4 in)</p>	<p>STEP-PS/1AC/24DC/4.2-CPN5550</p>
--	--	---	-------------------------------------

Product	Features	Specifications/Dimensions	Part Number
---------	----------	---------------------------	-------------

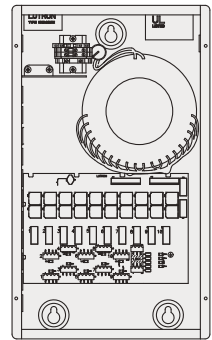
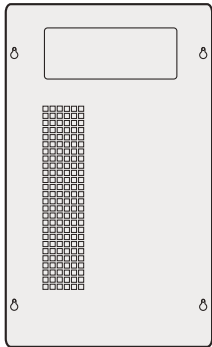

SIVOIA QS – 230V SMART PANEL POWER SUPPLY

- 24 V~ supply that provides power to shades, drapery drive units, keypads, and accessories
- Simple wiring scheme uses 4-conductor low voltage link to provide power and communication for both QS electronic drive units (EDUs) and seeTouch QS keypads
- Flexible wiring topology for easy installation and integration
- 10 output panel provides power for 10 to 30 shades based on shade dimensions
- Smart diagnostics reduce installation time and system verification
- Confirms system communication and facilitates system installation
- Provides easy system testing with manual override buttons for shades and lighting

- Input Voltage – 230 V~
- Input current per QSPS-P2-10-60 – 4A/Panel
Note: use only high magnetic breakers
- Output Voltage – 24 V~
- Output Current – 2.5 A
- Operating Frequency – 50/60 Hz
- ESD Protection – (+/-) 16 kV
- Miswire Protection – Fuse on each output
2 spares included (5x20mm, 2.5 A fuse)
- Wiring – Input wires to 230 V~ supply, output wires to Lutron QS lighting or shading devices
- Wiring type – Input wires: 6-2.5mm² (10-14 AWG) stranded
Output wires: 4 conductor 4-0.15mm² (12-26 AWG) stranded, twisted/shielded
- Connections – Terminal blocks
- Maximum QSPS-P2-10-60 – 2 panels per dedicated 10 A circuit
- Maximum QSPS-P2-10-60 – 2 panels per dedicated 10 A circuit
- Maximum feed breaker size – 30 A
- Weight 25 lbs (11.3 kg)
- Regulatory Approvals – CE

QSPS-P2-10-60

Size in mm

With cover
W: 262mm (10.30 in)
H: 465mm (18.30 in)
D: 99mm (3.9 in)

Without cover

W: 241mm (9.50 in)
H: 444mm (17.50 in)
D: 99mm (3.9 in)

See page 56 for detailed System/Wiring Diagrams.

System/Wiring Diagrams



Photography © Nic Lehoux

System/Wiring Diagrams Index

GRAFIK EYE QS WIRELESS (WITH DALI)	43
POWER BOOSTER & ELECTRONIC LOW VOLTAGE INTERFACE	43
ESN, WALLSTATIONS, SHADES	44
ESN WITH SENSORS AND DALI	44
SENSORS	45/46
CONTROL INTERFACE	47
ESN PROGRAMMING INTERFACE	47
PROCESSOR/SERVER/SOFTWARE/CLIENT LICENCES	48
GP DIMMING PANELS – INTERNAL OVERVIEW	49
LP DIMMING PANELS	50
SIVOIA QS – ROLLER 64, 100, 200CW AND 225	51
SIVOIA QS SYSTEM WIRING FOR DRAPERY SYSTEM	52
SIVOIA QS – SKYLIGHT SHADE	53
QS LINK POWER SUPPLY	54
DIN RAIL QS POWER SUPPLY	55
SIVOIA QS – 230V SMART PANEL POWER SUPPLY	56

GRAFIK EYE QS WIRELESS (WITH DALI)

Wiring Example

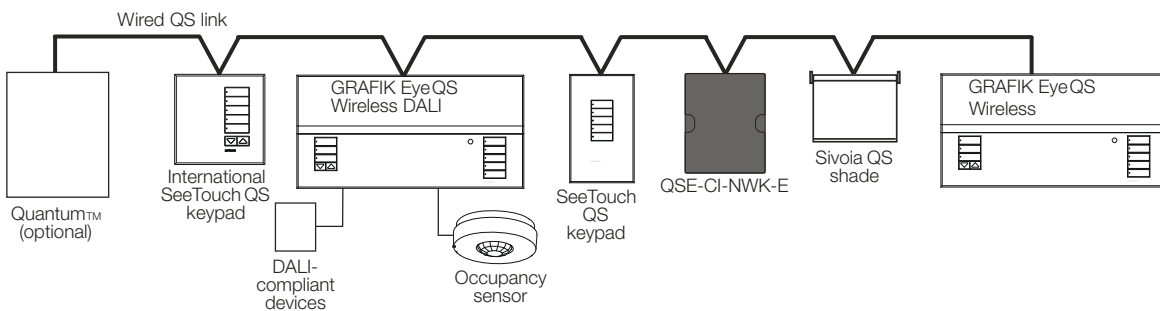

GRAFIK Eye-centric Wireless Example

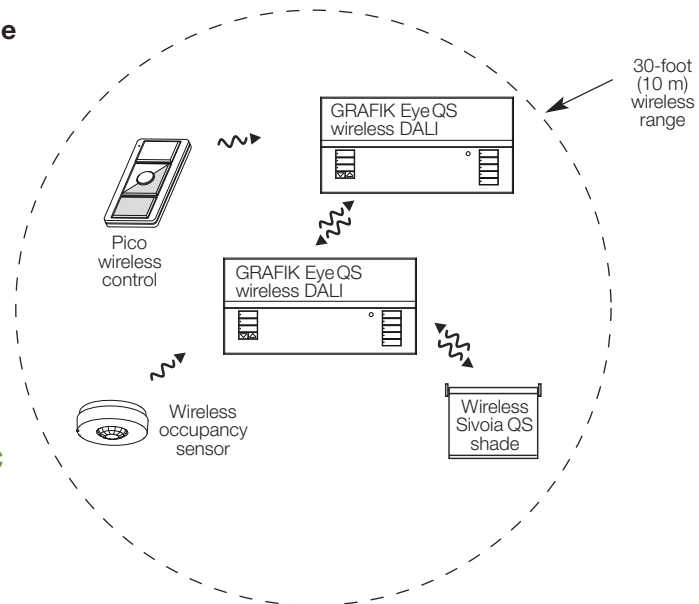

POWER BOOSTER & ELECTRONIC LOW VOLTAGE INTERFACE

Wiring Example

Single-Feed Wiring for PB/ELVI
120V and 220-240V



The PB/ELVI may be on the same circuit as the Control Unit only if the total load does not exceed the rating of the breaker.

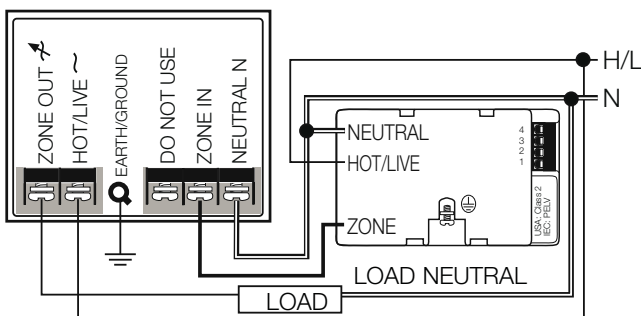

System/Wiring Diagrams

ESN, WALLSTATIONS, SHADES

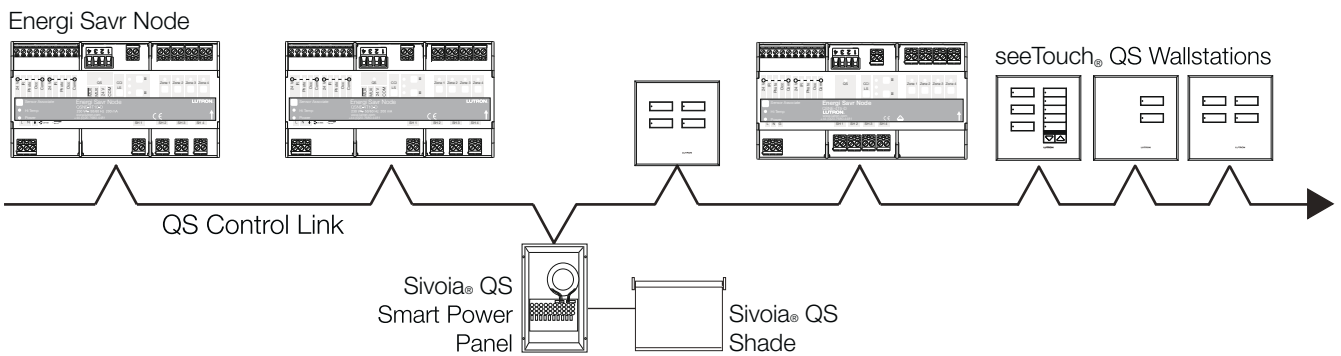

ESN WITH SENSORS AND DALI

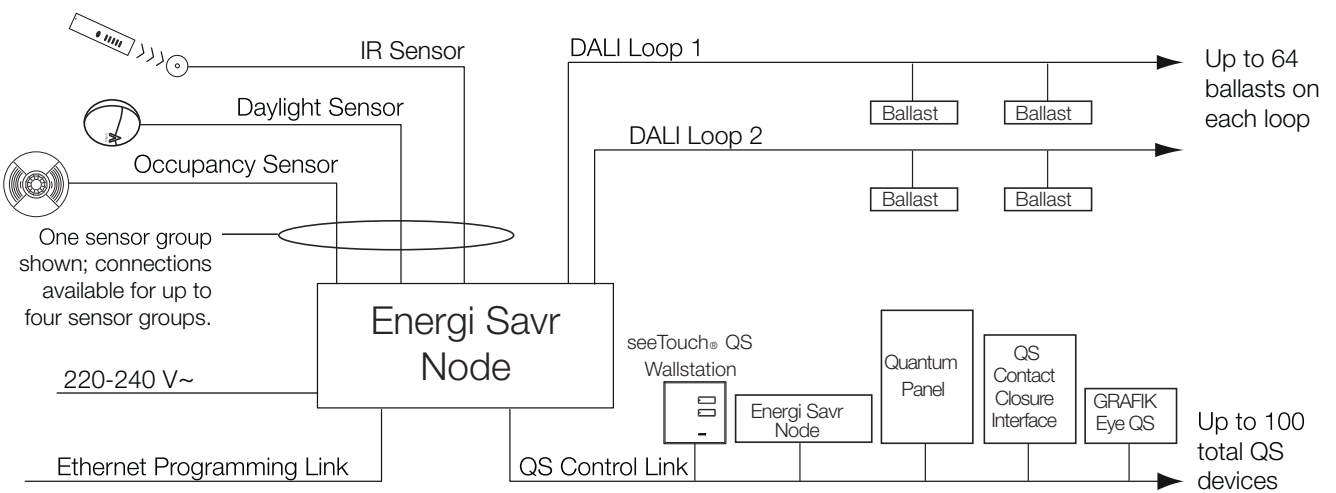

SENSORS

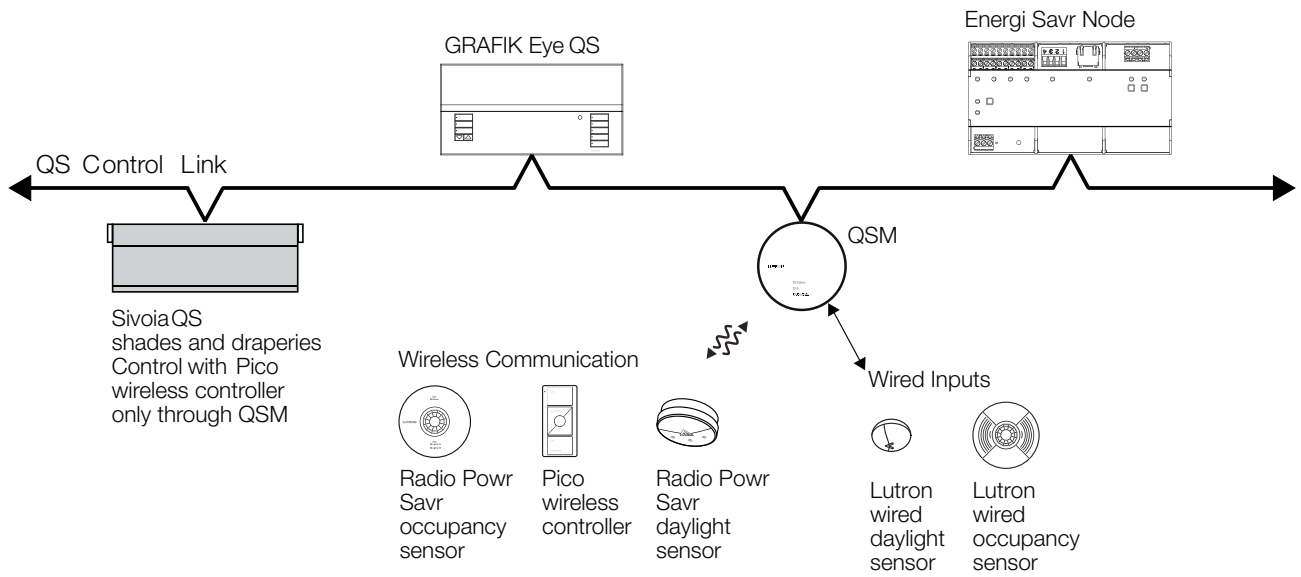

System/Wiring Diagrams

SENSORS

Daisy-Chain Wiring Example (Wired)

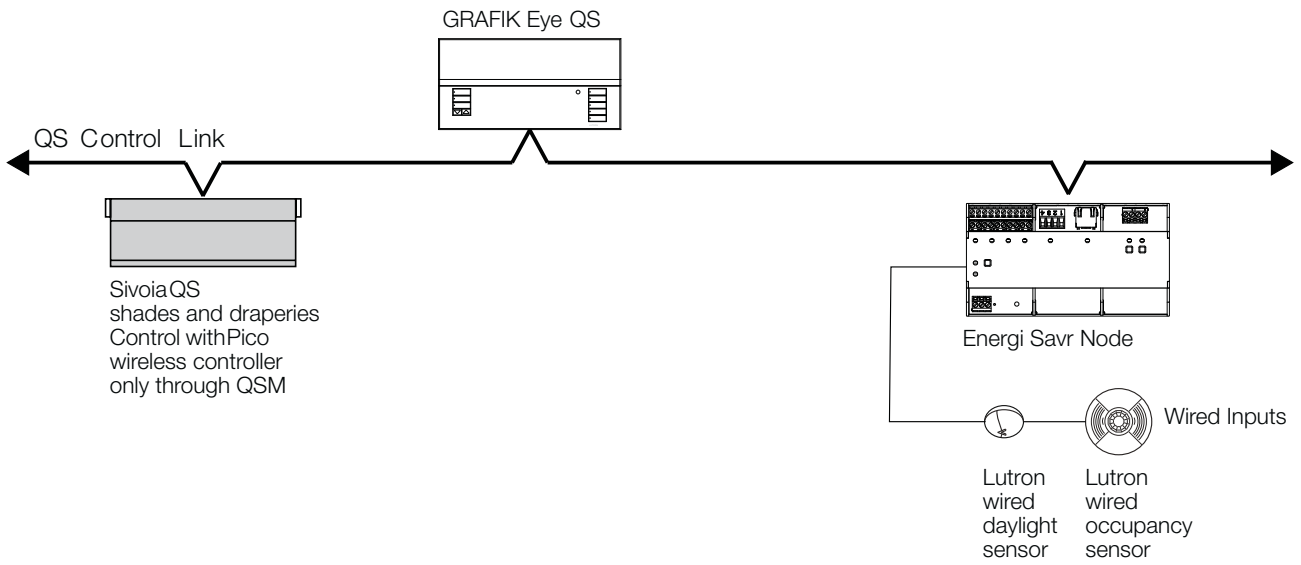

ESN PROGRAMMING INTERFACE

QSE-I0/QSE-CI-DMX/QSE-CI-NWK-E Control Interface Wiring Example

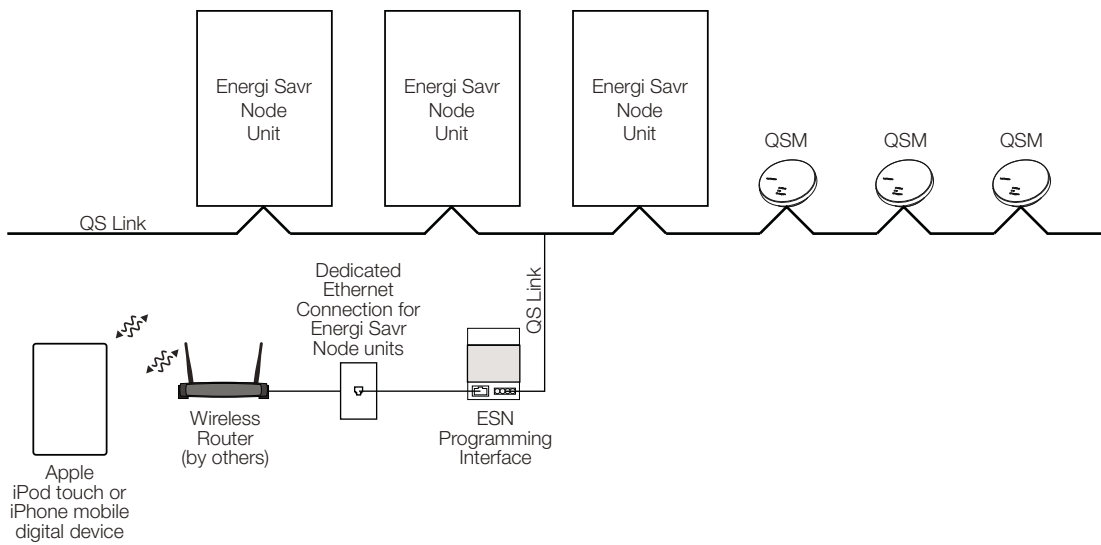

Apple, iPhone, and iPod touch are trademarks of Apple Inc., registered in the U.S. and other countries.

CONTROL INTERFACE

QSE-I0/QSE-CI-DMX/QSE-CI-NWK-E Control Interface Wiring Example

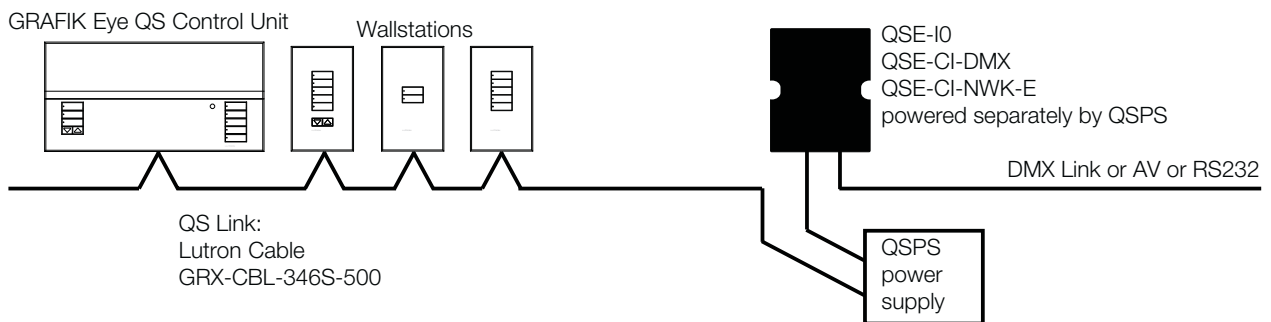

System/Wiring Diagrams

PROCESSOR/SERVER/SOFTWARE/CLIENT LICENCES

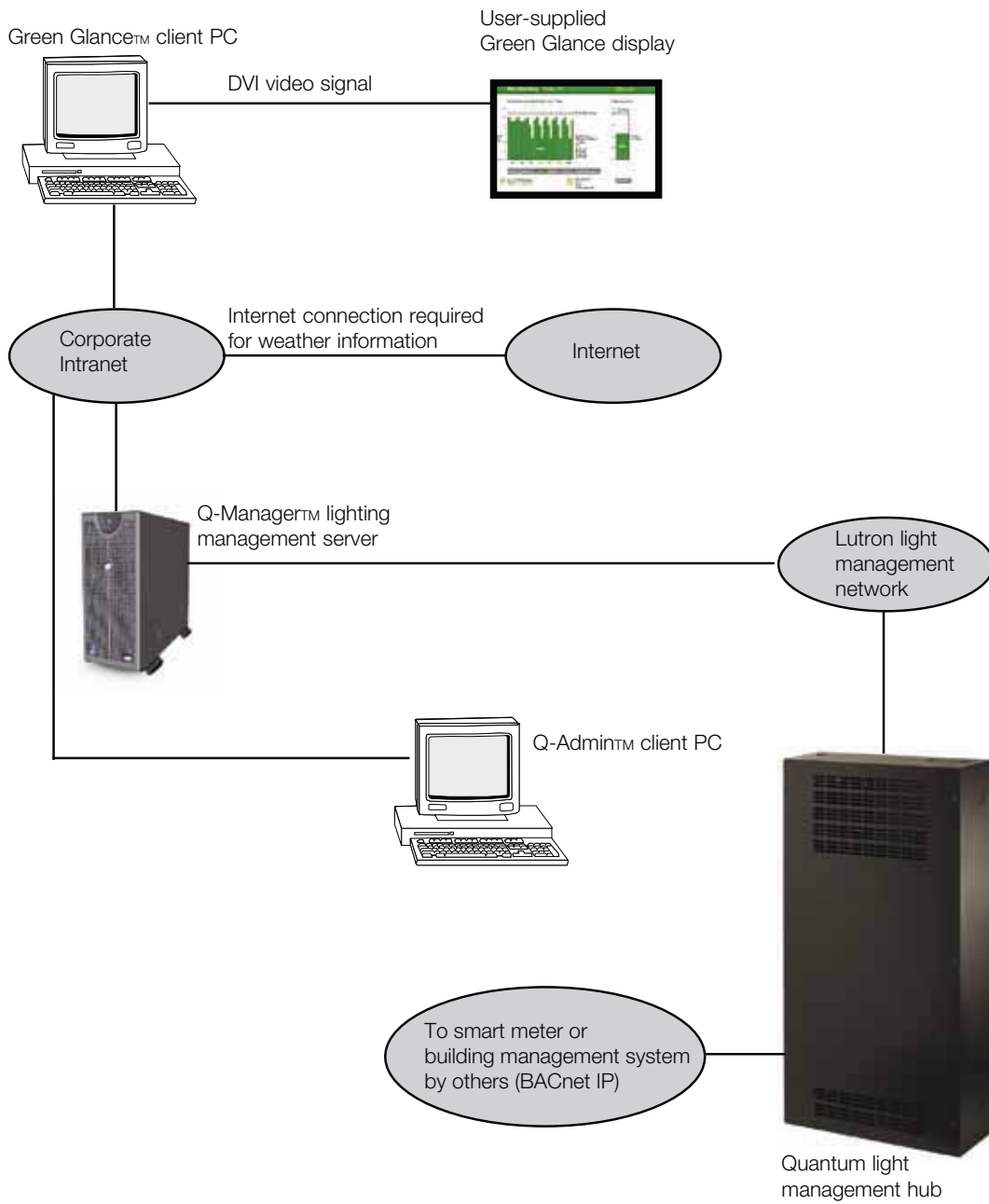

GP DIMMING PANELS – INTERNAL OVERVIEW

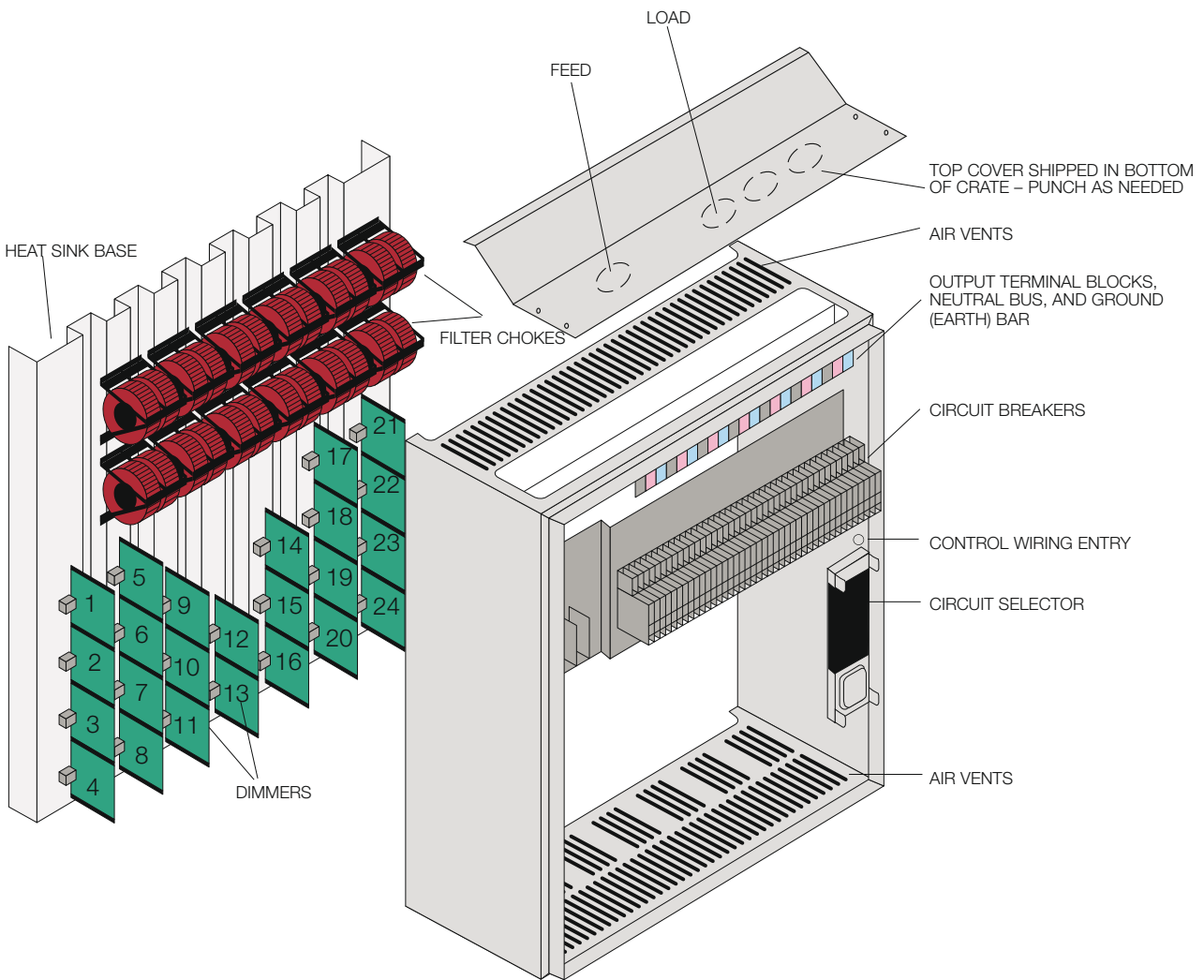

Examples of panel model number

CGP16-230FT-CE-CGP100

CGP: Standard Prefix for custom GP panel
 16: Number of load circuits
 230: Voltage for CE
 FT: Feed Trough
 CE: Region Suffix CE for 230V
 CGP 100 Custom panel Suffix

GP16-2304IS-10CE

GP: Standard Prefix for GP panel
 16: Number of load circuits
 230: Voltage for CE
 4IS: Isolation switch
 10: Number of Amps of branch circuits breaker
 CE: Region Suffix for 230V

System/Wiring Diagrams

LP DIMMING PANELS

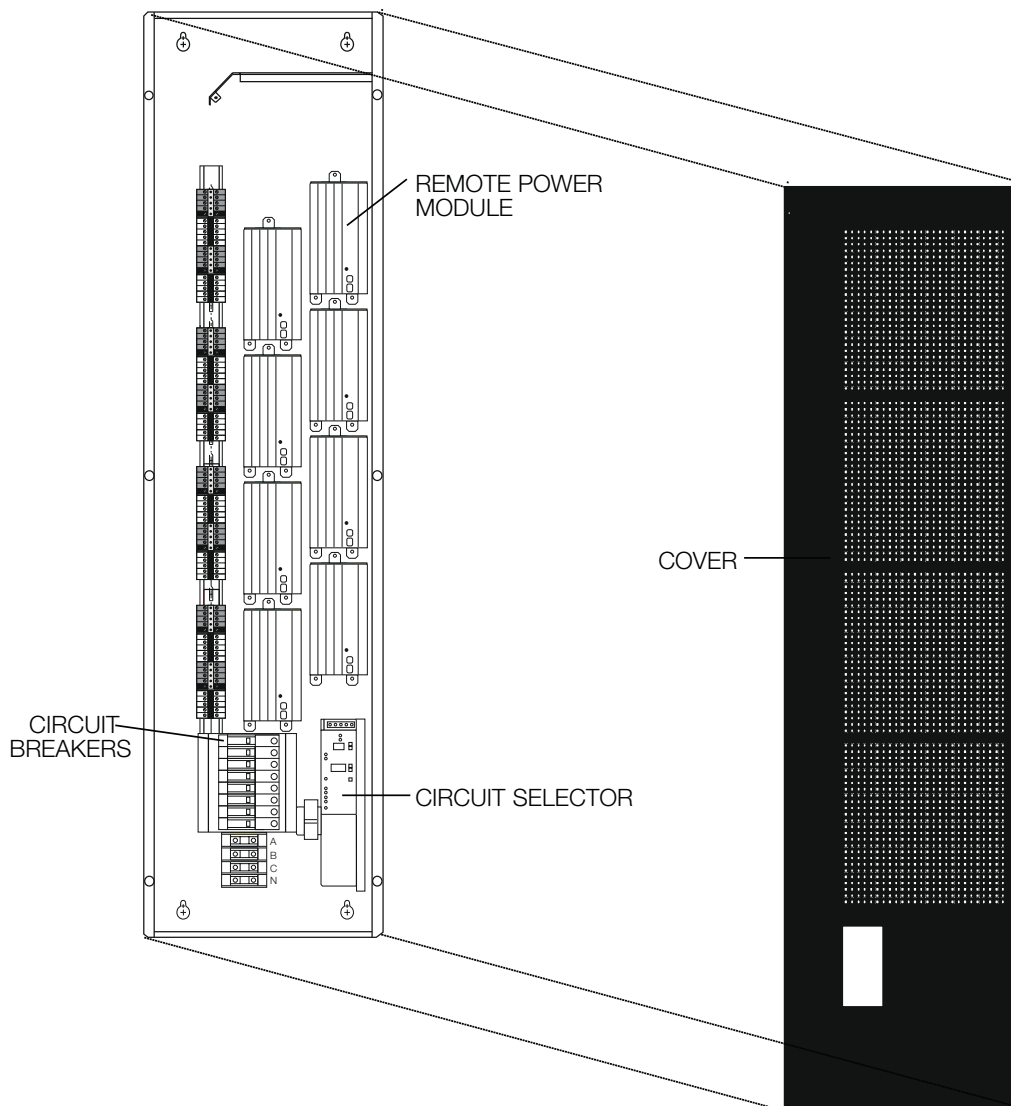

Examples of panel model number

CCP-4X1L1A-230FT-1L

CCP: Standard prefix LP Dimming Panel
 4X: Four Switching Modules
 1L: One LP dimming module
 1A: One Adaptive module
 230: Voltage for CE
 FT: Feed Trough
 1L: One link circuit selector

CCP-2L4A4T-230FTLCP

CCP: Standard prefix LP Dimming Panel
 2L: Two LP Modules
 4A: Four Adaptive Module
 4T: Four TVM module
 230: Voltage for CE
 FT: Feed Trough
 LCP: One LCP programmer

SIVOIA QS – ROLLER 64, 100, 200CW AND 225

**Sivoia QS with GRAFIK Eye® QS System Wiring:
Smart Panel power supply, single shade per output**

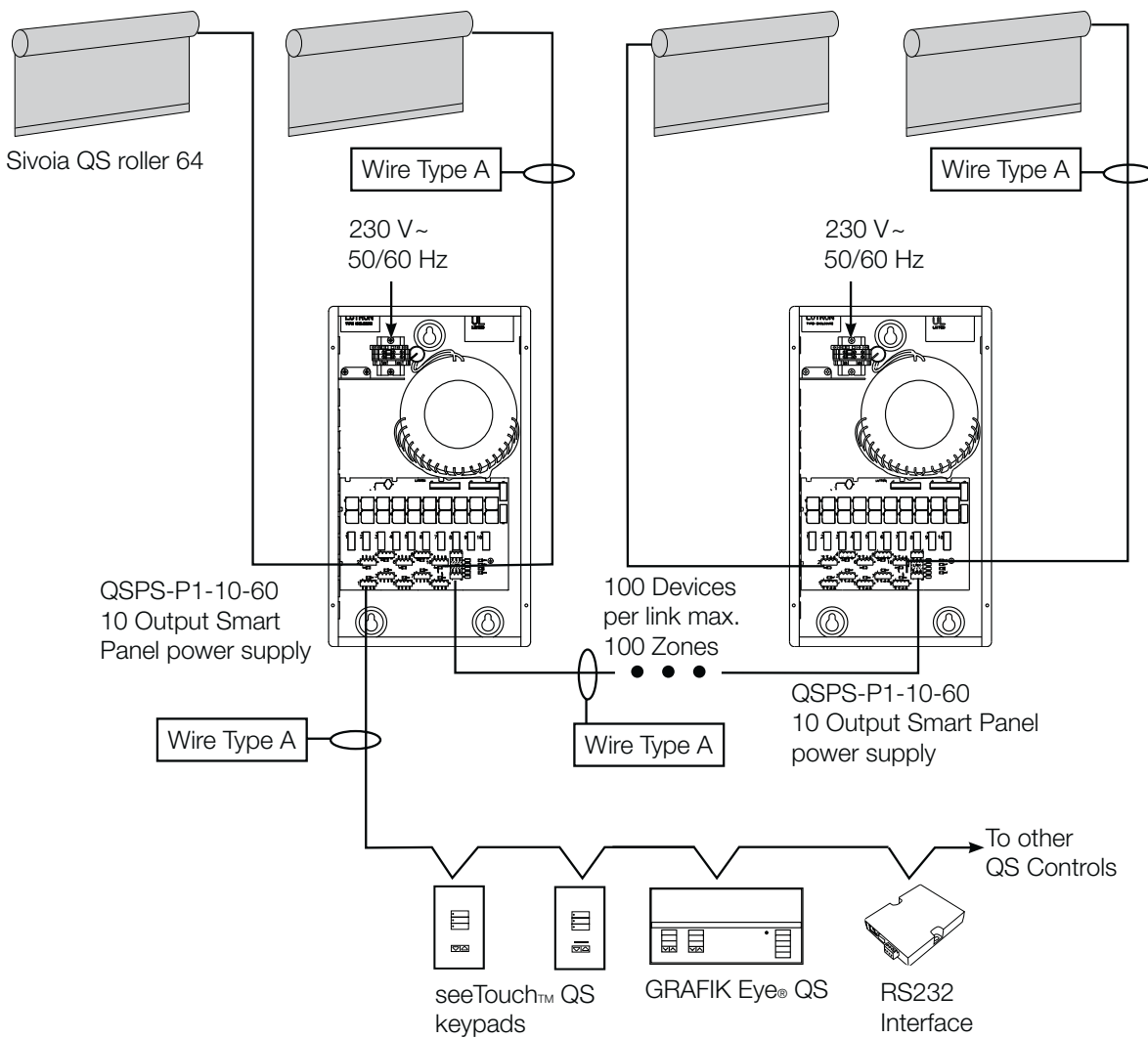

Wiring Type Key

Type A

Communications Link: 4 Conductor (twisted and shielded), listed for application
Maximum comm. link: – Up to 600 m (2000 ft) connecting
all QSPS-P1-10-60 panels

System/Wiring Diagrams

SIVOIA QS SYSTEM WIRING FOR DRAPERY SYSTEM

Sivoia QS System Wiring: Smart Panel power supply, single drapery track per output

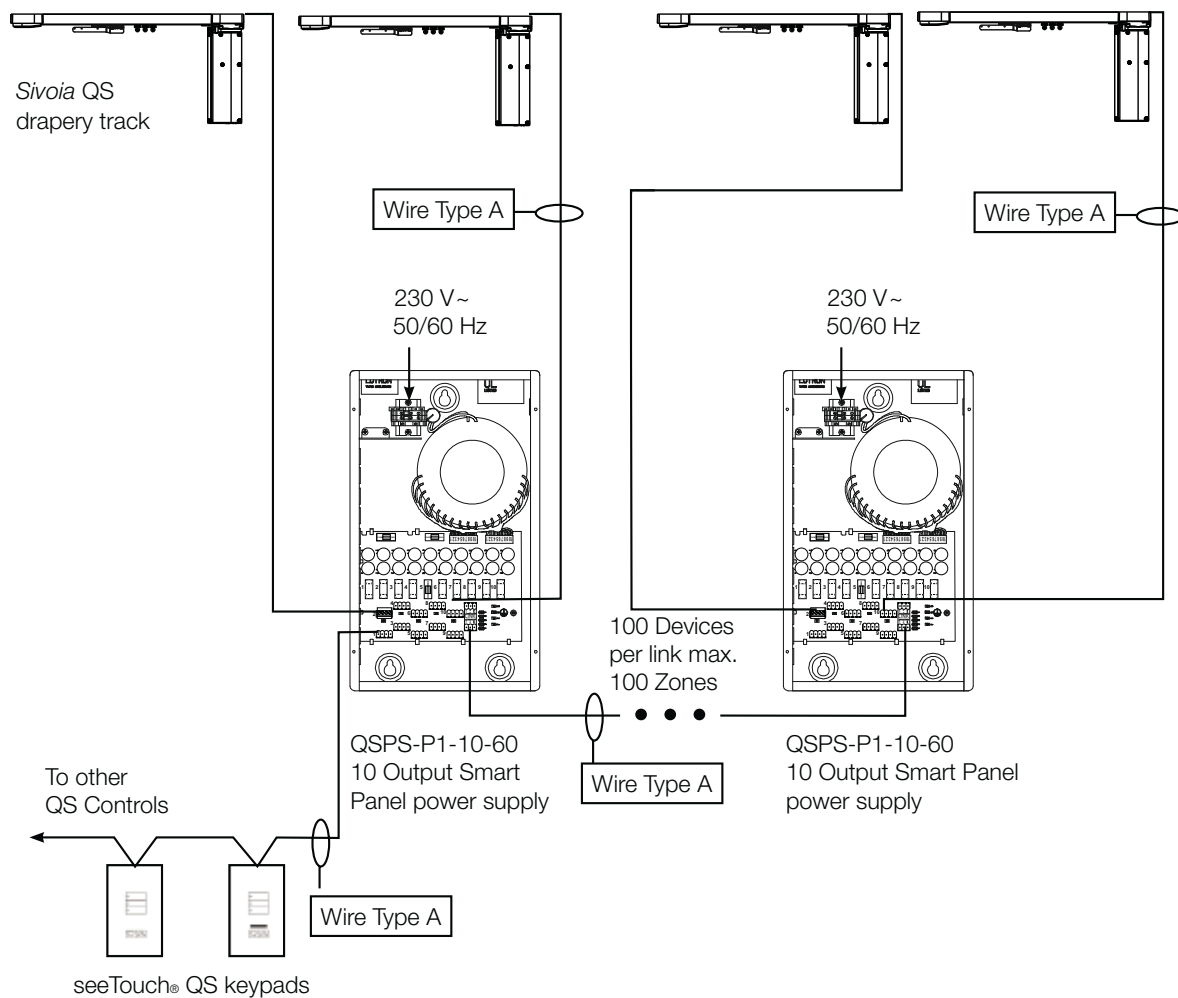

Wiring Type Key

Type A

Communications Link: 4 Conductor (twisted and shielded), listed for application
Maximum comm. link: – Up to 600 m (2000 ft) connecting
all QSPS-P1-10-60 panels

SIVOIA QS – SKYLIGHT SHADE

Sivoia QS System Wiring: Link Power Supply, Single Transformer

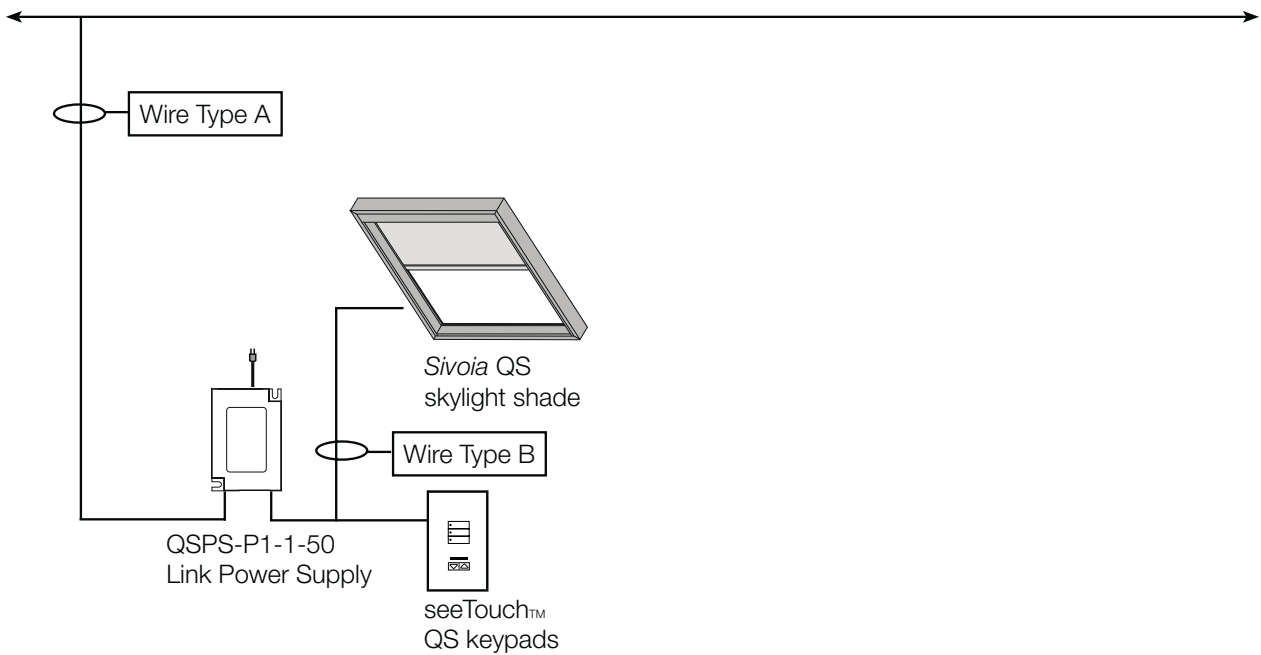

Wiring Type Key

Type A

Communication link (3 Conductor)
Communications used to connect all power supplies
4-0.5 mm² (12-26 AWG) standard, twisted/shielded

Type B

Power and communication link (4 Conductor)
Provides power and communication to QS shades or keypads
4-0.5 mm² (12-26 AWG) standard, twisted/shielded

System/Wiring Diagrams

QS LINK POWER SUPPLY

System Wiring Overview: QS Link power supply

Example: Powering one shade / drapery drive unit
(max of one shade / drapery drive unit per output of a power supply)

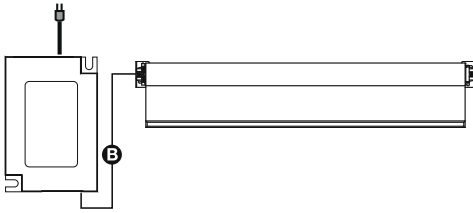

Example: Powering keypads

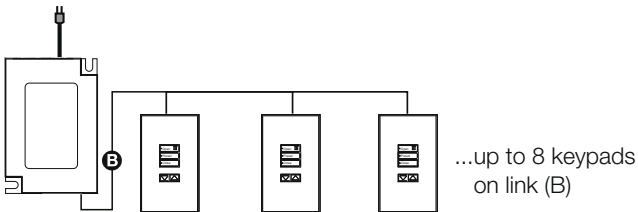

Example: Connecting to a *GRAFIK Eye*® QS (**Note:** *GRAFIK Eye* QS powered from line voltage)

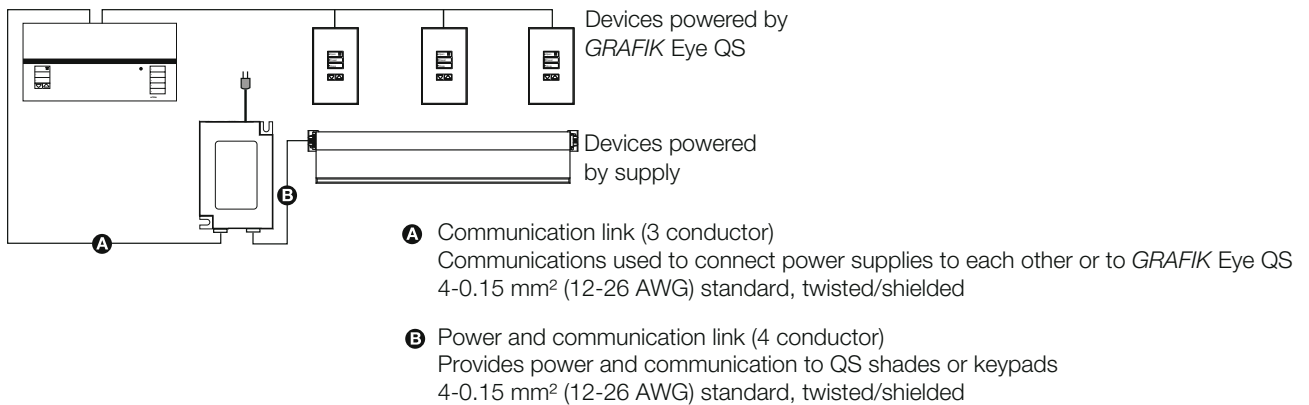

Example: Boarding Room with 6 windows on two different walls, perimeter of the room lit by two circuits of fluorescent lights. Center of the room lit by 1 circuit of LED down-lighters, one AV projector.

Devices	Power Draw Unit Supplied or Output	Power Draw Units or Output Consumed
Controller: Qty:1 <i>GRAFIK Eye</i> QS wireless Dali (QSGRK-6D-WH)	3	N/A
Shade: Qty: 6 Sivoia QS roller 64 of 2.75m ² each.	N/A	3 Outputs
Keypad: 2 keypads (QSWE-8BLRN-)	N/A	2 x 1PDU
Power supply: Qty: 1 Smart panel (QSPS-P2-10-60)	10 outputs, 1 shade + 1 QS Keypad/Output Or 2 Roller 64/Output	N/A
Occupancy Vacancy Sensor: (LRF3-OCRB-P-WH)	N/A	N/A
Day light sensing: Qty: 2 (LRF3-dCRB-WH)	N/A	N/A
Remote control: Qty:1 Hand Held Pico wireless remote control	N/A	N/A
Interface for AV: Qty:1 Contact closure interface (QSE-CI-NWK-E)	N/A	N/A

DIN RAIL QS POWER SUPPLY

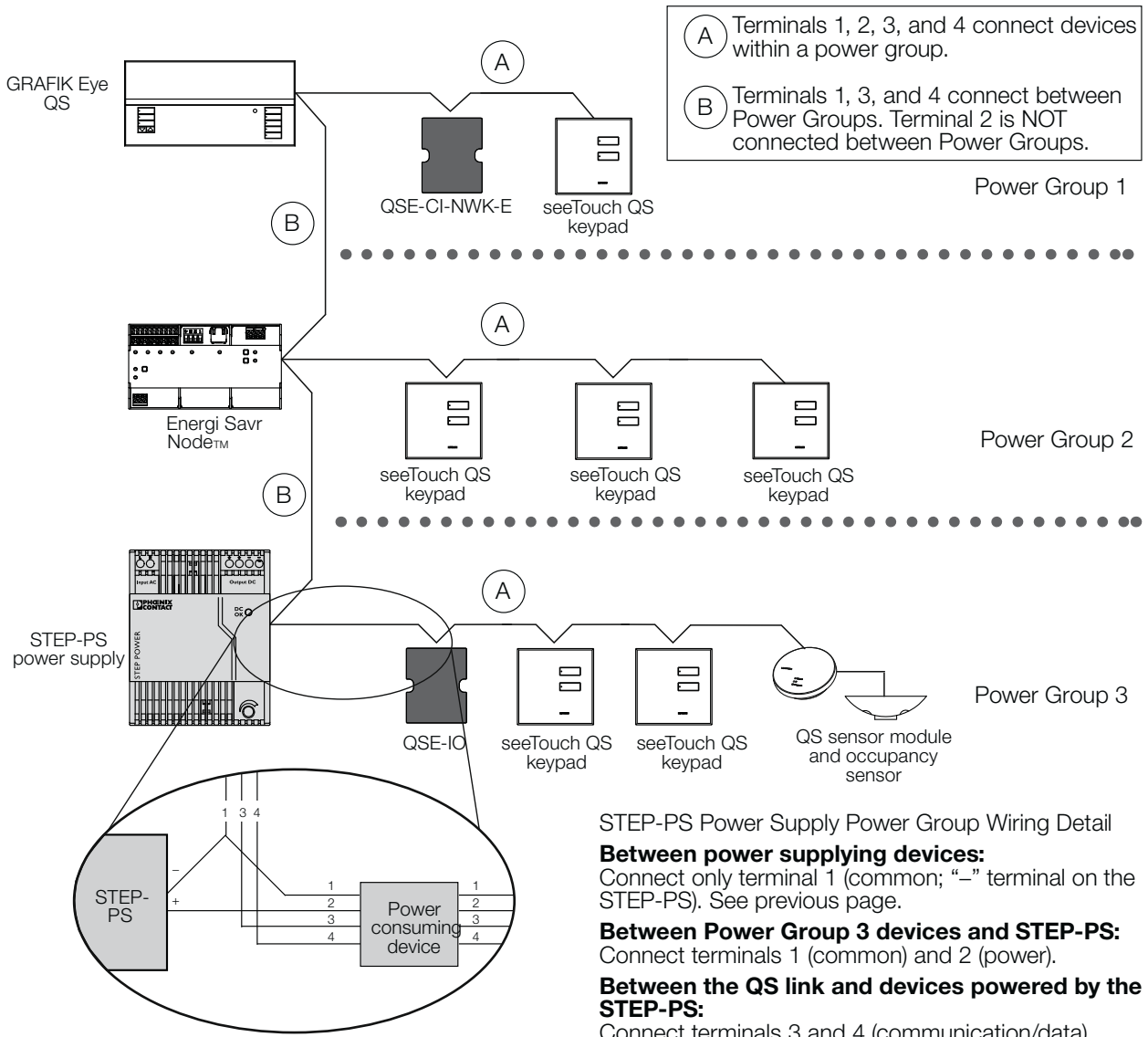

System/Wiring Diagrams

SIVOIA QS – 230V SMART PANEL POWER SUPPLY

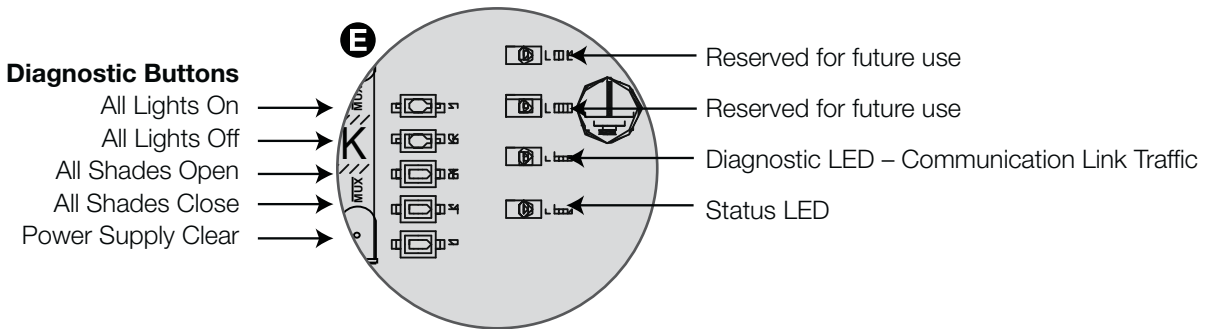
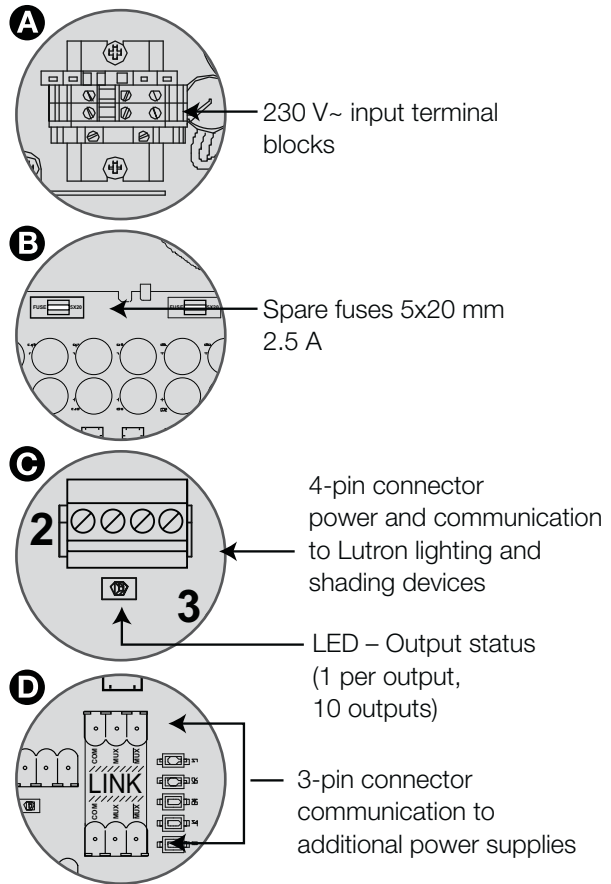
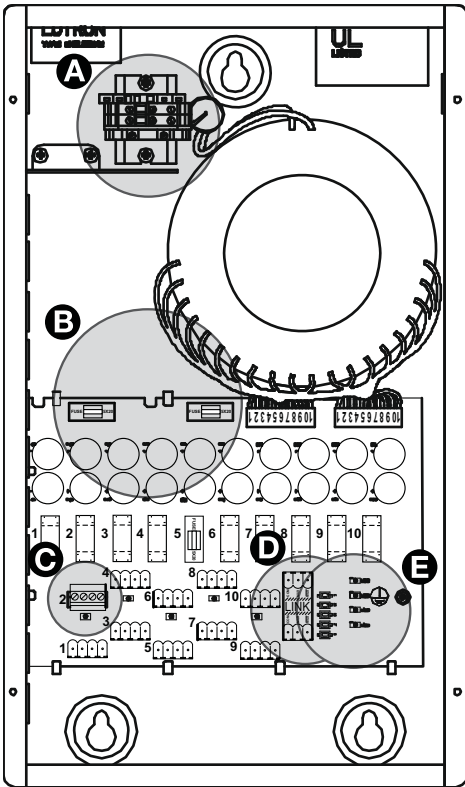

QS Link Limits Table



The table on the following page (58) lists the devices available on the QS link. See the relevant table for each device's count toward the link maximums for zones and devices.

- A QS link can have up to 100 zones (outputs) and 100 devices.
- Each Energi Savr Node unit can supply 14 power draw units















QS link sensor limits:

- 100 wired or wireless occupancy sensors
- 100 wired or wireless daylight sensors
- 100 wired wallstations or Pico (please add registration mark) wireless controllers

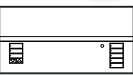
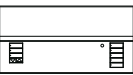
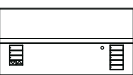
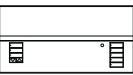
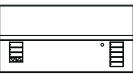
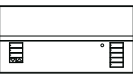
System limits:

- The QS wired communication link is limited to 100 devices (wired or wireless) or 100 zones. Please note the zone count and power unit information in the following table.
- The QS wireless communication link supports up to 30 wireless devices.

QS Link Limits Table

	QS Device Description	Zone Count	Device Count	Power Draw Units (supplied)	Power Draw Units (consumed)
	<i>Energi Savr Node</i> for Switching (QSNE-4S10-D)	4	1	14	0
	<i>Energi Savr Node</i> for 0-10 V (QSNE-4T10-D)	4	1	14	0
	<i>Energi Savr Node</i> for DALI (QSNE-2DAL-D)	up to 32	1	3	0
	<i>Energi Savr Node</i> Programming Interface (QSE-CI-AP-D)	0	1	0	2
	QS Sensor Module (QSM)	0	1	0	3
	Lutron Occupancy Sensor (connected to QS Sensor Module)*	0	0	0	2
	Lutron Daylight Sensor (connected to QS Sensor Module)*	0	0	0	0.5
	Lutron Infrared (IR) Receiver (connected to QS Sensor Module)*	0	0	0	0.5
	3-zone GRAFIK Eye® QS	3	1	3	0
	4-zone GRAFIK Eye QS	4	1	3	0
	6-zone GRAFIK Eye QS	6	1	3	0
	6-zone GRAFIK Eye QS with DALI	6	1	3	0
	8-zone GRAFIK Eye QS with DALI	8	1	3	0
	16-zone GRAFIK Eye QS with DALI	16	1	3	0
	seeTouch® QS	0	1	0	1
	QS contact closure interface (QSE-IO)	up to 5	1	0	3
	QS network interface for audio visual integration (QSE-CI-NWK-E)	0	1	0	2
	DIN Rail power supply (STEP-PS/1AC/24DC/4.2-CPN5550)	0	0	22	0
	QS power supply (QSPS-PX-1-50)	0	0	8	0

*Note: Power draw units are consumed by Occupancy Sensors, Daylight Sensors, and IR Receivers only if connected to the QS Sensor Module (QSM). Power draw calculations are not needed for wireless inputs or wired inputs connected directly to *Energi Savr Node* units.

QS Link Wiring

Wire length chart

Maximum devices per one output		Maximum distance per one output based on wire gauge		
Shades and Controls		4mm ²	1.5mm ²	1mm ² GRX-CBL-346S-500
None	Up to 8 seeTouch QS keypads	350m (1200ft)	150m (500ft)	75m (300ft)
1 Sivoia QS roller 64™, roller 100, roller 200CW, roller 225™ or drapery drive unit	Up to 1 seeTouch QS keypads	150m (500ft)	60m (200ft)	35m (125ft)
2 Sivoia QS roller 64, ≤ 2.75 sq m (30 sq ft) each	None	60m (200ft)	20m (75ft)	15m (50ft)
3 Sivoia QS roller 64, ≤ 1.8 sq m (20 sq ft) each	None			
2 Sivoia QS roller 100, ≤ 4.6 sq m (50 sq ft) each	None			

Where to Find Us



Los Angeles, California

Chicago, Illinois

Toronto

New York City, New York

Coopersburg, Pennsylvania

Worldwide headquarters

Ashland, Virginia

Chihuahua

Plantation, Florida

Puerto Rico

St. Kitts

São Paulo

European headquarters

London

Madrid

Casablanca



● Berlin

● Paris

● Milan

● Barcelona

● Beijing

● Tokyo

● Shanghai

● Dubai, U.A.E.

● New Delhi

● Hong Kong

◎ Singapore
Asian headquarters



Printed on silk paper, comprising of fibres sourced from well managed sustainable forests.

WORLDWIDE HEADQUARTERS

Lutron Electronics Co., Inc.
7200 Suter Road
Coopersburg, PA 18036-1299
USA

Toll-free: 1 888 LUTRON1
TEL: +1 610 282 3800
FAX: +1 610 282 1243
intsales@lutron.com

EUROPEAN HEADQUARTERS

Lutron EA Ltd.
6 Sovereign Close
London, E1W 3JF
UK

FREEPHONE: 0800 282 107
TEL: +44 (0)20 7702 0657
FAX: +44 (0)20 7480 6899
lutronlondon@lutron.com

ASIAN HEADQUARTERS

Lutron GL Ltd.
#07-03 Tower Fifteen
15 Hoe Chiang Road
Singapore 089316

TEL: +65 6220 4666
FAX: +65 6220 4333
lutronsea@lutron.com

INTERNATIONAL OFFICES

Brazil: São Paulo

TEL: +55 11 4327 3800

China: Beijing

TEL: +86 10 5877 1818

China: Hong Kong

TEL: +852 2104 7733

China: Shanghai

TEL: +86 21 6288 1473

France: Paris

TEL: +33 1 56 59 16 64

Germany: Berlin

TEL: +49 (0)30 971045-90

India: Bangalore

TEL: +91 80 4030 0485

India: Mumbai

TEL: +91 22 4070 0867

India: Delhi

TEL: +91 124 471 1900

Italy: Milan

FREEPHONE: 800 979 208

Japan: Minato-ku

TEL: +81 3 5575 8411

Spain: Barcelona

TEL: +34 93 496 57 42

Spain: Madrid

TEL: +34 91 567 84 79

UAE: Dubai

TEL: +971 4 299 1224



www.lutron.com/europe