

TIMEGUARD®

Digital Room Thermostat with Night Set-back

Model: TRT033N



Installation & Operating Instructions

1. General Information

These instructions should be read carefully and retained for further reference and maintenance.

2. Safety

- Before installation or maintenance, ensure the mains supply to the thermostat is switched off and the circuit supply fuses are removed or the circuit breaker turned off.
- It is recommended that a qualified electrician is consulted or used for the installation of this thermostat and install in accordance with the current IEE wiring and Building Regulations.
- Check that the total load on the circuit including when this thermostat is fitted does not exceed the rating of the circuit cable, fuse or circuit breaker.
- To clean use a clean dry cloth only. Do not use any liquid cleaners.

3. Technical Specifications

- 230V AC 50 Hz
- This thermostat is of Class II Construction and must not be earthed
- Switch Rating: 3(1)A
- Switch Type: Single pole, voltage free changeover contacts
- Connection Type: 2 wire
- Installation Type: Surface mount with wall plate
- Micro Disconnection: Type 1.B control action
- Operating Temperature Range: 0°C to +40°C
- Set Temperature Range: 10°C to 30°C
- Temperature Swing Adjuster: +/- 0.5°C or 1.0°C set by DIP switch
- Frost Protection Mode: 5°C
- Night Set Back Mode: Lowers set temperature by 4°C for 1-9 hours
- PID Adjustment: ON or OFF set by DIP switch

- Boiler Type Adjustment: 3CYC = Gas, 6CYC = Oil, set by DIP switch
- Illumination: Blue LED illuminated on setting for button surrounds and display
- Batteries: 2x 1.5V AA
- CE Compliant
- Dimensions (H x W x D): 90 x 95 x 30mm

TRT033N Front View

Digital room temperature display
(illuminated on setting)

Night set-back (reduces temperature
by 4°C, 1-9 hours recall) and frost
protection setting mode

10°C to 30°C
set temperature
range

+/- setting
buttons
(illuminated
on setting)

The heating symbol
will show when heat
is demanded

Flip down cover for display battery
compartment and reset button –
uses 2x 1.5V AA batteries supplied

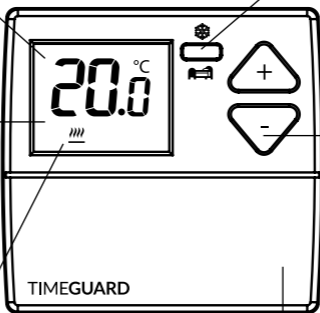

4. Siting

- The TRT033N must be sited where it will not be influenced by heat sources, for example above a radiator or a television or a refrigerator/freezer or in direct sunlight or subjected to draughts.
- The product requires air circulation, so do not position above or below shelving or other wall mounted obstacles.
- It should be mounted approximately 1.5 metres above floor level.

5. Installation

- 5.1 Ensure the mains supply is switched off and the circuit supply fuses are removed or the circuit breaker turned off.
- 5.2 Remove the wall plate from the unit, by undoing the retaining screws, and pivoting the bottom of the unit outwards. The TRT033N body can then be lifted off.
- 5.3 Mark the position of the mounting holes on the wall using the wall plate as a template. Drill out the mounting holes taking care to avoid any joists, electrical cables or water/gas pipes that may be hidden beneath the surface. Insert the rawl plugs into the holes.
- 5.4 Pass the 230V 50Hz mains supply and load cables through the opening of the wall plate. Allow sufficient excess cable to wire up the unit, but not too much to make it difficult to close the unit to the wall plate.
- 5.5 Fix the wall plate to the wall using the correct mounting screws for the rawl plugs installed. The retaining screws which secure the unit to the wall plate should be at the bottom.
- 5.6 Terminate the cables into the terminal block ensuring correct polarity is observed and that all bare conductors are sleeved (See section 6. Connection Diagram). Make sure that the curved washer grips the conductor.
- 5.7 To insert batteries into the unit, first lower hinged flip down cover and carefully lever the battery holder cover off. Insert the 2x AA batteries supplied into the battery holder maintaining the correct polarity, as shown in the base of the battery holder. Re-position the battery holder cover and click into place.

- 5.8 To reinstall the unit onto the wall plate, first ensure the wall plate retaining screws are loosened enough to clear the TRT033N body, then engage the top of the TRT033N onto the wall plate retaining tabs, and push firmly downwards and then upwards. There will be some resistance from the terminals.
- 5.9 Once in place, secure with the retaining screws making sure not to over tighten.

TRT033N Wall Plate

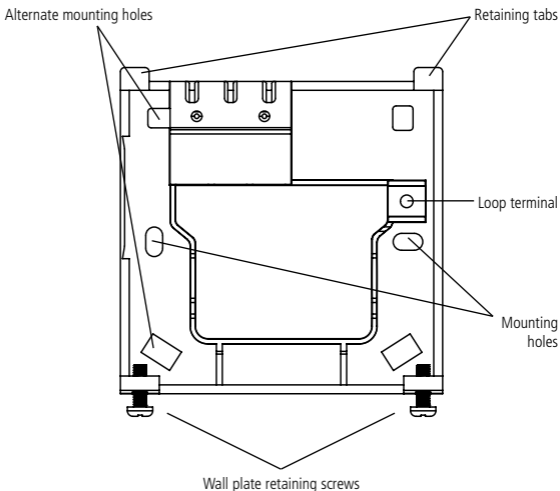

6. Connection Diagram

Connect the 230V 50Hz mains supply and load cables to the terminal block which are marked as follows;

- **Note: Check boiler instructions before connecting.**

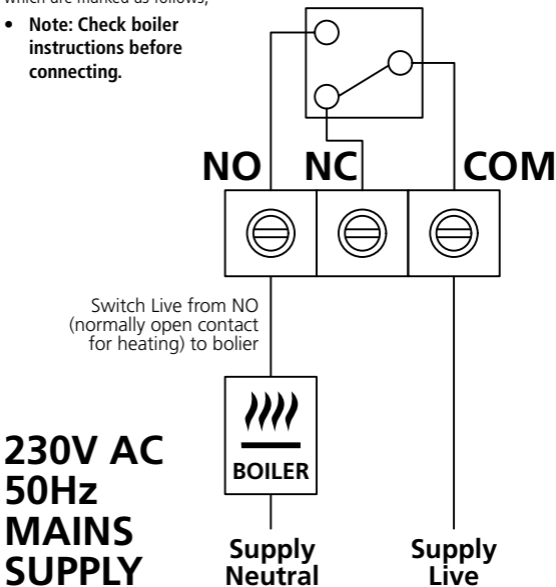

230V 50Hz Mains Supply

Live Supply (Brown or Red) to

L

A 'Loop Terminal' is provided should a 3 core cable be used

Load (Boiler)

Switch Live (Brown or Red) to

NO

7. DIP Switch Settings

- The temperature swing can be adjusted between 0.5°C and 1.0°C by selecting the desired DIP switch position found on the rear of the unit. We suggest using 0.5°C position unless the boiler turns ON and OFF too rapidly. Press the reset button after changing.
- The PID 'Proportional-Integral-Derivative' can also be selected ON or OFF using the DIP switches on the rear of the unit. We suggest setting this to the ON position. As the room temperature approaches the set temperature, the thermostat will intermittently turn the heating ON and OFF, to help prevent temperature over-shoot. Press the reset button after changing.
- The boiler type can be set to either 3CYC (Gas) or 6CYC (Oil), using the DIP switches on the rear of the unit. Press the reset button after changing.

TRT033N Rear of Unit

DIP switch for PID setting DIP switch for boiler type setting DIP switch for temperature swing adjustment setting

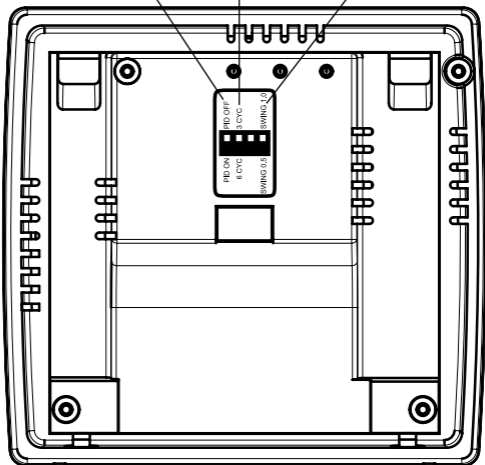

8. Operation

- Restore mains to the unit after making sure to check all system wiring is complete, and after you have selected the desired DIP switch settings.
- Press the reset button located beneath the flip down cover on the front of the unit, all of the characters will briefly appear on the display, followed by the current room temperature.



- The default set temperature is 22°C.

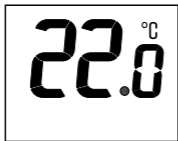

7

Adjusting Set Temperature

- Use the +/- setting buttons to change the set temperature.

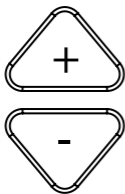

- The set temperature will flash while the change is being made.
- The set temperature change will be made in 0.5 degree increments, and the +/- button surround and display light will illuminate upon setting.
- The set temperature and illumination will time out 5 seconds after the last button press, saving your settings, and the display will revert to show the current room temperature.

- When the room temperature is below the set temperature, the heating symbol will appear on the display to indicate output.

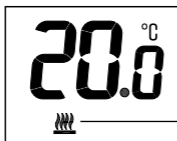

Heating symbol will show when heat is demanded.

Night Set-back Mode

- Press the frost/night set-back button as shown below.



- The display will show 1 hour flashing.

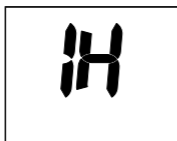

- Use the +/- buttons to set the desired hours, the button surround will illuminate.

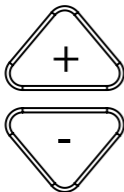

- When the correct number of hours is selected, the display will time out 3 seconds after the last button is pressed. The display will then alternate every 2.5 seconds between the number of hours of night set back remaining, and the current room temperature. The Night set back bed symbol will flash continuously whilst active.



The night set back bed symbol will continuously flash when night set back is active.

- Press the frost/night set back button once again to cancel.



9

Frost Protection Mode

- To enable frost protection mode press and hold the frost/night set back button for 5 seconds.



- The frost symbol will flash once a second in the bottom left hand corner of the display, frost protection mode will now be active.

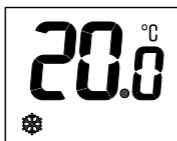

- To disable frost protection mode press and hold the frost/night set back button for five seconds. The frost symbol will cease to flash in the bottom left hand side of the display. From this point on the thermostat will follow the user set target temperature.

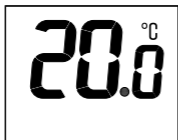

Battery Low Indicator

- When the batteries are low, the battery low indicator comes on.

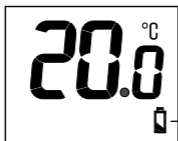

Battery low indicator will appear when the batteries are low.

3 Year Guarantee

In the unlikely event of this product becoming faulty due to defective material or manufacture within 3 years of the date of purchase, please return it to your supplier in the first year with proof of purchase and it will be replaced free of charge. For the second and third years or any difficulty in the first year telephone the helpline on 020 8450 0515.

Note: A proof of purchase is required in all cases. For all eligible replacements (where agreed by Timeguard) the customer is responsible for all shipping/postage charges outside of the UK. All shipping costs are to be paid in advance before a replacement is sent out.

If you experience problems, do not immediately
return the unit to the store.
Telephone the Timeguard Customer Helpline;

HELPLINE
020 8450 0515

or email helpline@timeguard.com

Qualified Customer Support Co-ordinators will be on-line
to assist in resolving your query.



A **theben** Group Company

For a product brochure please contact:

Timeguard Limited.

Victory Park, 400 Edgware Road,
London NW2 6ND

Sales Office: 020 8452 1112
or email csc@timeguard.com

www.timeguard.com