

Thank you for purchasing a BN Thermic product. Manufactured to a high standard this product will, if installed and used according to these instructions, give you years of trouble free performance. Installer: Please ensure instructions remain with your customer for their reference.



**REGISTER:** PLEASE REGISTER THIS PRODUCT ONLINE TO ACTIVATE YOUR GUARANTEE AT  
[www.bnthermic.co.uk](http://www.bnthermic.co.uk)



**IMPORTANT:** PLEASE READ THESE INSTRUCTIONS, NOTE THE SAFE OPERATIONAL REQUIREMENTS, WARNINGS, AND CAUTIONS. USE THIS PRODUCT CORRECTLY, AND WITH CARE FOR THE PURPOSE FOR WHICH IT IS INTENDED. FAILURE TO DO SO MAY CAUSE DAMAGE AND/OR PERSONAL INJURY AND WILL INVALIDATE THE WARRANTY.

## 1. SAFETY INSTRUCTIONS

### 1.1 ELECTRICAL SAFETY

**WARNING!** It is the responsibility of the Installer, owner and operator to read, understand and comply with the following:

- 1.1.1 All electrical wiring must be carried out by a fully qualified electrician in accordance with the current IEE wiring regulations.
- 1.1.2 The installation must be protected by a 30mA RCD for safe operation (not included).
- 1.1.3 The cold lead is 3m long. It can be cut / extended to suit the location of the mains power connection box.
- 1.1.4 Check the continuity and resistance of the floor cable before, during and after installation and record results on back page.

### 1.2 GENERAL SAFETY INSTRUCTIONS

- ✓ The heating cable is intended for use under many floor coverings including: tile, natural stone, slate, porcelain, marble, limestone & terracotta. It can be installed on top of suitably prepared suspended timber floors or solid concrete floors enabling installation in all room types.
- ✓ Always wear rubber sole boots when installing this cable and avoid unnecessary foot traffic over unprotected cable.
- ✓ Ensure no sharp objects come in contact with the cable when installing.
- ✓ All the orange heating cable must be installed in the floor and covered with adhesive and/or self-levelling compound.
- ✓ A minimum clearance of 50mm should be left between the heating cable and perimeter walls.
- ✓ The thermostat floor limit sensor should be located centrally between two cable loops.
- ✓ It is imperative that you never cut, twist or kink the orange heating cable and that two heating coils are never closer than 50mm.
- ✓ Ensure floor is clean, dry and free from sharp objects before laying cable and insulation material.
- ✓ Avoid unnecessary foot traffic over unprotected cable.
- X **DO NOT** install the heating cable on uneven surfaces.
- X **DO NOT** put the cable under permanent fixtures (baths, toilets, fitted cabinets etc).
- X **DO NOT** use screws or nails in places where the heating cable is installed.
- X **DO NOT** shorten the cable. Any attempt to shorten the cable will invalidate your guarantee and put you at risk of dangerous overheating of the floor.
- X **DO NOT** use thick rugs, bean bags, exercise cables, dog beds or other similar items on the heated floor as it may cause localised overheating.
- X **DO NOT** cover any heated part of the floor with walls, solid or permanent floor fixed furniture as this can trap heat and cause local overheating.



## 2. FLOOR INSTRUCTIONS

### 2.1 CONCRETE SUBFLOORS

2.1.1 The insulation level of your subfloor will affect the performance and running costs of your floor heating system. We recommend that you first cover the floor with a layer of our F-Board-6 or F-Board-10 Insulation. This will minimise heat losses, reduce running costs and ensure quicker heat-up times.

### 2.2 WOODEN SUBFLOORS

2.2.1 These should be reinforced and stabilised to provide a rigid base. Ensure the subfloor is clean and free from any sharp objects. We recommend that you first cover the floor with a layer of F-Board-6 or F-Board-10 Insulation. This will minimise heat losses, reduce running costs and ensure quicker heat-up times.

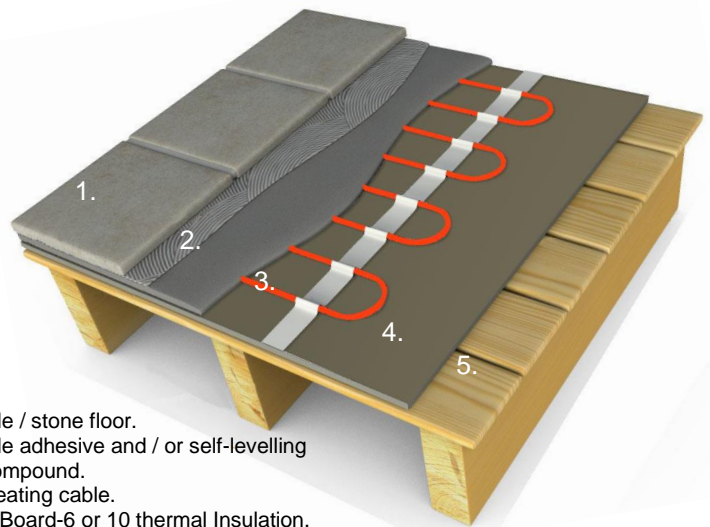

1. Tile / stone floor.
2. Tile adhesive and / or self-levelling compound.
3. Heating cable.
4. F-Board-6 or 10 thermal Insulation.
5. Concrete / timber floor.

## 3. PLANNING

Firstly, calculate the area of the floor to be heated in m<sup>2</sup>. This is usually the total floor area minus the area occupied by permanent fixtures such as shower trays and kitchen cabinets. Now select a cable from the table provided matching the calculated area.

For larger rooms two cables may be required. These should be wired in parallel using a suitable junction box.

The following calculation can be used to estimate the centres of cable loops.

Heated Floor Area (m<sup>2</sup>) ÷ Cable Length (m) x 1000 = Approximate Loop Centres (mm)

e.g. 2m<sup>2</sup> (Heated Floor Area) ÷ 24 (Cable Length) x 1000 = 83.3mm (Approximate Loop Centres)

NOTE:- Do not install the thermostat on an interior bathroom wall.

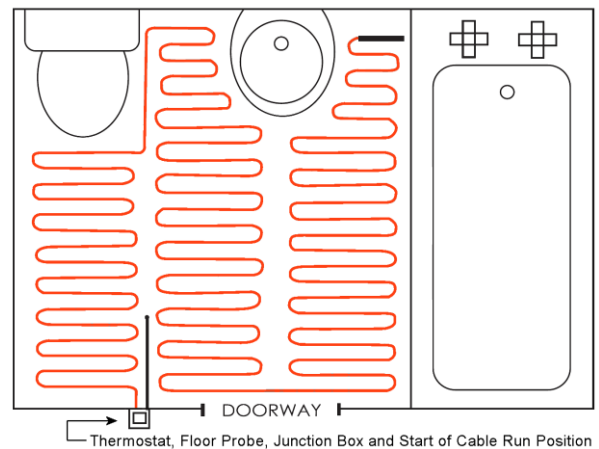

## 4. HEATING CONTROL

**IMPORTANT!** The heating cable **MUST** be controlled by a thermostat with a floor limit sensor.

Choices range from a sophisticated timer / thermostat with touch-screen interface that can be programmed for convenience to a simple manual thermostat with temperature dial adjustment and on/off selection.

With the exception of bathrooms or shower rooms, the thermostat should be installed within the room to be heated and away from draughts.

For bathrooms or shower rooms, the thermostats must be placed outside the room but as close to the installation as possible. Control of the heated floor in this application is provided by the floor sensor only. If using T16CW, T16CS or T16CB model thermostats, a separate remote wall sensor (T16R) can also be purchased and used. These sensors are specifically designed for bathroom type applications.

Refer to the thermostat instructions for installation and technical information.

## 5. LAY THE THERMAL INSULATION

The subfloor should be level and dust free. Suitable thermal insulation boards should be used and laid in a staggered pattern as shown. We recommend our F-Board-6 or F-Board-10. These limit the downward heat loss and significantly reduce the cost of heating your room. Secure the insulation boards using a suitable adhesive following the F-Board Instructions.

## 6. TESTING OF THE HEAT CABLE

It is important to test the resistance of the heating cable using a multi-meter before, during and after installation. These readings should be checked against the label value and recorder on the record sheet on the back page of these instructions.

If there is any variation which is out of the cable tolerance of -5% / +10%, stop immediately and call the technical helpline. When checking the resistance make sure you do not touch the metal probes on the multi-meter otherwise the meter will give you the wrong reading as it is also measuring your internal resistance.

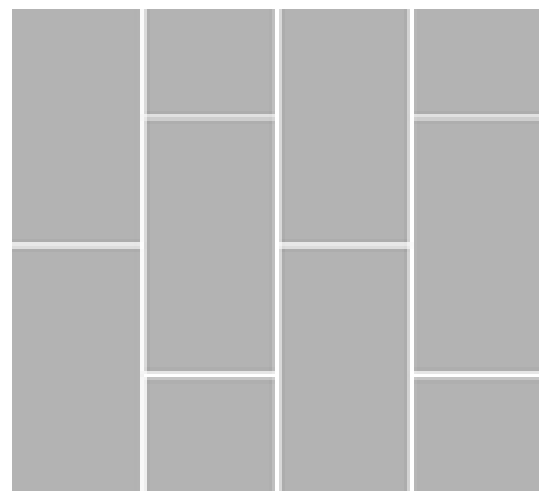
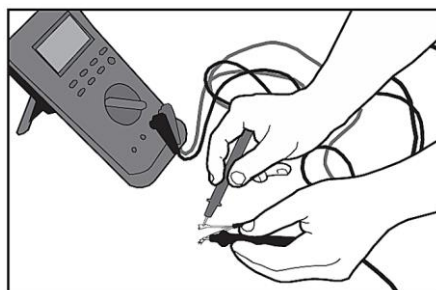

## 7. INSTALLING THE CABLE

### Laying the Cable

The cable should be installed in a neat, evenly spaced grid formation. The centers between loops should not be less than 50mm or greater than 100mm. The radius of the end loops should not be less than 25mm.

There should be a minimum clearance of 50mm from walls or floor-mounted furniture. DO NOT shorten the heating cable length.

Leave a minimum 50mm spacing between cable loops. Do NOT shorten the heating cable length.

### Sticking the cable down

The cable should be secured to the subfloor using the tape provided.

### Using more than one cable

If your floor area is larger than the recommended coverage of the largest cable, it is common practice to install two cables in one room. The cables should be wired in parallel using a suitable junction box. Please ensure that the load rating of the thermostat is not exceeded. Consult your electrician.

### Resistance Test

We recommend that once the cable is stuck to the floor and before using any self-levelling compound or adhesive, a second resistance test is carried out. The result should be recorded on the back page. (Second resistance)

### STANDARD ROOM

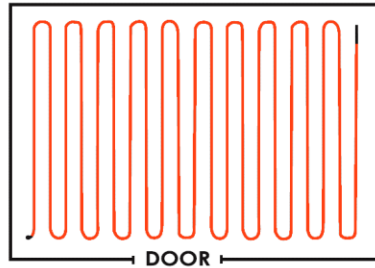

### ROOM WITH CENTRAL OBSTACLE

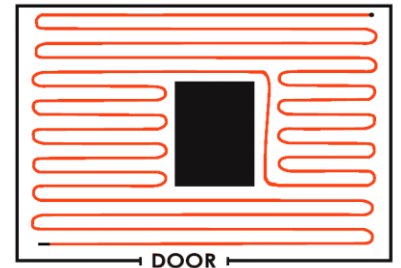

### BATHROOM

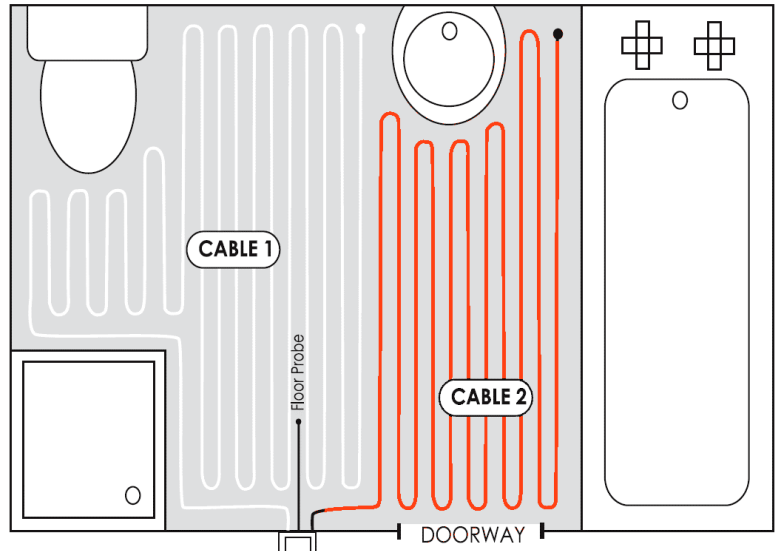
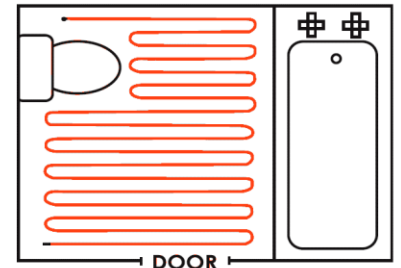

Thermostat Position,  
Junction Box & Start Of Cable Run

## 8. INSTALLING THE FLOOR SENSOR

The floor sensor should be positioned between two orange heating coils in flexible 12mm conduit. The sensor MUST NOT crossover any of the heating cable. The sensor should be positioned a minimum of 350mm from any wall. Seal the end of the conduit with tape to prevent adhesive entering. Ensure that you have sufficient sensor cable to stretch back to your low level junction box and then onto the thermostat. Do NOT cross under any of the heating cables. You will need to create a groove in the floor to recess the conduit below the cable.

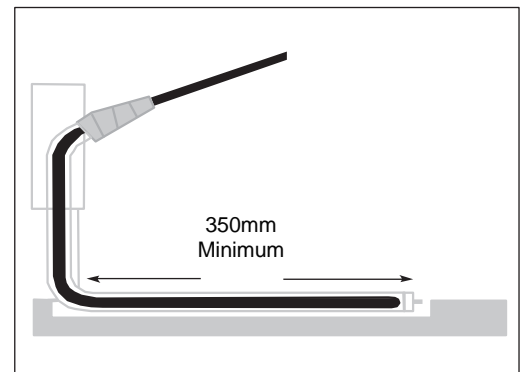

## 9. ELECTRICAL INSTALATION

### Wiring up (Electrician only)

A fully qualified electrician must now make the final connections to the mains supply and install the thermostat.

The electrician should first check for continuity of the floor sensor and retest the resistance of the cable. This reading should be recorded on the record sheet (Third reading). The cable MUST be earthed – connect the braided wire to a suitable Earth connection.

The other two wires are not pole sensitive and one wire should be connected to Neutral and the other to Live. Do NOT power up the heater cable until all the adhesive and grout has completely dried out. This can typically be 14 days BUT consult the manufactures recommendations.

## 10. FIRST SWITCHING ON

Once the adhesive and grout are fully dried the heater cable can be turned on BUT we recommend that for the first week it is run at a reduced temperature bring the system in stages up to the required operating temperature. This is best achieved by adjusting the floor probe set temperature.

## 11. RUNNING

This is achieved by setting the required temperature on the thermostat. After a period of non-use it may take some time for the room to reach temperature. Increasing the set temperature will not speed up the heating process but merely over heat the room once set temperature is achieved. We recommend a maximum floor temperature setting of 28°C for optimum comfort conditions.

## 12. COMPLETE YOUR INSTALATION

Following installation all the technical information on the back page should be fully completed. This should include an additional sketch plan of the cable or cables layout and position of the floor sensor. This together with the purchase receipt and layout sketch should be permanently fixed near the consumer unit.

## 13. TECHNICAL / INSTALATION INFORMATION

Cable Model	Typical Heated Area m <sup>2</sup>	Output (W)	Length (m)	Nominal Resistance (Ohms)	-5% Resistance (Ohms)	+10% Resistance (Ohms)
Standard Cables						
EHC-012	0.7 - 1.0	120	11	440.8	418.8	484.9
EHC-020	1.1 - 1.5	200	19	264.5	251.3	291.0
EHC-025	1.6 - 2.0	250	24	211.6	201.0	232.8
EHC-032	2.1 - 2.5	320	32	165.3	157.0	181.8
EHC-040	2.6 - 2.9	400	37	132.3	125.6	145.5
EHC-045	3.0 - 3.3	450	46	117.6	111.7	129.3
EHC-052	3.4 - 3.8	520	50	101.7	96.6	111.9
EHC-060	3.9 - 4.5	600	64	88.2	83.8	97.0
EHC-075	4.6 - 6.0	750	76	70.5	67.0	77.6
EHC-095	6.1 - 7.5	950	87	55.7	52.9	61.3
EHC-110	7.6 - 8.5	1100	115	48.1	45.7	52.9
EHC-130	8.6 - 10.0	1300	131	40.7	38.7	44.8
EHC-170	10.1 - 13.0	1700	159	31.1	29.6	34.2
EHC-200	13.1 - 15.5	2000	194	26.5	25.1	29.1

Installer - Please fill in the details for each cable you install and leave a separate drawing showing instalation layout and position of the floor sensor						
Cable Model	Example EHC-060					
Date first resistance taken	06-01-2020					
First resistance	84.4 Ω	Ω	Ω	Ω	Ω	Ω
Date second resistance taken	08-01-2020					
Second resistance	84.5 Ω	Ω	Ω	Ω	Ω	Ω
Electrical Instalation date	15-01-2020					
Third resistance	84.4 Ω	Ω	Ω	Ω	Ω	Ω
Insulation Resistance	8.5 MΩ	MΩ	MΩ	MΩ	MΩ	MΩ



This product conforms to EU Directive 2002/96/EC.

This appliance bears the symbol of the crossed waste bin. This indicates that, at the end of its useful life, it must not be disposed of as domestic waste, but must be taken to a collection centre for waste electrical and electronic equipment. It is the user's responsibility to dispose of this appliance through the appropriate channels. Failure to do so may incur penalties established by laws governing waste disposal.

**NOTE:** It is our policy to continually improve products and as such we reserve the right to alter data, specifications and component parts without prior notice.

**IMPORTANT:** No liability is accepted for incorrect use of this product.

**WARRANTY:** Your BN Thermic product correctly installed is guaranteed for life as long as it is registered within 30 days of purchase (see below). In the unlikely event of malfunction resulting from faulty manufacture. The Guarantee covers the full purchase price but not the cost of repairing or replacing the heater cable in the floor. Control devices carry the manufacturers 1 year warranty only. This guarantee in no way prejudices your rights under common law and is offered as an addition to consumer liability rights.

**REGISTER:** Activate your warranty by registering online at [www.bnthermic.co.uk](http://www.bnthermic.co.uk) and retain this data and Installation plan for future reference.

BN Thermic Ltd,  
34 Stephenson Way, Crawley,  
RH10 1TN  
Tel: +44 (0) 1293 547361  
Email: [sales@bnthermic.co.uk](mailto:sales@bnthermic.co.uk)  
Web: [www.bnthermic.co.uk](http://www.bnthermic.co.uk)

EHCINS-v02