

PRODUCT CATALOGUE

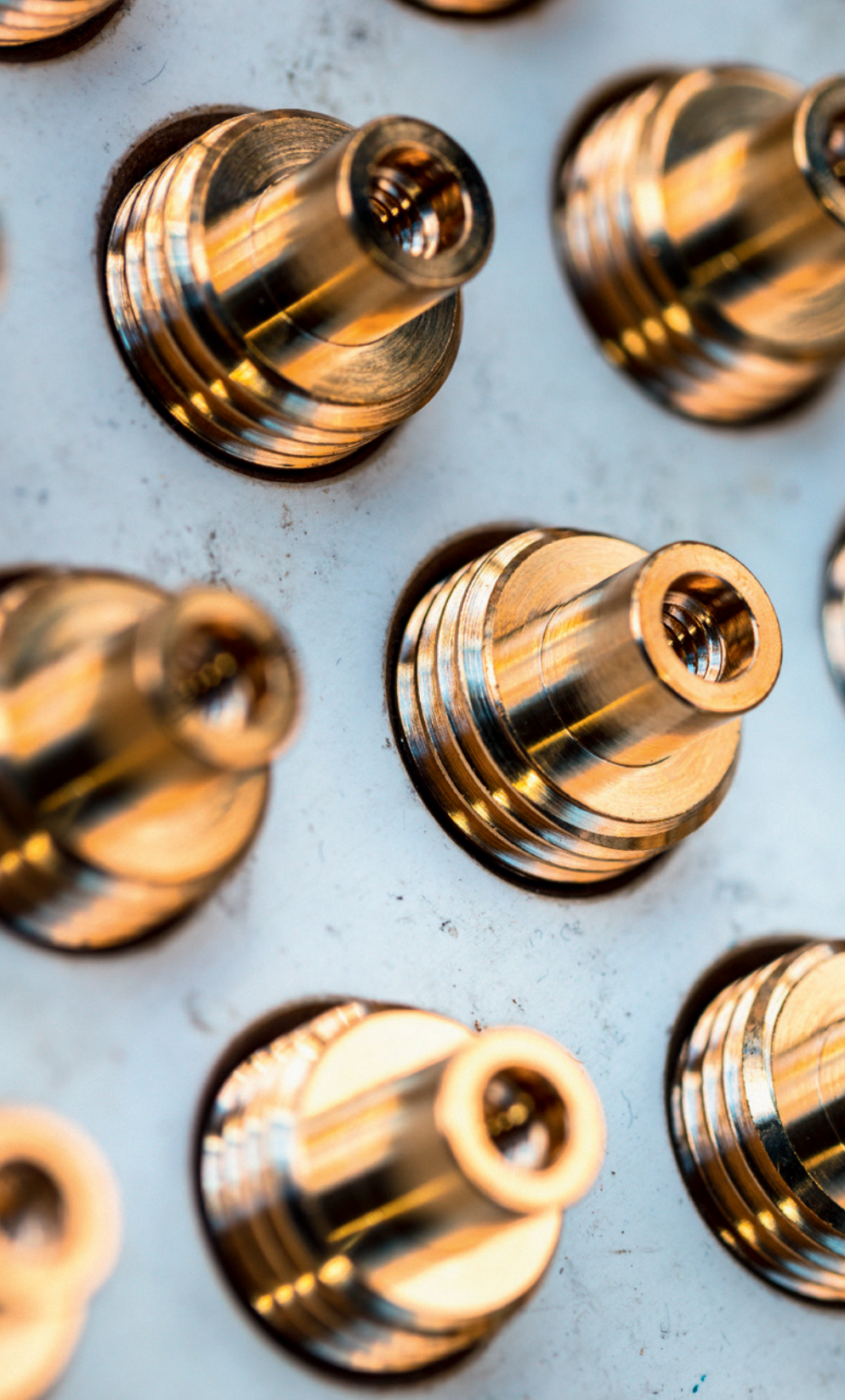

SPIROTOP®

SPIROVENT®

SPIROTRAP®

SPIROCOMBI®

SPIROCROSS®

SPIROPRESS®

SPIROPURE®

SPIROPLUS®

SPIROCARE®

ACCESSORIES



Introduction	4
Product group overview	18
Application	20
SpiroLife Exceptional guarantee	22
Navigation guide	23
SpiroTop Automatic air vents	33
SpiroVent Microbubble deaerators	37
SpiroTop Solar / SpiroVent Solar Automatic air vents and deaerators for solar installations	45
SpiroVent Superior Vacuum degassers	49
SpiroTrap Particle and dirt separators	55
SpiroCombi Deaerators and dirt separators	63
SpiroCross Hydraulic deaerators and dirt separators	71
SpiroPress Vacuum degassing and pressurisation	77
SpiroPure Deminerlization	93
SpiroPlus Flushing agents and additives	95
SpiroCare Analysis and advice	99
Others Accessories, useful information	101
Contact	108

Fluid conditioning – the pressure is rising for planners and plant manufacturers!

The development of technical solutions for heating and cooling systems is progressing faster and faster, thus mounting the pressure on planners and plant manufacturers.





The results of these developments are consistently positive for investors, operators and owners, and lead to heating and cooling systems and their components becoming more and more efficient, effective and powerful. This conserves valuable resources, increases efficiency, saves a lot of energy and ultimately reduces the operating and energy procurement costs. However, this also means that the tasks for you as a planner, plant manufacturer or engineer are becoming increasingly complex at the same time.

As with a racing car, all components have to be optimally selected so that the full potential of the entire system is realised, and you can reap the rewards of your investment.

It is therefore clear that detailed and systematic planning and consideration of all components – including the heating or cooling water – as well as all influencing factors, whether from a mechanical, physical or chemical point of view, are now more important than ever before.

Each system is only as good as its weakest component

Heat boilers, heat pumps, cooling units, high efficiency pumps, hydraulic valves and heat exchangers are now highly optimised in terms of efficiency, and already seem to be at the pinnacle of their performance.





In the case of modern pumps, for example, this is achieved by means of smaller clearances, whereas, for a better hydraulic alignment, control valves are now used which only have minimal openings.

It is easy to imagine that the quality and composition of heating or cooling water as a medium of heat transfer can influence the efficient and, above all, trouble-free operation of heating and cooling systems in a way that is often underestimated.

Today, each and every component of the system has an important function, and the weakest link in the chain defines the overall quality. This is a valid reason for paying close attention to the often underestimated and unloved system fluid and its optimal conditioning. This is good news for operators, owners, controllers and service staff!

The system fluid – the lifeblood of every heating and cooling system



If we were to attempt to make an anatomical comparison, we could consider heating and cooling generators, the pumps and valves in heating and cooling systems, as the central and vital body organs, such as the heart and lungs, and the system fluid as the blood.

As the condition of blood in the human body is of key importance for all organs to work efficiently and to survive the elements of everyday life, so is the fluid in a HVAC system. When the blood is in good condition, the organs can work and the whole organism is capable of surviving. The same is true when it comes to HVAC systems. The moment the quality of the system water fails to meet the standards and guidelines, significant errors, serious damage and loss of efficiency may occur. This may lead to legal or regulatory implications and can have a negative effect on warranty, operational costs as well as repair and maintenance costs.

Corrosion is just one of many consequences of inadequate water conditioning



A microscopic image showing a surface with a complex, porous structure. The surface is primarily reddish-brown with numerous irregular, blue-green deposits scattered across it. These deposits vary in size and shape, some appearing as small, rounded particles and others as larger, more irregular clumps. The overall appearance is that of a heavily textured and possibly corroded or fouled surface.

There are numerous factors that pose negative effects on inadequately conditioned system fluid.

Chemical processes, deposits, particles or air in the system fluid, can all influence the functionality of individual components and also the effectiveness of the entire system. They can lead to serious damage in individual vital parts, to an incorrect pH value, which provokes corrosion on metallic materials, up to microbiological film formation and the resulting clogging of small cross-sections in the heating or cooling system.

The system really does not reveal its full power until everything is coordinated. When there is constant pressure in the system, when there is a consistent absence of air pockets, when particles such as magnetite are automatically removed from the system, when the pH value is correct, you will get consistent high performance and economic value from your installation.

System breakdown due to a heating obstruction

Even with the best system water, unpleasant effects such as corrosion and the resulting corrosion particles in the system water of heating, cooling and processing systems cannot be completely prevented.



The risk of contamination of plant water is commonly underestimated or overseen completely by planners and operators because the corrosive particles such as magnetite and other dirt generated in the system are often so small that they cannot be seen with the naked eye. Initially, even systems designed without a dirt separator such as the SpiroTrap, work smoothly. However, in the medium to long term, the continuous deposition of particles and dirt on system-sensitive components such as heat exchangers, pumps, valves and throttle valves causes serious problems. In addition to significantly increased energy consumption, this leads to the impairment of important functions and to recurring faults, combined with the need for additional maintenance and economic consequences for the operator. In the end, it can even lead to a heating obstruction – that is, the failure of the entire system.

SPIROTECH SOLUTIONS FOR DIRT SEPARATION

Spirotech offers a comprehensive range of SpiroTrap dirt separators – from small brass models for all residential dwellings, to extremely robust and powerful steel models for large-scale industrial use. With the SpiroTrap MB3/MBL and SpiroTrap Magnet series, Spirotech also has extremely powerful dirt separators with unique magnetic technology. They guarantee fast and optimal magnetite and dirt separation.

Beside non-magnetic particles, even the smallest magnetite particles are removed, maximising system performance and protecting costly system components. Thanks to the smart design, collected dirt can be removed quickly and easily during operation. In addition, with the SpiroCombi, Spirotech offers a hybrid variant which simultaneously separates air and dirt.



SPIROTRAP® MB3



SPIROTRAP® MAGNET

From circulation problems to a blockage

There are many possibilities for air to enter the system water in heating, cooling and processing systems. In part, depending on the pressure and temperature in the system, air is already present in water.

Air in the system is frequently responsible for costly and high-maintenance failures. It causes loud noises in radiators, heat exchangers, pipes and pumps. It makes it extremely difficult to adjust systems, and promotes corrosion and thus the formation of dirt and magnetite. Air in the system leads to a significant reduction in heating and cooling performance, and premature wear and tear on major system components, or, much worse: a blockage. This, in turn, could lead to the complete failure of the system, with all the hassle that comes with it, such as dissatisfied tenants, operators or investors. It is therefore predictable what will happen in the medium to long term if a system is designed and operated without individual solutions for air removal, such as the SpiroTop automatic air vent, the SpiroVent microbubble deaerator and the SpiroVent Superior vacuum degasser.



SPIROTECH SOLUTIONS FOR AIR REMOVAL

Spirotech offers a comprehensive portfolio of consulting, solutions and services for three different types of air inclusion in heating, cooling and processing systems. The SpiroTop automatic air vent series is ideal for removing free air from the system. For separating and removing micro-bubbles from process fluid, Spirotech offers its customers the SpiroVent series. And for releasing, separating and removing free air, trapped air and even dissolved air, from the process fluid, there is the SpiroVent Superior vacuum degasser.



SPIROTOP®



SPIROVENT®



SPIROVENT® SUPERIOR

Heating rhythm disturbances and pressure fluctuations

It is undisputed that many of the problems with heating and ventilation systems are caused by poor pressure retention. This can lead to a number of serious consequences.



Whether a heating, cooling or processing system is being built from scratch or it is being refurbished, the right design, installation and maintenance are decisive for an efficient and economical operation. Poorly designed or serviced pressure maintenance inevitably leads to higher operating costs: It must be constantly fed in, which leads to air problems and a higher rate of system wear (cavitation on pumps).

Maximum performance is achieved exclusively via tailor-made solutions that integrate both vacuum degassing and pressure maintenance, such as the SpiroPress series. This is the only way to avoid heating rhythm disturbances and pressure fluctuations.

SPIROTECH SOLUTIONS, COMBINING PRESSURE MAINTENANCE AND VACUUM DEGASSING

The SpiroPress series covers a full range of solutions, for the most basic setup to the most extended, complicated system. SpiroPress is tailored to all requirements and dimensions from XS to XXL in different product lines. The additional water required in the system is degassed in the SpiroPress series prior to system entry, offering the system substantial long-term protection – not only during adjustment but during the entire operating period of the system. SpiroPress can dramatically increase system performance. The premature failure of important system components can thus be avoided. Extended with dirt separation and degassing, the system functions just as operators and users wish.



SPIROPRESS®



**SPIROPRESS®
MULTICONTROL**

Product group overview

Page 33

SPIROTOP®



BRASS



HIGH TEMPERATURE



HIGH PRESSURE



STAINLESS STEEL

Page 10

SPIROVENT®

(The hi-flow solutions are available both in a flange design and a weldable version.)



BRASS HORIZONTAL



BRASS HORIZONTAL

Page 27

SPIROCOMBI®

(The hi-flow solutions and demountable solutions are available both in a flange design and a weldable version.)



SPIROCOMBI MB3



STEEL FLANGE DESIGN



MAGNET FLANGE DESIGN



DEMOUNTABLE FLANGE DESIGN



HI-FLOW DEMOUNTABLE FLANGE DESIGN



STEEL WELD ENDS



MAGNET WELD ENDS



DEMOUNTABLE WELD ENDS

SPIROTRAP®

(The hi-flow solutions and demountable solutions are available both in a flange design and a weldable version.)



BRASS HORIZONTAL



SPIROTRAP MB3



STEEL FLANGE DESIGN



MAGNET FLANGE DESIGN



BRASS VERTICAL



SPIROTRAP MBL



STEEL WELD ENDS



MAGNET WELD ENDS

SPIROCROSS®



BRASS



STEEL FLANGE DESIGN



STEEL WELD ENDS



SPIROCROSS R

Page 20

Page 33

REMARK

Unless indicated otherwise, SpiroTop, SpiroVent, SpiroTrap, SpiroCombi and SpiroCross products are suitable for water and water-glycol mixtures (max. 50%).

ONLINE

TOTAL SOLUTION

Spirotech offers an extensive range of total solutions. For more information, please visit our website: www.spirotech.com

SPIROTOP® SOLAR/SPIROVENT® SOLAR



SPIROVENT RV2

STEEL FLANGE DESIGN

STEEL WELD ENDS



SPIROTOP SOLAR



SPIROVENT SOLAR HORIZONTAL



SPIROVENT SOLAR VERTICAL

SPIROPLUS®



MILD CLEANER



PROTECTOR

SPIROCARE®



PROLAB



SYSTEM ANALYSIS

SPIROPURE®



HOMEFILL BASIC



PROFILL 23.0

SPIROVENT® SUPERIOR



SUPERIOR S400



SUPERIOR S600



SUPERIOR S10



SUPERIOR S16

SPIROPRESS®



PRESSURE CONTROL UNIT EMCK



SPIROVENT SUPERIOR



EXPANSION VESSEL

OTHERS



INSULATION SETS SPIROVENT / SPIROTRAP



FLUSH CONNECTOR



SPIROPLUS PACK



SPIROPLUS RAPIDCLEANSE

GEOTHERMAL ENERGY

- Solar circuit
- Local and district heating system

BIOGAS SYSTEMS

- Local heating system
- Heating and cooling circuit

SOLAR POWER PLANT

- Cooling system
- Local and district heating system

POWER PLANT

- Cooling circuits
- Local and district heating system



The right solution for every application

Whether you are converting an existing system or planning to develop a new heating, cooling or processing system, Spirotech offers the right solution for every need. Almost all our products are scalable to your requirements.



DETACHED HOUSE

- Heating circuit
- Heat pump
- Solar system



APARTMENT BUILDING

- Heating circuit
- Heat pump
- Solar system

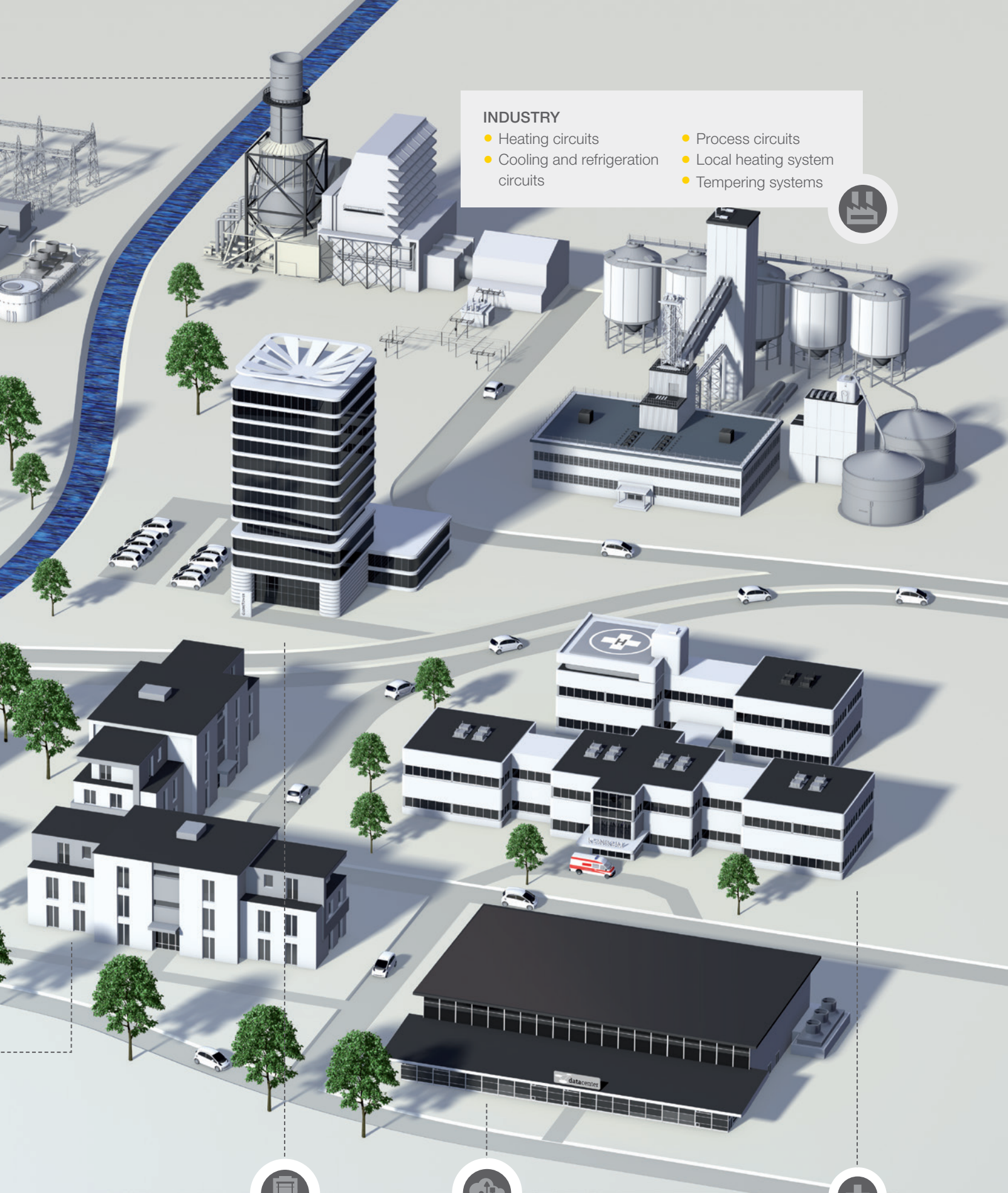

INDUSTRY

- Heating circuits
- Cooling and refrigeration circuits
- Process circuits
- Local heating system
- Tempering systems



**OFFICE BUILDING/
UNIVERSITY/COLLEGE/
SCHOOL**

- Heating circuit
- Cooling circuit
- Air conditioning

DATA CENTRE

- Cooling and refrigeration circuits
- Air conditioning

**HEALTH CENTRE/
HOSPITAL**

- Heating circuits
- Cooling and refrigeration circuits
- Air conditioning

SpiroLife – exceptional guarantee up to 20 years



SpiroLife offers exceptional guarantees for our air and dirt separation products. A 20-year guarantee, unique in the industry, is offered on all standard brass products*.



Our high-quality solutions for deaeration, dirt separation, pressurisation and system water analysis are based on smart concepts, which have proven themselves repeatedly over decades. Of course, such exceptional and reliable products come with exceptional guarantee terms. Our aim is to provide the best possible quality for our clients and end-users, which makes us confident we can safely offer extended warranties.

Our robust products and services bring you energy savings, increased reliability and enhanced comfort. You can also be assured of maximum uptime, reduced maintenance costs and a longer service life for all your heating, cooling and process installations.

SPIROLIFE GUARANTEES

- **SPIROLIFE-GUARANTEE 20-YEAR GUARANTEE**
On standard Spirotech brass products with operational temperatures up to 110 °C (*except marked otherwise)
- **SPIROLIFE-GUARANTEE 5-YEAR GUARANTEE**
On steel products and on brass products with operational temperatures in excess of 110 °C.
- **SPIROLIFE-GUARANTEE 2-YEAR GUARANTEE**
On SpiroVent Superior vacuum degassers and on SpiroPress.



Please note that guarantees are subject to correct selection, installation, maintenance and use of the products, in accordance with our regulations, data sheets and user manuals and do not cover normal wear and tear.

1 SPIROCOMBI®
Steel solution

2 SPIROCOMBI® – Steel solution without magnet – Hi-flow

3 SPECIAL

Art.-No.	DN	OD	H	h1	h	D	L/LF	e1	ext.	e	int.	e2	ext.	x	y	Nom. flow rate	Nom. flow rate	Δp at nom. flow	Volume	Weight
	[mm]	[mm]	[mm]	[mm]	[mm]	[mm]	[mm]							[mm]	[mm]	[m³/h]	[l/s]	[kPa]	[ltr]	[kg]
HC050L	50	60.3	910	505	405	159	260	G¾	(M)	Rp1	(F)	R½	(M)	>200	>50	25.00	6.94	11.7	10.0	18.0
HC050F	50	60.3	910	505	405	159	350	G¾	(M)	Rp1	(F)	R½	(M)	>200	>50	25.00	6.94	11.7	10.0	23.0
HC065L	65	76.1	910	505	405	159	260	G¾	(M)	Rp1	(F)	R½	(M)	>200	>50	40.00	11.11	11.9	10.0	18.0
HC065F	65	76.1	910	505	405	159	350	G¾	(M)	Rp1	(F)	R½	(M)	>200	>50	40.00	11.11	11.9	10.0	24.0
HC080L	80	88.9	1,145	620	525	219	370	G¾	(M)	Rp1	(F)	R½	(M)	>200	>50	54.00	15.00	12.4	37.0	36.0
HC080F	80	88.9	1,145	620	525	219	470	G¾	(M)	Rp1	(F)	R½	(M)	>200	>50	54.00	15.00	12.4	37.0	43.0
HC100L	100	114.3	1,145	620	525	219	370	G¾	(M)	Rp1	(F)	R½	(M)	>200	>50	94.00	26.11	14.7	37.0	36.0
HC100F	100	114.3	1,145	620	525	219	475	G¾	(M)	Rp1	(F)	R½	(M)	>200	>50	94.00	26.11	14.7	37.0	45.0
HC125L	125	139.7	1,570	825	745	324	525	G¾	(M)	Rp1	(F)	R½	(M)	>200	>50	144.00	40.00	16.9	115.0	90.0
HC125F	125	139.7	1,570	825	745	324	635	G¾	(M)	Rp1	(F)	R½	(M)	>200	>50	144.00	40.00	16.9	115.0	102.0
HC150L	150	168.3	1,570	825	745	324	525	G¾	(M)	Rp1	(F)	R½	(M)	>200	>50	215.00	59.72	19.2	115.0	90.0
HC150F	150	168.3	1,570	825	745	324	635	G¾	(M)	Rp1	(F)	R½	(M)	>200	>50	215.00	59.72	19.2	115.0	105.0
HC200F	200	219.1	1,995	1,040	955	406	775	G¾	(M)	Rp1	(F)	R½	(M)	>200	>50	360.00	100.00	23.4	230.0	195.0
HC250F	250	273.0	2,680	1,385	1,295	508	890	G¾	(M)	Rp2	(F)	R½	(M)	>200	>50	575.00	159.72	27.5	500.0	343.0
HC300F	300	323.9	3,190	1,640	1,550	610	1,005	G¾	(M)	Rp2	(F)	R½	(M)	>200	>50	810.00	225.00	31.2	830.0	484.0

Op. pressure max. 10 bar

Temperature max. 110 °C

Nom. flow velocity 3 m/s

without magnet

Products in the range are available up to DN800 and are made to order
Weld ends not available in UK

L = Weld ends / F = Flange design (PN 16)



SPIROCOMBI HI-FLOW FLANGE DESIGN

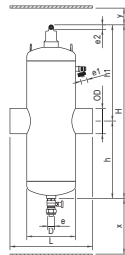

SPIROCOMBI HI-FLOW WELD ENDS

CUSTOM Please visit page 30 for further information on our custom products.

- 1** Name of product group
Title (i.e. reference to brass or steel units)
- 2** Header
measurements, article number, etc.

- 3** Category reference
- 4** Additional information
i.e. description of abbreviations

- 5** Highlighted features
i.e. deviation from cat. specs.
- 6** Technical drawing
illustrations

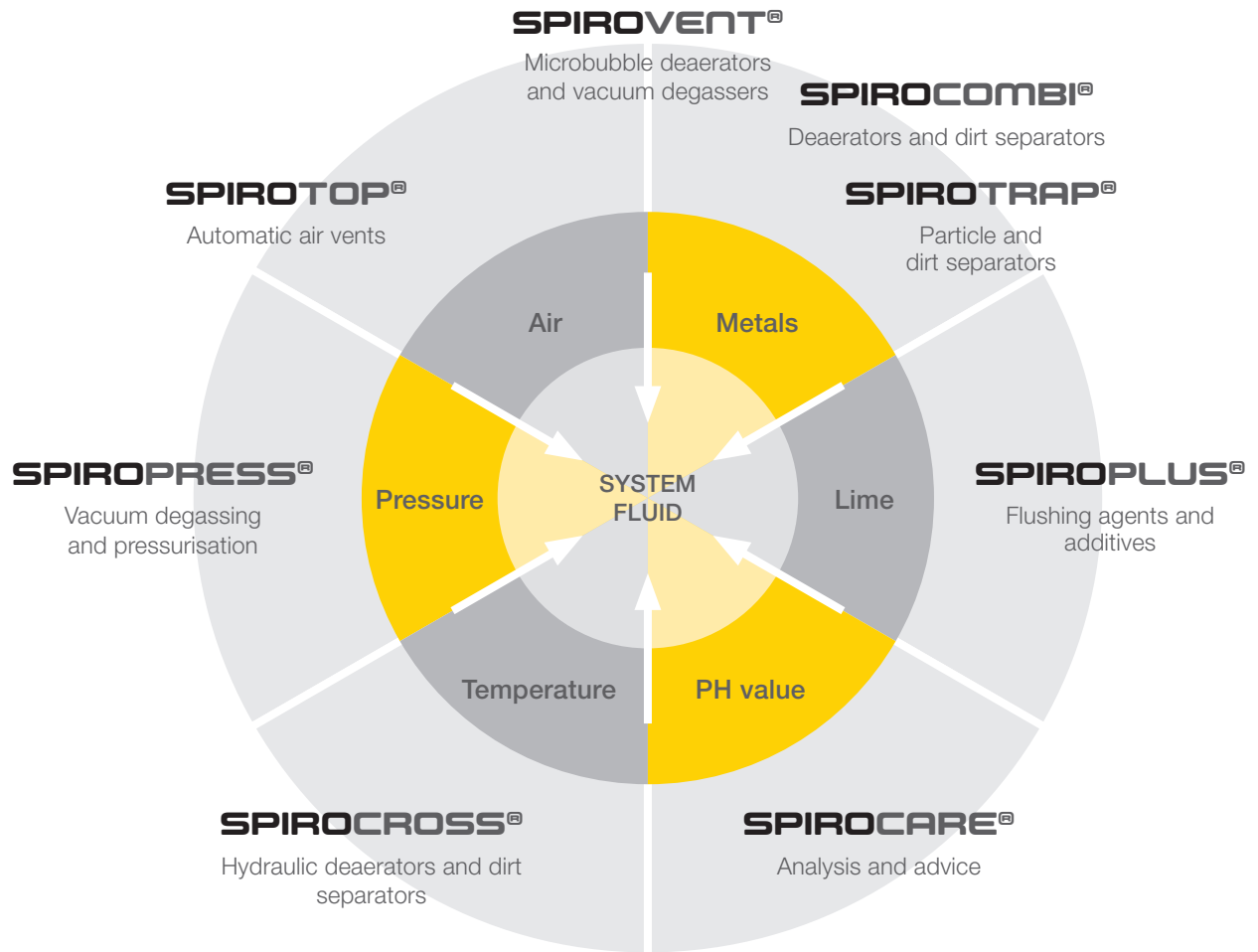

DO YOU WANT TO STAY UP TO DATE?

Visit our website at www.spirotech.com.

Here you will find all the up-to-date information, brochures, manuals and technical data sheets, as well as all customer stories and testimonials concerning fluid conditioning.

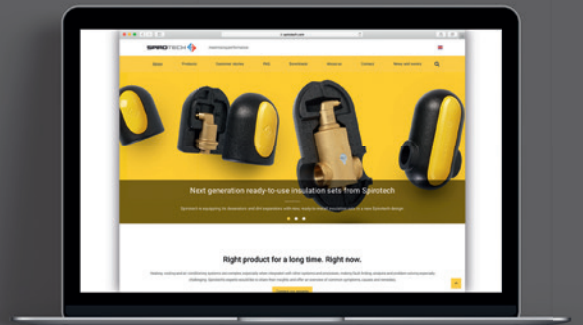

SPIROTECH ARTICLE NUMBER FOR AUTOMATIC AIR VENTS (EXAMPLE)

AB050/R002

A Housing type	B Type/design	050 Nominal diameter	R002 Special
Casting	Air vent	½" internal threads	R 002 Material AISI 316 180 °C FBA AutoClose valve 004 25 bar, 200 °C 007 180 °C, Float AISI 316 008 10 bar, 180 °C

SPIROTECH ARTICLE NUMBER FOR STEEL DIRT SEPARATORS (EXAMPLE)

BE100FM

B Housing type	E Type/design	100 Nominal diameter	F Connections	R Option
B Steel Standard H Steel Hi-flow	E Dirt Separator F Demountable housing base	050 DN 50 065 DN 65 080 DN 80 100 DN 100 125 DN 125 150 DN 150 200 DN 200 250 DN 250 300 DN 300 350 DN 350 400 DN 400 450 DN 450 500 DN 500 600 DN 600	L Welding sockets F Flange	M Magnet R Material AISI 316

Following types are available from DN 50 on request:

	110 °C [max. Temp.]	180 °C [max. Temp.]	10 bar [Max. operating pressure]	16 bar [Max. operating pressure]	25 bar [Max. operating pressure]	Material S235	Material AISI 316
110 °C [max. Temp.]			S	O	O	S	O
180 °C [max. Temp.]			O	O	O	O	O
10 bar [Max. operating pressure]	S	O				S	O
16 bar [Max. operating pressure]	O	O				O	O
25 bar [Max. operating pressure]	O	O				O	O
Material S235	S	O	S	O	O		
Material AISI 316	O	O	O	O	O		

S Standard

O Option on request

Brass solution

Connection size		Brass solution	
[mm]	[int.]	[max. l/s]	[max. m ³ /h]
22	¾"	0.35	1.3
20	¾"	0.35	1.3
25	1"	0.55	2.0
32	1¼"	1.0	3.6
40	1¼"	1.4	5.0
50	2"	2.1	7.5

 Temperature
max. 110 °C

 Nom. flow velocity
1 m/s

Steel solution

Connection size		Steel solution		Δp at max. flow [kPa]
[mm]	[int.]	[max. l/s]	[max. m ³ /h]	
50	2"	3.5	12.5	3.5
65	2½"	5.5	20	2.7
80	3"	7.5	27	2.9
100	4"	13	47	3.7
125	5"	20	72	4.2
150	6"	30	108	4.9
200	8"	50	180	5.8
250	10"	80	288	6.9
300	12"	113	405	7.7

 Temperature
max. 110 °C

 Nom. flow velocity
1.5 m/s

Steel solution – Hi-flow (3 m/s)

50	2"	7	25	11.8
65	2½"	11	40	11.6
80	3"	15	54	12.4
100	4"	26	94	14.6
125	5"	40	144	16.8
150	6"	60	215	19.4
200	8"	100	360	23.1
250	10"	160	575	27.7
300	12"	225	810	31.0

 Temperature
max. 110 °C

 Nom. flow velocity
3 m/s

Steel solution – Standard flow (1.5 m/s)

350	14"	136	490	7.8
400	16"	178	640	8.4
450	18"	225	810	10
500	20"	276	995	11
600	24"	399	1,435	12

 Temperature
max. 110 °C

 Nom. flow velocity
1.5 m/s

Steel solution – Hi-flow (3 m/s)

350	14"	275	990	31
400	16"	358	1,290	34
450	18"	458	1,650	39
500	20"	575	2,070	43
600	24"	825	2,970	47

 Temperature
max. 110 °C

 Nom. flow velocity
3 m/s

SPIROTECH® – Selection charts based on boiler output

SELECTION CHART BASED ON BOILER OUTPUT

		10 KW	15 KW	20 KW	25 KW	30 KW	35 KW	40 KW	45 KW	50 KW	55 KW	60 KW	65 KW
20 K	SPIROTRAP MB	UE022WJ UE075WJ	UE022WJ UE075WJ	UE022WJ UE075WJ	UE022WJ UE075WJ	UE028WJ UE0100WJ	UE028WJ UE0100WJ	UE028WJ UE0100WJ	UE028WJ UE0100WJ	UE125WJ	UE125WJ	UE125WJ	UE150WJ
	SPIROTRAP	AE022 AE075	AE022 AE075	AE022 AE075	AE022 AE075	AE100	AE100	AE100	AE100	AE125	AE125	AE125	AE150
	SPIROVENT RV	UA022W	UA022W	UA022W	UA022W	UA028W	UA028W	UA028W	UA028W				
	SPIROVENT	AA022 AA075	AA022 AA075	AA022 AA075	AA022 AA075	AA100	AA100	AA100	AA100	AA125	AA125	AA125	AA150
15 K	SPIROTRAP MB	UE022WJ UE075WJ	UE022WJ UE075WJ	UE022WJ UE075WJ	UE028WJ UE0100WJ	UE028WJ UE0100WJ	UE125WJ	UE125WJ	UE125WJ	UE125WJ	UE150WJ	UE150WJ	UE150WJ
	SPIROTRAP	AE022 AE075	AE022 AE075	AE022 AE075	AE100	AE100	AE125	AE125	AE125	AE125	AE150	AE150	AE150
	SPIROVENT RV	UA022W	UA022W	UA022W	UA028W	UA028W							
	SPIROVENT	AA022 AA075	AA022 AA075	AA022 AA075	AA100	AA100	AA125	AA125	AA125	AA125	AA150	AA150	AA150
10 K	SPIROTRAP MB	UE022WJ UE075WJ	UE022WJ UE075WJ	UE028WJ UE100WJ	UE125WJ	UE125WJ	UE150WJ	UE150WJ	UE150WJ	UE150WJ	UE150WJ	UE200WJ	UE200WJ
	SPIROTRAP	AE022 AE075	AE022 AE075	AE100	AE125	AE125	AE150	AE150	AE150	AE150	AE150	AE200	AE200
	SPIROVENT RV	UA022W	UA022W	UA028W									
	SPIROVENT	AA022 AA075	AA022 AA075	AA100	AA125	AA125	AA150	AA150	AA150	AA150	AA150	AA200	AA200
7.5 K	SPIROTRAP MB	UE022WJ UE075WJ	UE028WJ UE0100WJ	UE125WJ	UE125WJ	UE125WJ	UE150WJ	UE150WJ	UE150WJ	UE200WJ	UE200WJ	UE200WJ	UE200WJ
	SPIROVENT RV	UA022W	UA028W										
	SPIROTRAP	AE022 AE075	AE100	AE125	AE125	AE125	AE150	AE150	AE150	AE200	AE200	AE200	AE200
	SPIROVENT	AA022 AA075	AA100	AA125	AA125	AA125	AA150	AA150	AA150	AA200	AA200	AA200	AA200

		70 KW	75 KW	80 KW	85 KW	90 KW	95 KW	100 KW	105 KW	110 KW	115 KW	120 KW	125 KW	130 KW	135 KW
20 K	SPIROTRAP MB	UE150WJ	UE150WJ	UE150WJ	UE150WJ	UE150WJ	UE150WJ	UE150WJ	UE150WJ	UE150WJ	UE150WJ	UE200WJ	UE200WJ	UE200WJ	UE200WJ
	SPIROTRAP	AE150	AE150	AE150	AE150	AE150	AE150	AE150	AE150	AE150	AE150	AE200	AE200	AE200	AE200
	SPIROVENT	AA150	AA150	AA150	AA150	AA150	AA150	AA150	AA150	AA150	AA150	AA200	AA200	AA200	AA200
15 K	SPIROTRAP MB	UE150WJ	UE150WJ	UE150WJ	UE150WJ	UE200WJ	UE200WJ	UE200WJ	UE200WJ	UE200WJ	UE200WJ	UE200WJ	UE200WJ	UE200WJ	
	SPIROTRAP	AE150	AE150	AE150	AE150	AE200	AE200	AE200	AE200	AE200	AE200	AE200	AE200	AE200	
	SPIROVENT	AA150	AA150	AA150	AA150	AA200	AA200	AA200	AA200	AA200	AA200	AA200	AA200	AA200	
10 K	SPIROTRAP MB	UE200WJ	UE200WJ	UE200WJ	UE200WJ										
	SPIROTRAP	AE200	AE200	AE200	AE200										
	SPIROVENT	AA200	AA200	AA200	AA200										
7.5 K	SPIROTRAP MB	UE200WJ	UE200WJ	UE200WJ	UE200WJ										
	SPIROTRAP	AE200	AE200	AE200	AE200										
	SPIROVENT	AA200	AA200	AA200	AA200										

HEAT OUTPUT TABLE BASED ON FLOWS RATE

	Temperature spread			
	7.5 K	10 K	15 K	20 K
10 KW	1,146	860	573	430
15 KW	1,720	1,290	860	645
20 KW	2,293	1,720	1,146	860
25 KW	2,866	2,150	1,433	1,075
30 KW	3,439	2,580	1,720	1,290
35 KW	4,013	3,009	2,006	1,505
40 KW	4,586	3,439	2,293	1,720
45 KW	5,159	3,869	2,580	1,935
50 KW	5,732	4,299	2,866	2,150
55 KW	6,306	4,729	3,153	2,365
60 KW	6,879	5,159	3,439	2,580
65 KW	7,452	5,589	3,726	2,794
70 KW	8,025	6,019	4,013	3,009
75 KW	8,598	6,449	4,299	3,224
80 KW	9,172	6,879	4,586	3,439
85 KW	9,745	7,309	4,872	3,654
90 KW	10,318	7,739	5,159	3,869
95 KW	10,891	8,169	5,446	4,084
100 KW	11,465	8,598	5,732	4,299
105 KW	12,038	9,028	6,019	4,514
110 KW	12,611	9,458	6,306	4,729
115 KW	13,184	9,888	6,592	4,944
120 KW	13,758	10,318	6,879	5,159
125 KW	14,331	10,748	7,165	5,374
130 KW	14,904	11,178	7,452	5,589
135 KW	15,477	11,608	7,739	5,804
140 KW	16,050	12,038	8,025	6,019
145 KW	16,624	12,468	8,312	6,234
150 KW	17,197	12,898	8,598	6,449
155 KW	17,770	13,328	8,885	6,664
160 KW	18,343	13,758	9,172	6,879
165 KW	18,917	14,187	9,458	7,094
170 KW	19,490	14,617	9,745	7,309

Results in litres/h, heat requirement in kW

2" BRASS UNITS

Selection table SpiroVent/SpiroTrap up to 2" brass units

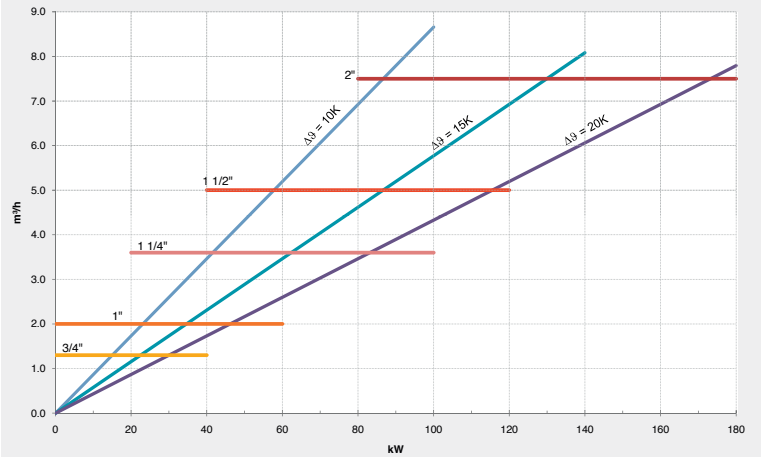

DN 125 STEEL UNITS

Selection table SpiroVent/SpiroTrap up to DN 125 steel units

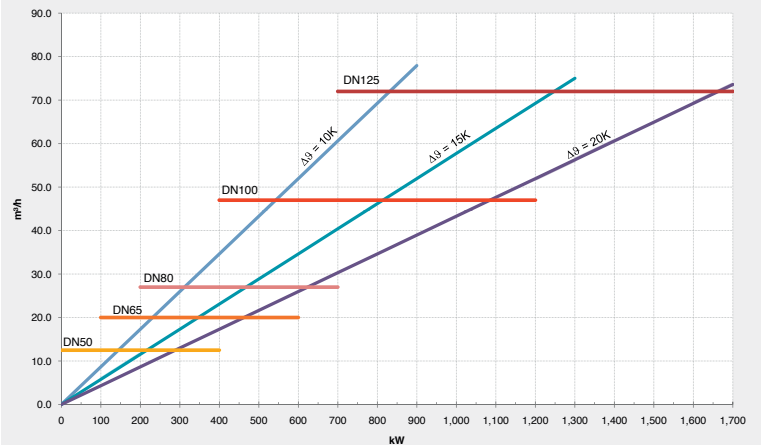

STATIC HEIGHT DESIGN CRITERIA FOR SPIROTECH INLINE UNITS

In case of an excessive static head (pressure) above a deaerator, dissolved air cannot be released from the fluid. Under these circumstances it is very hard to predict where in the system air bubbles will emerge from the fluid. Apart from that, the point where microbubbles emerge can change depending on fluid temperature and hydrostatic

pressure (Henry's Law). Rule of thumb for maximal static height: heating ≤ 15 m, cooling ≤ 5 m. Above the critical height, a vacuum degasser is generally a more effective solution. For custom made advice, please contact us.

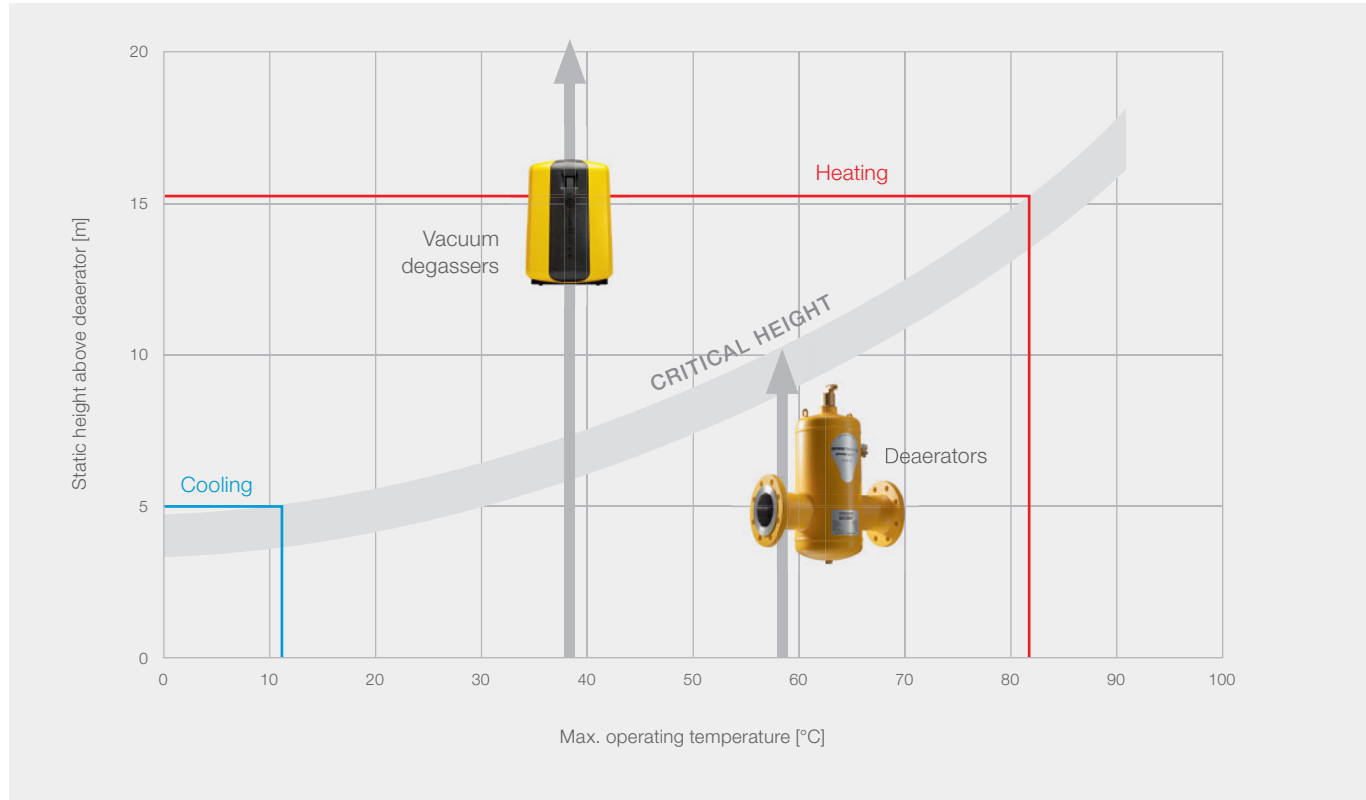

HENRY'S LAW APPLIES TO EVERY SYSTEM AND STATES THE FOLLOWING:

Gas will dissolve in a fluid until there is a balance between the partial pressure of the gas in the fluid and the partial pressure of the same gas outside the fluid. It also applies that in a fluid under the influence of pressure and temperature, a certain maximum amount of gas can be dissolved. This also means that as the temperature or pressure changes, gases can be emitted.

Therefore, temperature and pressure influence the property which allows water to absorb or emit air. A heating or cooling system is a constant string of pressure and temperature variations.

CATEGORISATION OF PRODUCTS

Introduced in 2016 to support a faster and easier navigation of our product catalogue.
Read below about the new categories and their specification.

STANDARD SOLUTIONS

- Max. operating pressure up to 10 bar
- Fluid temperature up to 110 °C
- Nominal flow velocity up to 1.5 m/s.

Products which meet the specifications noted above are considered standard solutions.

SPECIAL SOLUTIONS

Products, which divert from the standard parameters. For example our Hi-flow product range, which is designed for a nominal flow velocity of 3 m/s.

CUSTOM SOLUTIONS

In addition to the models listed in the product catalogue, Spirotech offers customisation options (see table below). In case you experience any difficulties selecting from our options, or would like to discuss a more complex situation, please contact you local Spirotech office.

Product family	Material	Stainless steel		60 Hz	Insulation for cooling solutions	Closed cover	Demountable***		Leg support**	Housing		High pressure		High temperatures		Hi-flow	Magnet*	ANSI flange	Victaulic connection	Certificate for tracability	
		Spirotube (Spirotroll)	Piping/Vessel etc.				Bottom	Top		Stainless steel	Powder coating	16 bar	25 bar	180 °C	180–200 °C					With stamping	Without stamping
SPIROVENT®	Brass	x																			
	Steel	x						x	x	x	x	x	x	x	x	x		x	x	x	x
SPIROVENT® SUPERIOR	-		x	x	x	x															
SPIROTRAP®	Brass	x																			
	Steel	x					x		x	x	x	x	x	x	x	x	x	x	x	x	x
SPIROCOMBI®	Brass	x																			
	Steel	x					x		x	x	x	x	x	x	x	x	x	x	x	x	x
SPIRO CROSS®	Brass	x																			
	Steel	x							x	x	x	x	x	x	x			x	x	x	x

REMARKS:

Please note, that not all options are available in any combination.

For ordering a custom product, please contact Spirotech.

* Up to DN 300 and up to 10 bar for SpiroTrap and SpiroCombi, no Hi-flow, up to 110 °C, if it is in combination with Stainless steel (SS) then only up to DN 200

** From DN 200 and bigger

*** SpiroVent and SpiroTrap up to DN 600, SpiroCombi up to DN 400 and SpiroCombi Hi-flow up to DN 300



Demountable



Hi-flow

SPIROTOP[®]

AUTOMATIC AIR VENTS

SPIROVENT[®]

MICROBUBBLE DEAERATORS

**SPIROTOP[®] SOLAR
SPIROVENT[®] SOLAR**

AUTOMATIC AIR VENTS AND DEAERATORS
FOR SOLAR INSTALLATIONS

SPIROVENT[®] SUPERIOR

VACUUM DEGASSERS

SPIROTRAP[®]

PARTICLE AND DIRT SEPARATORS

SPIROCOMBI[®]

DEAERATORS AND DIRT SEPARATORS

SPIROCROSS[®]

HYDRAULIC DEAERATORS AND DIRT SEPARATORS

SPIROPRESS[®]

VACUUM DEGASSING AND PRESSURISATION

SPIROPURE[®]

DEMINERALIZATION

SPIROPLUS[®]

FLUSHING AGENTS AND ADDITIVES

OTHERS

ACCESSORIES, SPARE PARTS, USEFUL INFORMATION

AUTOMATIC AIR VENTS

SPIROTOP®



Industry-leading
20-year guarantee



No valve contamination
due to distance from water



Special leak-free
valve construction

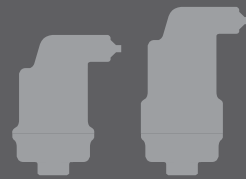

Extensive range of models

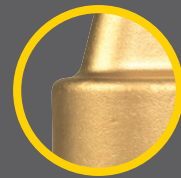

Sturdy brass and
stainless steel units

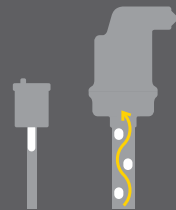

1/2" connection
prevents bubble blockage

All images used are for illustrative purposes only. Individual features like material used (i.e. brass or steel) may vary, as may guarantee.

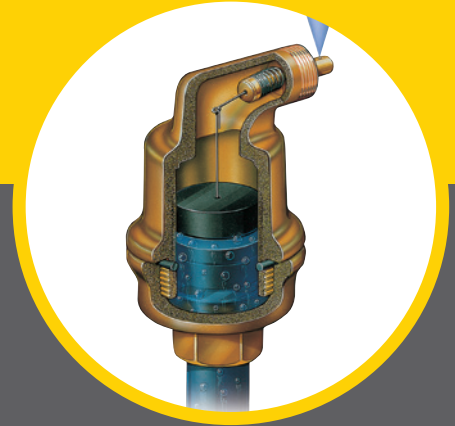

BENEFITS OF SPIROTOP

The combination of the characteristics listed below ensures that the automatic SpiroTop will not leak:

- The special valve construction makes sure that the valve is closed completely
- The special valve seat has a very long life expectancy
- The robust floats are made of solid plastic so they cannot rupture
- The large air gap between the valve and the water (at least 40 mm) prevents valve contamination which is one of the main causes of leaks
- The ½" connection prevents the pipette effect

SPIROTOP AUTOMATIC AIR VENTS

SpiroTop automatic air vents quickly and effectively remove free air and allow for fast, reliable aeration when a system is drained. This prevents component damage and system failure. Available for pressures up to 25 bar and temperatures up to 200 °C.

PREVENT FUTURE COSTS

Air and other gases trapped at one or more high points in a system can obstruct the flow at these spots or even stop it altogether. If gases are not sufficiently removed, commissioning problems may occur, frequent manual venting will be required and pumps will need to run at a higher rate, using more energy due to a bigger pressure drop. Bubbles travel and by doing so they may interfere with the control valves authority. Eventually, expensive system components will be damaged, leading to system and process malfunctions or even total failure.

PREVENTING CONTAMINATION AND LEAKAGE

SpiroTop provides a solution for filling and venting systems, making and keeping the high points in pipe systems air-free and preventing air pockets from forming. The significant gap between the valve and the water (at least 40 mm) prevents valve contamination, one of the main causes of leaks. Thanks to a reliable venting mechanism and special construction, the valve closes completely and is protected against

leaking. The special valve seat has a very long life. A SpiroTop is connected to the system by a female ½" connection. With smaller connections, bubble blockage may occur and the device stops working adequately.

The most commonly used SpiroTop (AB050) comes with an industry-leading 20-year guarantee. All other models have a 5 year guarantee period.



SpiroTop is the reliable and worry-free solution ideal for:

- filling and draining systems
- making and keeping the highest points in systems air-free

STANDARD

SPIROTOP® – Brass solution for standard temperature and pressure

Art.-No.	Connection d	int.	H [mm]	b [mm]	B [mm]	D [mm]	y [mm]	e2 [mm]	ext.	Material: housing	Material: float	Weight [kg]
AB050	G½	(F)	112	52	86	65	>50	R½	(M)	Brass	PP	0.7



Op. pressure
max. 10 bar



Temperature
max. 110 °C

SPECIAL

SPIROTOP® – Brass solution for high pressure

Art.-No.	Connection d	int.	H [mm]	b [mm]	B [mm]	D [mm]	y [mm]	e2 [mm]	ext.	Material: housing	Material: float	Weight [kg]
AB050/030	G½	(F)	112	52	86	65	>50	R½	(M)	Brass	PP	0.7



Op. pressure
max. 16 bar



Temperature
max. 110 °C

SPIROTOP® – Brass solution for high temperature and high pressure

AB050/025	G½	(F)	134	52	86	65	>50	R½	(M)	Brass	TPX	1.0
-----------	----	-----	-----	----	----	----	-----	----	-----	-------	-----	-----



Op. pressure
max. 25 bar



Temperature
max. 150 °C

SPIROTOP® – Brass solution for high temperature

AB050/002	G½	(F)	112	52	86	65	>50	R½	(M)	Brass	TPX	0.7
AB050/007	G½	(F)	112	52	86	65	>50	R½	(M)	Brass	AISI 316	0.6



Op. pressure
max. 10 bar



Temperature
max. 180 °C

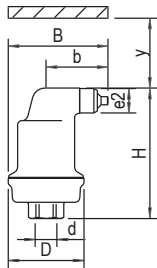

SPIROTOP

ACCESSORIES

SPIROTOP® – Accessories for brass solution

Art.-No.	Description	Suitable for
TAB050	Insulation Set	AB050, AB050/030

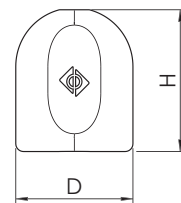

TAB050



Have you thought of a dirt separator?
Learn more on page 12.

SPIROTOP®
Stainless Steel solution

SPECIAL

SPIROTOP® – Stainless Steel solution for high temperature

Art.-No.	Connection d	int.	H [mm]	b [mm]	B [mm]	D [mm]	y [mm]	e2 [mm]	ext.	Material: housing	Material: float	Weight [kg]
AB050/R002	G½	(F)	112	52	86	65	>50	R½	(M)	AISI 316	TPX	0.7
AB050/R007	G½	(F)	112	52	86	65	>50	R½	(M)	AISI 316	AISI 316	0.6

 Op. pressure
max. 10 bar

 Temperature
max. 180 °C

SPIROTOP® – Stainless Steel solution for high temperature and high pressure

AB050/R004	G½	(F)	134	52	86	65	>50	R½	(M)	AISI 316	TPX	1.0
------------	----	-----	-----	----	----	----	-----	----	-----	----------	-----	-----

 Op. pressure
max. 25 bar

 Temperature
max. 200 °C

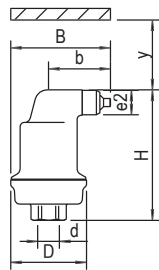

SPIROTOP

 Have you thought of a dirt separator?
Learn more on page 12.

MICROBUBBLE DEAERATORS

SPIROVENT®



Industry-leading
20-year guarantee



Reduction of
maintenance and malfunction



Energy saving

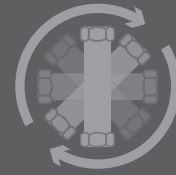

Quick and easy, universal
installation (360°)



Sturdy brass
housing



Reliable, leak-free
venting system

All images used are for illustrative purposes only. Individual features like material used (i.e. brass or steel) may vary, as may guarantee.

SPIROVENT®



BENEFITS OF SPIROVENT

- Removes all circulating air and microbubbles effectively
- Removes trapped air when installed at the correct location
- Greatly reduces the need for manual venting
- Constant low pressure drop
- No unnecessary shutdown
- Connection diameters from ¾" to DN 800 (see page 30 for additional options)
- A complete range, suitable for various pressures and temperatures
- Exceptional guarantee

Shortly after the first decade of Spirotech's existence a game-changing product family was announced. By introducing the SpiroVent in 1968, Spirotech laid the foundation of understanding microbubble deaeration and optimising performance of HVAC systems. 50 years later, the SpiroVent microbubble deaerator range stands stronger than ever. The once narrow product range, now offers a broad and well customizable portfolio. From ¾" up to DN 800, from brass to steel, from normal- to high-flow, a wide variety of microbubble deaerators are being manufactured in the Netherlands to satisfy customer needs.

Check the Spirotech website for more on the 50th anniversary of our beloved SpiroVent.

SPIROVENT MICROBUBBLE DEAERATORS

SpiroVent microbubble deaerators are installed inline and continuously remove free air and microbubbles from the system fluid.

A SpiroVent deaerator should always be installed at the hottest point within a system. In the case of a heating system, for example, this is the point where the water exits the boiler. In the case of a cooling system, it is in the return before the chiller unit. When installed in the correct location a SpiroVent has the capability to deaerate the entire system as it can make the water absorptive to remaining air in the system.

WHY USE SPIROVENT PRODUCTS?

Today's highly energy-efficient heating and cooling systems offer optimal performance with air-free system water. Automatic air vents and bleeding valves cannot remove microbubbles or circulating air. Venting devices on boilers and other devices will not remove air that is present elsewhere in the system. Furthermore, presence of air is the major cause of dirt formation corrosion and related negative effects on efficiency, failure sensitivity and wear and tear.

HOW DOES IT WORK?

The SpiroVent is a fully universal deaerator that works non-stop to effectively remove circulating air and microbubbles from system water. At the heart of the SpiroVent is the Spirotube separation element, which ensures that microbubbles are separated from the water flow, allowing them to rise up to the air chamber. The specially constructed air chamber provides sufficient volume to absorb pressure fluctuations and prevents valve contamination. This is one of the main causes of leaks. Thanks to the special construction and the solid valve seat, the leak-proof air release valve opens, releases the air and always closes perfectly. This avoids unwanted entry of air from outside the system.

UNIQUE FOR SPIROVENT RV2

The sturdy brass SpiroVent RV2 is equipped with a swivel connection making it very easy to install, also ideal for existing pipework because of the slide-over compression coupling. Thanks to the swivel connection, the SpiroVent RV2 is suitable for horizontal, vertical, and diagonal pipes.



Studies from Kiwa GASTEC, BSRIA, TNO and others show SpiroVent deaerators can save up to 6% on energy consumption.



SPIROVENT® RV2 – Brass solution with universal connection

Art.-No.	Conne- tion d	int.	Hv	Hh	b	L	D	h	h1	B	x	y	e2	ext.	Nom. flow rate	Nom. flow rate	Δp at nom. flow	Volume	Weight
			[mm]	[mm]	[mm]	[mm]	[mm]	[mm]	[mm]	[mm]	[mm]	[mm]	[mm]		[m ³ /h]	[l/s]	[kPa]	[ltr]	[kg]
UA022W	22 mm	(M)	205	177	125	120	62	32	145	143	>50	>50	M4	(F)	1.30	0.36	2.1	0.18	1.8
UA028W	28 mm	(M)	205	177	128	120	62	32	145	151	>50	>50	M4	(F)	2.00	0.56	3.8	0.18	1.8
UA075W	G¾	(F)	195	177	127	100	62	32	145	144	>50	>50	M4	(F)	1.30	0.36	2.1	0.38	1.6
UA100W	G1	(F)	195	177	131	100	62	32	145	154	>50	>50	M4	(F)	2.00	0.56	3.8	0.41	1.8
UA125W	Rp1¼	(F)	290	276	149	128	80	50	226	174	>50	>50	R½	(M)	3.60	1.00	2.5	1.12	4.0
UA150W	Rp1½	(F)	290	276	152	128	80	50	226	179	>50	>50	R½	(M)	5.00	1.40	4.0	1.16	4.0
UA200W	Rp2	(F)	310	296	159	128	80	50	246	194	>50	>50	R½	(M)	7.50	2.10	8.3	1.38	5.0



Op. pressure
max. 10 bar



Temperature
max. 110 °C



Nom. flow velocity
1 m/s

STANDARD

SPIROVENT® – Brass solution with horizontal connection

Art.-No.	Conne- tion d	int.	H	Hh	b	L	D	h	h1	B	x	y	e2	ext.	Nom. flow rate	Nom. flow rate	Δp at nom. flow	Volume	Weight
			[mm]	[mm]	[mm]	[mm]	[mm]	[mm]	[mm]	[mm]	[mm]	[mm]	[mm]		[m ³ /h]	[l/s]	[kPa]	[ltr]	[kg]
AA022	22 mm	-	154	-	52	105	65	21	133	106	>50	>50	R½	(M)	1.30	0.36	1.3	0.2	1.2
AA075	G¾	(F)	154	-	52	85	65	21	133	96	>50	>50	R½	(M)	1.30	0.36	1.3	0.2	1.0
AA100	G1	(F)	180	-	52	88	65	35	145	97	>50	>50	R½	(M)	2.00	0.56	1.3	0.2	1.3
AA125	G1¼	(F)	198	-	52	88	65	39	159	97	>50	>50	R½	(M)	3.60	1.00	1.3	0.3	1.4
AA150	G1½	(F)	234	-	52	88	65	42	192	97	>50	>50	R½	(M)	5.00	1.39	1.3	0.3	1.6
AA200	G2	(F)	276	-	52	132	100	59	217	119	>50	>50	R½	(M)	7.50	2.08	1.4	1.1	3.9



Op. pressure
max. 10 bar



Temperature
max. 110 °C



Nom. flow velocity
1 m/s

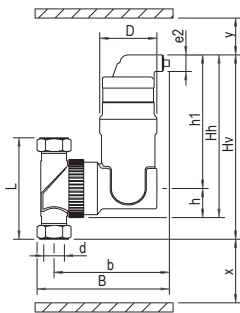

SPIROVENT RV2

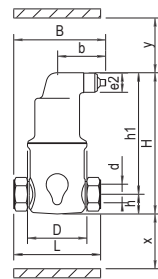



SPIROVENT
HORIZONTAL

SPECIAL

SPIROVENT® – Brass solution for high temperature

Art.-No.	Conne- tion d	int.	H	Hh	b	L	D	h	h1	B	x	y	e2	ext.	Nom. flow rate	Nom. flow rate	Δp at nom. flow	Volume	Weight
			[mm]	[mm]	[mm]	[mm]	[mm]	[mm]	[mm]	[mm]	[mm]	[mm]			[m³/h]	[l/s]	[kPa]	[ltr]	[kg]
AA022/002	22 mm	-	154	-	52	105	65	21	133	106	>50	>50	R½	(M)	1.30	0.36	n/a	0.2	1.2
AA075/002	G¾	(F)	154	-	52	85	65	21	133	96	>50	>50	R½	(M)	1.30	0.36	n/a	0.2	1.0
AA100/002	G1	(F)	180	-	52	88	65	35	145	97	>50	>50	R½	(M)	2.00	0.56	n/a	0.2	1.3
AA125/002	1¼	(F)	198	-	52	88	65	39	159	97	>50	>50	R½	(M)	3.60	1.00	n/a	0.3	1.4
AA150/002	G1½	(F)	234	-	52	88	65	42	192	97	>50	>50	R½	(M)	5.00	1.39	n/a	0.3	1.6

 Op. pressure
max. 10 bar

 Temperature
max. 180 °C

SPIROVENT® – Brass solution for high temperature and high pressure

Art.-No.	Conne- tion d	int.	H	Hh	b	L	D	h	h1	B	x	y	e2	ext.	Nom. flow rate	Nom. flow rate	Δp at nom. flow	Volume	Weight
			[mm]	[mm]	[mm]	[mm]	[mm]	[mm]	[mm]	[mm]	[mm]	[mm]			[m³/h]	[l/s]	[kPa]	[ltr]	[kg]
AA075/025	G¾	(F)	176	-	52	85	65	21	155	96	>50	>50	R½	(M)	1.30	0.36	n/a	0.2	1.4
AA100/025	G1	(F)	202	-	52	88	65	35	167	97	>50	>50	R½	(M)	2.00	0.56	n/a	0.2	1.6
AA125/025	G1¼	(F)	220	-	52	88	65	39	181	97	>50	>50	R½	(M)	3.60	1.00	n/a	0.3	1.8
AA150/025	G1½	(F)	256	-	52	88	65	42	214	97	>50	>50	R½	(M)	5.00	1.39	n/a	0.3	1.9

 Op. pressure
max. 25 bar

 Temperature
max. 150 °C

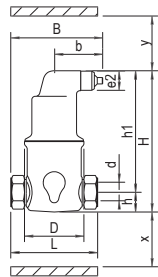

SPIROVENT
HORIZONTAL

CUSTOM

Please visit page 30 for further information on our custom products.

SPIROVENT®
Stainless steel solution

SPECIAL

SPIROVENT® – Stainless steel solution for high temperature

Art.-No.	Connection d	int.	H [mm]	b [mm]	L [mm]	D [mm]	h [mm]	h1 [mm]	B [mm]	x [mm]	y [mm]	e2	ext.	Material: housing	Material: float
AA125/R002	G1¼	(F)	198	52	88	65	39	159	97	>50	>50	R½	(M)	AISI 316	TPX
AA125/R007	G1¼	(F)	198	52	88	65	39	159	97	>50	>50	R½	(M)	AISI 316	AISI 316



Op. pressure
max. 10 bar



Temperature
max. 180 °C

SPIROVENT® – Stainless steel solution for high temperature and high pressure

Art.-No.	Connection d	int.	H [mm]	b [mm]	L [mm]	D [mm]	h [mm]	h1 [mm]	B [mm]	x [mm]	y [mm]	e2	ext.	Material: housing	Material: float
AA125/R004	G1¼	(F)	220	52	88	65	39	181	97	>50	>50	R½	(M)	AISI 316	TPX



Op. pressure
max. 25 bar



Temperature
max. 200 °C

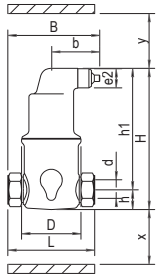

SPIROVENT
HORIZONTAL

CUSTOM

Please visit page 30 for further information on our custom products.

ACCESSORIES

SPIROVENT® – Accessories for brass solution

Art.-No.	Description	Suitable for
TAA150	Insulation set	AA022, AA075, AA100, AA125, AA150
TAR200	Insulation set G2/2" horizontal connection	AA200
TUR100	Insulation set universal connection 22/28 mm	UA022W, UA028W
TUR125	Insulation set G1¼	UA125W
TUR150	Insulation set G1½	UA150W
TUR200	Insulation set G2	UA200W

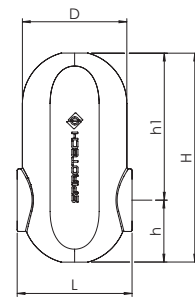

TAR200





Have you thought of a dirt separator?
Learn more on page 12.

SPIROVENT® – Steel solution – standard flow

STANDARD

Art.-No.	DN	OD	H	L/LF	D	h	h1	e1	ext.	x	y	e2	ext.	Nom. flow rate	Nom. flow rate	Δp at nom. flow	Volume	Weight
		[mm]	[mm]	[mm]	[mm]	[mm]	[mm]			[mm]	[mm]			[m ³ /h]	[l/s]	[kPa]	[ltr]	[kg]
BA050L	50	60.3	470	260	159	120	350	G¾	(M)	>50	>50	R½	(M)	12.50	3.47	3.0	5.0	9.0
BA050F	50	60.3	470	350	159	120	350	G¾	(M)	>50	>50	R½	(M)	12.50	3.47	3.0	5.0	14.0
BA065L	65	76.1	470	260	159	130	340	G¾	(M)	>50	>50	R½	(M)	20.00	5.56	2.7	5.0	9.0
BA065F	65	76.1	470	350	159	130	340	G¾	(M)	>50	>50	R½	(M)	20.00	5.56	2.7	5.0	15.0
BA080L	80	88.9	580	370	219	150	430	G¾	(M)	>50	>50	R½	(M)	27.00	7.50	2.9	17.0	18.0
BA080F	80	88.9	580	470	219	150	430	G¾	(M)	>50	>50	R½	(M)	27.00	7.50	2.9	17.0	25.0
BA100L	100	114.3	580	370	219	160	420	G¾	(M)	>50	>50	R½	(M)	47.00	13.06	3.7	17.0	18.0
BA100F	100	114.3	580	475	219	160	420	G¾	(M)	>50	>50	R½	(M)	47.00	13.06	3.7	17.0	27.0
BA125L	125	139.7	750	525	324	195	555	G¾	(M)	>50	>50	R½	(M)	72.00	20.00	4.2	50.0	42.0
BA125F	125	139.7	750	635	324	195	555	G¾	(M)	>50	>50	R½	(M)	72.00	20.00	4.2	50.0	54.0
BA150L	150	168.3	750	525	324	210	540	G¾	(M)	>50	>50	R½	(M)	108.00	30.00	4.9	50.0	42.0
BA150F	150	168.3	750	635	324	210	540	G¾	(M)	>50	>50	R½	(M)	108.00	30.00	4.9	50.0	57.0
BA200F	200	219.1	1,000	775	406	290	710	G¾	(M)	>50	>50	R½	(M)	180.00	50.00	5.8	105.0	106.0
BA250F	250	273.0	1,250	890	508	385	865	G¾	(M)	>50	>50	R½	(M)	288.00	80.00	6.9	210.0	171.0
BA300F	300	323.9	1,465	1,005	610	450	1,015	G¾	(M)	>50	>50	R½	(M)	405.00	112.50	7.7	350.0	251.0

 Op. pressure
max. 10 bar

 Temperature
max. 110 °C

 Nom. flow velocity
1.5 m/s

Products in the range are available up to DN800 and are made to order – prices on application.

L = Weld ends / F = Flange design (PN 16)

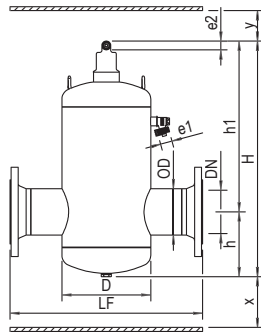

SPIROVENT
FLANGE DESIGN

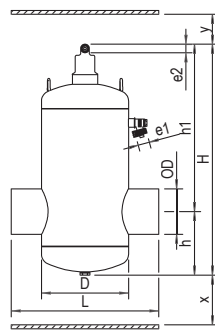

SPIROVENT
WELD ENDS

SPIROVENT®

Steel solution

SPIROVENT® – Steel solution – Hi-flow

Art.-No.	DN	OD	H	L/LF	D	h	h1	e1	ext.	x	y	e2	ext.	Nom. flow rate	Nom. flow rate	Δp at nom. flow	Volume	Weight
HA050L	50	60.3	630	260	159	120	510	G¾	(M)	>50	>50	R½	(M)	25.00	6.94	11.7	7.0	12.0
HA050F	50	60.3	630	350	159	120	510	G¾	(M)	>50	>50	R½	(M)	25.00	6.94	11.7	7.0	17.0
HA065L	65	76.1	630	260	159	130	500	G¾	(M)	>50	>50	R½	(M)	40.00	11.11	11.9	7.0	12.0
HA065F	65	76.1	630	350	159	130	500	G¾	(M)	>50	>50	R½	(M)	40.00	11.11	11.9	7.0	19.0
HA080L	80	88.9	780	370	219	150	630	G¾	(M)	>50	>50	R½	(M)	54.00	15.00	12.4	25.0	24.0
HA080F	80	88.9	780	470	219	150	630	G¾	(M)	>50	>50	R½	(M)	54.00	15.00	12.4	25.0	32.0
HA100L	100	114.3	780	370	219	160	620	G¾	(M)	>50	>50	R½	(M)	94.00	26.11	14.7	25.0	24.0
HA100F	100	114.3	780	475	219	160	620	G¾	(M)	>50	>50	R½	(M)	94.00	26.11	14.7	25.0	33.0
HA125L	125	139.7	1,030	525	324	195	835	G¾	(M)	>50	>50	R½	(M)	144.00	40.00	16.9	75.0	59.0
HA125F	125	139.7	1,030	635	324	195	835	G¾	(M)	>50	>50	R½	(M)	144.00	40.00	16.9	75.0	71.0
HA150L	150	168.3	1,030	525	324	210	820	G¾	(M)	>50	>50	R½	(M)	215.00	59.72	19.2	75.0	59.0
HA150F	150	168.3	1,030	635	324	210	820	G¾	(M)	>50	>50	R½	(M)	215.00	59.72	19.2	75.0	74.0
HA200F	200	219.1	1,340	775	406	290	1,050	G¾	(M)	>50	>50	R½	(M)	360.00	100.00	23.4	150.0	137.0
HA250F	250	273.0	1,750	890	508	385	1,365	G¾	(M)	>50	>50	R½	(M)	575.00	159.72	27.5	300.0	212.0
HA300F	300	323.9	2,060	1,005	610	450	1,610	G¾	(M)	>50	>50	R½	(M)	810.00	225.00	31.2	500.0	392.0



Op. pressure
max. 10 bar



Temperature
max. 110 °C



Nom. flow velocity
3 m/s

Products in the range are available up to DN800 and are made to order – prices on application.

L = Weld ends / F = Flange design (PN 16)

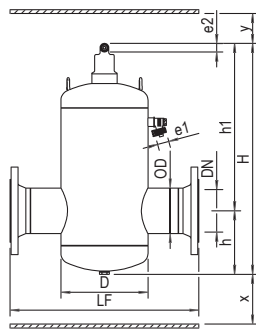

SPIROVENT
FLANGE DESIGN

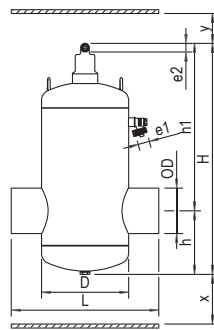

SPIROVENT
WELD ENDS

CUSTOM

Please visit page 30 for further information on our custom products.

SPIROVENT® – Accessories for steel solution

Art.-No.	Description	Suitable for
TB050	Insulation Set for SpiroVent DN 50 + 65	BA050F/L, BA065F/L
TB080	Insulation Set for SpiroVent DN 80 + 100	BA080F/L, BA100F/L
TB125	Insulation Set for SpiroVent DN 125 + 150	BA125F/L, BA150F/L

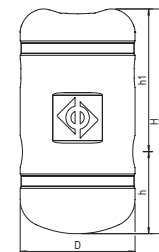

SPIROVENT
INSULATION



Have you thought of a dirt separator?
Learn more on page 12.

AUTOMATIC AIR VENTS AND DEAERATORS
FOR SOLAR INSTALLATIONS

SPIROTOP® SOLAR SPIROVENT® SOLAR



Industry-leading
5-year guarantee

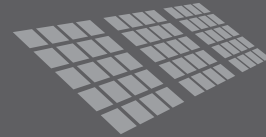

Continuous deaeration
in solar installations



Energy saving



Sturdy brass
housing



Reliable, leak-free
venting system

All images used are for illustrative purposes only. Individual features like material used (i.e. brass or steel) may vary, as may guarantee.

SPIROTOP[®] SOLAR SPIROVENT[®] SOLAR



BENEFITS OF SPIROTECH SOLAR SOLUTIONS

- Removes circulating air and microbubbles effectively
- Removes trapped air
- Greatly reduces commissioning times
- Minimal constant pressure drop
- No unnecessary shutdown
- The special valve seat has a very long life expectancy

SPIROTOP SOLAR/ SPIROVENT SOLAR AUTOMATIC AIR VENTS AND DEAERATORS FOR SOLAR INSTALLATIONS

Air in a solar installation causes complaints, excessive wear, low efficiency and process interruptions. All of these are avoidable by using Spirotech Solar solutions. Furthermore, even the “boil dry” situation of the solar installation can be prevented.

AUTOCLOSE DEARATORS FOR IMPROVED EFFICIENCY

Thanks to a patented invention, Spirotech offers solar deaerators also with an AutoClose function.

As soon as the fluid temperature rises above its boiling point, the deaeration valve closes quickly and completely, preventing the escape of air and steam and thereby the risk of boiling dry of the system.

When the temperature has dropped sufficiently, the valve is reopened for deaeration and the deaeration process is restarted. This means permanent deaeration in the ideal location. Shut-off valves are now redundant.

Thanks to the AutoClose principle, solar installations can remain free of air permanently, increasing system efficiency and preventing all kinds of discomfort and complaints.



Benefits of AutoClose:

- prevents stagnation
- solar fluid will not prematurely degenerate
- system will not boil dry via the deaerator
- no more climbing the roof to deaerate
- permanent air-free, efficient installation
- suitable for new and existing installations

SPIROTOP® SOLAR

Brass solution

SPECIAL

SPIROTOP® SOLAR

Art.-No.	Connection d	int.	H [mm]	b [mm]	B [mm]	D [mm]	y [mm]	e2 [mm]	ext.	Material: housing	Material: float
AB050/008	G½	(F)	112	52	86	65	>50	R½	(M)	Brass	TPX

SPIROTOP® SOLAR – AutoClose

AB050FBA08	G½	(F)	112	52	86	65	>50	R½	(M)	Brass	TPX
------------	----	-----	-----	----	----	----	-----	----	-----	-------	-----



Op. pressure
max. 10 bar



Temperature
max. 180 °C

Note regarding AutoClose Products: Min. 20 % to max. 50 % Glykol

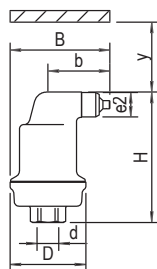

SPIROTOP
SOLAR

SPECIAL

SPIROVENT® SOLAR – Brass solution with vertical connection for high temperature – AutoClose

Art.-No.	Connec- tion d	int.	H [mm]	b [mm]	L [mm]	D [mm]	h [mm]	h1 [mm]	B [mm]	x [mm]	y [mm]	e2 [mm]	ext.	Nom. flow rate [m³/h]	Nom. flow rate [l/s]	Δp at nom. flow [kPa]	Volume [ltr]	Weight [kg]
AA022VFBA08	22 mm	-	218	129	104	65	52	166	150	>50	>50	R½	(M)	1.30	0.35	1.5	0.32	2.0
AA075VFBA08	G¾	(F)	208	129	84	65	42	166	150	>50	>50	R½	(M)	1.30	0.36	1.5	0.32	1.9
AA100VFBA08	G1	(F)	208	129	84	65	42	166	152	>50	>50	R½	(M)	2.00	0.56	2.4	0.32	1.9



Op. pressure
max. 10 bar



Temperature
max. 180 °C

FBA= AutoClose / V= Vertical connection

Note regarding AutoClose Products: Min. 20 % to max. 50 % Glykol

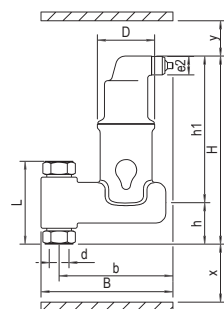

SPIROVENT SOLAR
VERTICAL

SOLAR

SPIROTOP® SOLAR

Brass solution

SPIROVENT® SOLAR – Brass solution with horizontal connection for high temperature – AutoClose

SPECIAL

Art.-No.	Con- nection d	int.	H	b	L	D	h	h1	B	x	y	e2	ext.	Nom. flow rate	Nom. flow rate	Δp at nom. flow	Volume	Weight
			[mm]	[mm]	[mm]	[mm]	[mm]	[mm]	[mm]	[mm]	[mm]	[mm]		[m ³ /h]	[l/s]	[kPa]	[ltr]	[kg]
AA022FBA08	22 mm	-	154	52	105	65	21	133	106	>50	>50	R½	(M)	1.30	0.36	1.3	0.18	1.2
AA075FBA08	G¾	(F)	154	52	85	65	21	133	96	>50	>50	R½	(M)	1.30	0.36	1.3	0.18	1.0
AA100FBA08	G1	(F)	180	52	88	65	35	145	97	>50	>50	R½	(M)	2.00	0.56	1.3	0.21	1.3
AA125FBA08	G1¼	(F)	198	52	88	65	39	159	97	>50	>50	R½	(M)	3.60	1.00	1.3	0.25	1.4
AA150FBA08	G1½	(F)	234	52	88	65	42	192	97	>50	>50	R½	(M)	5.00	1.39	1.3	0.32	1.6



Op. pressure
max. 10 bar



Temperature
max. 180 °C

FBA= AutoClose / V= Vertical connection

Note regarding AutoClose Products: Min. 20 % to max. 50 % Glykol

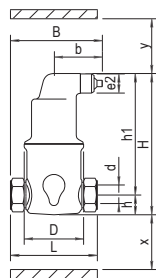

SPIROVENT SOLAR
HORIZONTAL



Have you thought of a dirt separator?
Learn more on page 12.

VACUUM DEGASSERS

SPIROVENT® SUPERIOR



Industry leading
2-year guarantee



Quick and easy
installation



Energy saving



Works perfectly with all
common expansion systems



Protection against
excessive refilling



Significantly reduced
commissioning times

All images used are for illustrative purposes only. Individual features like material used (i.e. brass or steel) may vary, as may guarantee.

SUPERIOR

SPIROVENT® SUPERIOR



BENEFITS OF SPIROVENT SUPERIOR

- Removes all gases, free air, microbubbles and dissolved gases
- Absorptive fluid also ensures the removal of trapped gas bubbles
- Easy installation, which greatly reduces commissioning and handover
- Energy-efficient whilst still achieving the lowest possible gas concentration thanks to SmartSwitch
- Degassed (re)filling and sustained pressure
- Warns before (re)filling becomes excessive
- An extensive range for a wide variety of systems
- Can team up with all common expansion systems
- Two-year guarantee

SPIROVENT SUPERIOR

The SpiroVent Superior is a fully automatic vacuum degasser for heating, cooling and process systems. Because of the fully electronic control system, the Superior offers numerous options for reading system information, status and logged data.

HOW DOES IT WORK?

A pump takes a quantity of system fluid from the circulating flow. Closing a solenoid valve creates a vacuum so that the dissolved gases emerge from the water. These accumulate at the top of the vessel and are released via the air vent. The degassed and absorptive fluid is then returned into the system and will absorb gases again. There are various reasons why gas will always be able to enter a system. Therefore, vacuum degassing is not a one-time process but a continuous requirement.

As soon as any gases are removed, it is registered by the integrated SmartSwitch. If the SmartSwitch has not registered anything for a set amount of time, the SpiroVent Superior detects that the quantity of all gases, including dissolved gases, has reached the minimum value. The degassing process will then stop automatically and start again at the next pre-set time, so the device is only operated when necessary. As a result, energy consumption is kept to a minimum and the life of costly components is extended significantly.



When should a vacuum degasser be used?

- For systems with many branches and a low flow velocity.
- When the system has a small temperature differential.
- When an inline deaerator cannot be installed.
- When it cannot be predicted where gases are released from the water or when that point has a very low flow rate.

SPIROVENT® SUPERIOR

SPIROVENT® SUPERIOR – SpiroVent Superior vacuum degasser for heating and cooling systems

STANDARD

Art.-No.	Type	H	B	D	x	y	con- nection inlet	int.	con- nection outlet	int.	con- nection main- refill	int.	Max. system volume [m³]	Temp. range [°C]	Op. pres- sure [bar]	Weight [kg]	Max. glykol [%]
		[mm]	[mm]	[mm]	[mm]	[mm]											
MV04A50	S400	930	346	334	>600	>600	G¾	(F)	G¾	(F)	-	-	100	0–90	1–4	34	40
MV04B50	S400B	930	346	334	>600	>600	G¾	(F)	G¾	(F)	G¾	(F)	100	0–90	1–4	35	40
MV04R50	S400-R	930	346	334	>600	>600	G¾	(F)	G¾	(F)	G¾	(F)	100	0–90	1–4	34	40
MV06A50	S600	1,020	673	360	>600	>600	G¾	(F)	G¾	(F)	-	-	325	0–90	2.5–6	62	40
MV06B50	S600-B	1,020	673	360	>600	>600	G¾	(F)	G¾	(F)	G¾	(F)	325	0–90	2.5–6	63	40
MV06R50	S600-R	1,020	673	360	>600	>600	G¾	(F)	G¾	(F)	G¾	(F)	325	0–90	2.5–6	64	40
MA10A50	S10A	1,272	744	400	-	-	G¾	(F)	G¾	(F)	-	-	300	0–90	5–10	77	40
MA10R50	S10A-R	1,272	744	400	-	-	G¾	(F)	G¾	(F)	G¾	(F)	300	0–90	5–10	79	40

 Temperature
max. 90 °C

A = Degasser only
B = Break tank
R = Direct refill

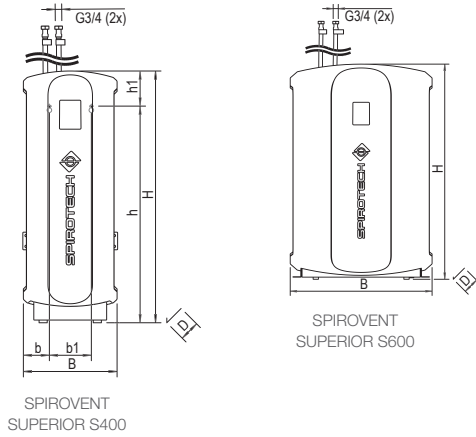

CUSTOM

Please visit page 30 for further information on our custom products.



Have you thought of a dirt separator?
Learn more on page 12.

SUPERIOR

SPIROVENT® SUPERIOR

SPIROVENT® SUPERIOR – SpiroVent Superior vacuum degasser for heating and cooling systems

SPECIAL

Art.-No.	Type	H	B	D	x	y	con- nection inlet	int.	con- nection outlet	int.	con- nection main- refill	int.	Max. system volume [m³]	Temp. range [°C]	Op. pres- sure [bar]	Weight [kg]	Max. glykol [%]
		[mm]	[mm]	[mm]	[mm]	[mm]											
MV04A50I	S400-I	930	346	334	>600	>600	G¾	(F)	G¾	(F)	-	-	100	0-90	1-4	34	40
MV04B50I	S400-BI	930	346	334	>600	>600	G¾	(F)	G¾	(F)	G¾	(F)	100	0-90	1-4	35	40
MV04R50I	S400-RI	930	346	334	>600	>600	G¾	(F)	G¾	(F)	G¾	(F)	100	0-90	1-4	34	40
MV06A50I	S600-I	1,020	673	360	>600	>600	G¾	(F)	G¾	(F)	-	-	325	0-90	2.5-6	62	40
MV06B50I	S600-BI	1,020	673	360	>600	>600	G¾	(F)	G¾	(F)	G¾	(F)	325	0-90	2.5-6	65	40
MV06R50I	S600-RI	1,020	673	360	>600	>600	G¾	(F)	G¾	(F)	G¾	(F)	325	0-90	2.5-6	63	40
MV06A60	S600	1,020	673	360	>600	>600	G¾	(F)	G¾	(F)	-	-	325	0-90	2.5-6	62	40
MV06B60	S600-B	1,020	673	360	>600	>600	G¾	(F)	G¾	(F)	G¾	(F)	325	0-90	2.5-6	64	40
MV06R60	S600-R	1,020	673	360	>600	>600	G¾	(F)	G¾	(F)	G¾	(F)	325	0-90	2.5-6	63	40
MV06A60I	S600-I	1,020	673	360	>600	>600	G¾	(F)	G¾	(F)	-	-	325	0-90	2.5-6	62	40
MV06B60I	S600-BI	1,020	673	360	>600	>600	G¾	(F)	G¾	(F)	G¾	(F)	325	0-90	2.5-6	65	40
MV06R60I	S600-RI	1,020	673	360	>600	>600	G¾	(F)	G¾	(F)	G¾	(F)	325	0-90	2.5-6	63	40
MA10A50I	S10AI	1,272	744	400	-	-	G¾	(F)	G¾	(F)	-	-	300	0-90	5-10	79	40
MA10R50I	S10A-RI	1,272	744	400	-	-	G¾	(F)	G¾	(F)	G¾	(F)	300	0-90	5-10	81	40
MA16A50	S16A	1,272	744	400	-	-	G¾	(F)	G¾	(F)	-	-	300	0-90	9-16	82	40
MA16R50	S16A-R	1,272	744	400	-	-	G¾	(F)	G¾	(F)	G¾	(F)	300	0-90	9-16	90	40
MA16A50I	S16AI	1,272	744	400	-	-	G¾	(F)	G¾	(F)	-	-	300	0-90	9-16	92	40
MA16R50I	S16A-RI	1,272	744	400	-	-	G¾	(F)	G¾	(F)	G¾	(F)	300	0-90	9-16	92	40



A = Degasser only
B = Break tank
R = Direct refill
I = Insulated

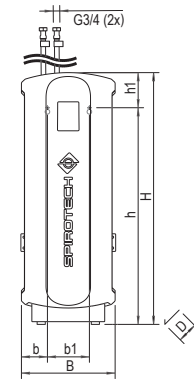

SPIROVENT
SUPERIOR S400

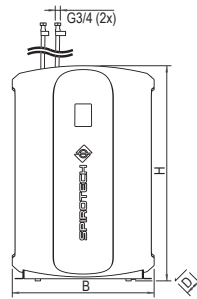

SPIROVENT
SUPERIOR S600



Have you thought of a dirt separator?
Learn more on page 12.

CUSTOM

Please visit page 30 for further information on our custom products.

Art.-No.	Description	Suitable for
G60.638	Self-dosing package for SpiroVent Superior	Fill and S4
G60.639	Self-dosing package for SpiroVent Superior	S6 and S10
G60.640	Self-dosing package for SpiroVent Superior	Standalone product
G60.649	Dosing pump 3.9 l/h–7 bar	G60.638
G60.650	Dosing pump 4.8 l/h–10 bar	G60.639
G32.116	Dosing container 60 l	G60.638/G60.639/G60.640
G60.653	Injection valve (RVS)	G60.638/G60.639/G60.640
G60.775	Foot valve	G60.638/G60.639/G60.640
G32.020	Level sensor incl. 3 m cable	G60.638/G60.639/G60.640
G32.030	Connectors, 4 PIN connectors	G60.638/G60.639/G60.640
G60.776	Connectors incl. cable, 4 PIN connectors incl. 2 m cable	G60.640
G60.777	Connectors, 5 PIN connectors	G60.638/G60.639/G60.640
G60.773	Tube	G60.638/G60.639/G60.640
G60.641	Water meters excl. slope link, DN 20 30° C 1" external thread	G60.638/G60.639/G60.640
G60.642	Water meters, accessory, 1" internal thread to ½" external thread	G60.638/G60.639/G60.640
G60.643	Water meters, accessory, 1" internal thread to ¾" external thread	G60.638/G60.639/G60.640
G60.648	Basic module water softener	G60.638/G60.639/G60.640
G60.644	Cartridge 4 l (14.560 l/°dH)*	G60.638/G60.639/G60.640
G60.645	Cartridge 7 l (25.480 l/°dH)*	G60.638/G60.639/G60.640
G60.646	Cartridge 14 l (50.960 l/°dH)*	G60.638/G60.639/G60.640
G60.647	Cartridge 30 l (109.200 l/°dH)*	G60.638/G60.639/G60.640
TMA05	Backflow preventer with controllable low pressure zone (½" IG)	Products with automatic refill
TMA06	Backflow preventer with controllable low pressure zone (¾" IG)	Products with automatic refill

PARTICLE AND DIRT SEPARATORS

SPIROTRAP®



Industry leading
up to 20-years guarantee



High-efficient
dirt separation



Energy saving



Safe, high-powered
magnet



Constant,
low pressure drop



Quick and easy
cleaning



All images used are for illustrative purposes only. Individual features like material used (i.e. brass or steel) may vary, as may guarantee.

SPIROTRAP®



BENEFITS OF SPIROTRAP

- Very small particles, from 5 µm (= 0.005 mm) are separated and removed
- Dirt can be drained while the system is in operation
- No shut-off valves or bypass required
- Constant low pressure drop
- Maintenance only takes a few seconds and is not a dirty job compared to a filter solution
- No unnecessary downtime
- Connection diameters from ¾" to DN 800 (see page 30 for additional options)
- A complete range, suitable for various pressures and temperatures

SPIROTRAP PARTICLE AND DIRT SEPARATORS

Today's highly energy-efficient heating and cooling systems can only offer optimal performance with dirt-free water. In untreated systems, dirt can accumulate in multiple places throughout the system. Studies and practical experience show that magnetite in particular, leads to greatly reduced energy efficiency and therefore higher energy costs. Ensuring quick and efficient dirt removal is essential. Spirotech offers an extensive range of SpiroTrap dirt separators from small brass solutions to heavy duty steel units, specifically designed for the removal of dirt.

AVAILABLE VERSIONS:

- Normal flow brass (designed for a nominal flow velocity up to 1 m/s)
- Normal flow steel (designed for a nominal flow velocity up to 1.5 m/s)
- Hi-flow (designed for a nominal flow velocity up to 3 m/s)
- Magnetic (separators with internal or external magnet)
- Demountable (If the level of contamination is such that it needs to be possible to replace or clean the separating element).



MAXIMISING PERFORMANCE – PROTECT COMPONENTS WITH SPIROTRAP MB3/MBL

The unique magnetic field booster technology guarantees fast and optimal dirt separation. Beside non-magnetic dirt even the smallest magnetite particles are removed, maximising system performance as well as protecting costly system components.

Thanks to the ingenious design, collected dirt can be removed quickly and easily. The sturdy brass SpiroTrap MB3 and SpiroTrap MBL are equipped with a swivel connection that makes them very easy to install and suitable for horizontal, vertical and even diagonal pipes. The units with compression couplings have a unique slide-over installation, allowing for quick and easy installation in existing systems.

For connections from 1¼" up to 2", we offer the SpiroTrap MBL. For even larger applications, we recommend our SpiroTrap Magnet (in steel).

Kiwa GASTEC has objectively proven that Spirotech's SpiroTrap MB3, which maximises magnetite removal, can bring up to 7.4% energy savings.



SPIROTRAP®

Brass solution

SPIROTRAP® MBC – Brass solution with universal connection

Art.-No.	Con- nection d	int.	Hv	Hh	D	L	M	Nom. flow rate	Nom. flow rate	Δp at nom. flow	Volume	Weight
			[mm]	[mm]	[mm]	[mm]	[mm]	[m³/h]	[l/s]	[kPa]	[ltr]	[kg]
UE022WH	22 mm	-	150	121	73	120	110	1,30	0,36	2,1	0,2	1,4
UE028WH	28 mm	-	150	121	83	120	121	2,00	0,56	3,8	0,3	1,6
UE075WH	G¾	(F)	140	121	73	100	112	1,30	0,36	2,1	0,2	1,4
UE100WH	G1	(F)	140	121	83	100	124	2,00	0,56	3,8	0,3	1,6



Op. pressure
max. 10 bar



Temperature
max. 110 °C



Nom. flow velocity
1 m/s



with magnet

SPIROTRAP® MB3/MBL – Brass solution with universal connection

Art.-No.	Con- nection d	int.	Hv	Hh	D	L	b	B	h	h1	x	y	e	ext.	Nom. flow rate	Nom. flow rate	Δp at nom. flow	Volume	Weight
			[mm]	[mm]	[mm]	[mm]	[mm]	[mm]	[mm]	[mm]	[mm]	[mm]	[mm]	[mm]	[m³/h]	[l/s]	[kPa]	[ltr]	[kg]
UE022WJ	22 mm	-	177	149	84	112	123	141	117	32	>110	>50	G¾	(M)	1.30	0.36	2.1	0.4	2.2
UE028WJ	28 mm	-	177	149	84	112	127	149	117	32	>110	>50	G¾	(M)	2.00	0.56	3.8	0.4	2.3
UE075WJ	G¾	(F)	162	149	84	90	125	142	117	32	>110	>50	G¾	(M)	1.30	0.36	2.1	0.4	2.2
UE100WJ	G1	(F)	162	149	84	90	129	152	117	32	>110	>50	G¾	(M)	2.00	0.56	3.8	0.4	2.3
UE125WJ	Rp1¼	(F)	224	210	84	128	138	163	160	50	>110	>50	G¾	(M)	3.60	1.00	2.2	0.8	3.6
UE150WJ	Rp1½	(F)	224	210	84	128	141	168	160	50	>110	>50	G¾	(M)	5.00	1.39	2.6	0.8	3.7
UE200WJ	Rp2	(F)	224	210	84	128	148	183	160	50	>110	>50	G¾	(M)	7.50	2.08	5.8	0.8	3.9



Op. pressure
max. 10 bar



Temperature
max. 110 °C



Nom. flow velocity
1 m/s



with magnet

SPIROTRAP® – Brass solution with horizontal connection

Art.-No.	Con- nection d	int.	H	D	L	b	B	h	h1	x	y	e	ext.	Nom. flow rate	Nom. flow rate	Δp at nom. flow	Volume	Weight
			[mm]	[mm]	[mm]	[mm]	[mm]	[mm]	[mm]	[mm]	[mm]	[mm]	[mm]	[m³/h]	[l/s]	[kPa]	[ltr]	[kg]
AE022	22 mm	-	118	65	106	-	-	96	22	>70	>50	G¾	(M)	1.30	0.36	1.3	0.2	1.2
AE075	G¾	(F)	118	65	85	-	-	96	22	>70	>50	G¾	(M)	1.30	0.36	1.3	0.2	1.0
AE100	G1	(F)	143	65	88	-	-	108	35	>70	>50	G¾	(M)	2.00	0.56	1.3	0.2	1.3
AE125	G1¼	(F)	161	65	88	-	-	122	39	>70	>50	G¾	(M)	3.60	1.00	1.3	0.3	1.4
AE150	G1½	(F)	197	65	88	-	-	155	42	>70	>50	G¾	(M)	5.00	1.39	1.3	0.3	1.6
AE200	G2	(F)	240	65	132	-	-	180	60	>70	>50	G¾	(M)	7.50	2.08	1.4	1.1	3.9

SPIROTRAP® – Brass solution with vertical connection

AE022V	22 mm	-	182	65	104	121	142	130	52	>70	>30	G¾	(M)	1,30	0,36	1,5	0,3	2,0
AE075V	G¾	(F)	172	65	84	121	142	130	42	>70	>30	G¾	(M)	1,30	0,36	1,5	0,3	1,9
AE100V	G1	(F)	172	65	84	121	144	130	42	>70	>30	G¾	(M)	2,00	0,56	2,4	0,3	1,9



Op. pressure
max. 10 bar



Temperature
max. 110 °C



Nom. flow velocity
1 m/s



without magnet

V = Vertical connection

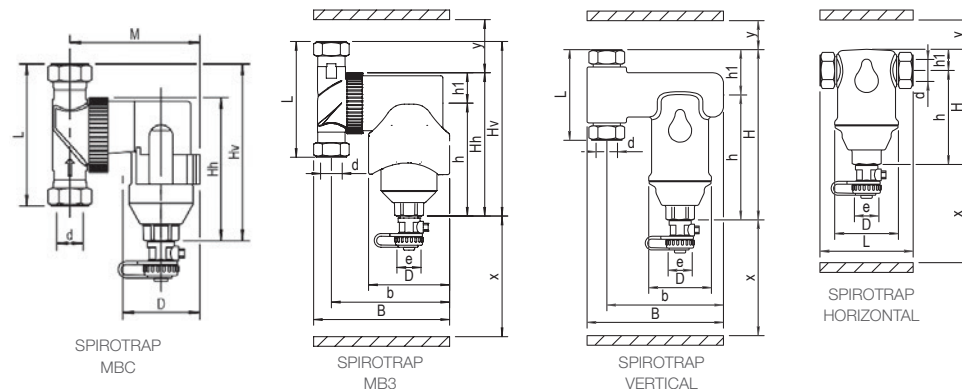

Have you thought of an automatic air vent (AAV) and microbubble deaeration? Learn more on page 14.

CUSTOM

Please visit page 30 for further information on our custom products.

SPIROTRAP®

Brass solution

ACCESSORIES

SPIROTRAP® – Accessories for brass solution

Art.-No.	Description	Suitable for
TAR200	Insulation Set SpiroTrap for 2" horizontal connection	AE200
TAR100V	Insulation Set SpiroTrap for vertical connection	AE022V, AE075V, AE100V
TAE150	Insulation Set SpiroTrap for horizontal connection	AE022, AE075, AE100, AE125, AE150
TUR100	Insulation Set SpiroTrap MB3 for universal connection	UE022WJ, UE028WJ, UE075WJ, UE100WJ
TUR125	Insulation Set SpiroTrap G1¼	UE125WJ
TUR150	Insulation Set SpiroTrap G1½	UE150WJ
TUR200	Insulation Set SpiroTrap G2	UE200WJ

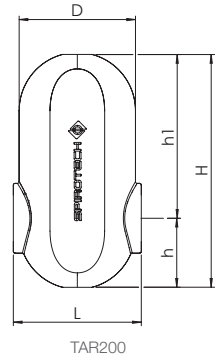

SPIROTRAP®

Steel solution

STANDARD

SPIROTRAP® – Steel solution with magnet – standard flow

Art.-No.	DN	OD	H	H1	D	L/LF	h	h1	x	y	e	int.	Nom. flow rate	Nom. flow rate	Δp at nom. flow	Volume	Weight
		[mm]	[mm]	[mm]	[mm]	[mm]	[mm]	[mm]	[mm]	[mm]			[m³/h]	[l/s]	[kPa]	[litr]	[kg]
BE050LM	50	60.3	405	465	159	260	276	121	>330	>50	Rp1	(F)	12.50	3.47	3.0	5.0	8.0
BE050FM	50	60.3	405	465	159	350	276	121	>330	>50	Rp1	(F)	12.50	3.47	3.0	5.0	13.0
BE065LM	65	76.1	405	465	159	260	268	129	>330	>50	Rp1	(F)	20.00	5.56	2.9	5.0	8.0
BE065FM	65	76.1	405	465	159	350	268	129	>330	>50	Rp1	(F)	20.00	5.56	2.9	5.0	14.0
BE080LM	80	88.9	525	590	219	370	374	148	>370	>50	Rp1	(F)	27.00	7.50	3.1	17.0	16.0
BE080FM	80	88.9	525	590	219	470	374	148	>370	>50	Rp1	(F)	27.00	7.50	3.1	17.0	24.0
BE100LM	100	114.3	525	590	219	370	362	160	>370	>50	Rp1	(F)	47.00	13.06	3.7	17.0	16.0
BE100FM	100	114.3	525	590	219	475	362	160	>370	>50	Rp1	(F)	47.00	13.06	3.7	17.0	25.0
BE125LM	125	139.7	745	815	324	525	555	193	>540	>50	Rp1	(F)	72.00	20.00	4.2	50.0	47.0
BE125FM	125	139.7	745	815	324	635	555	193	>540	>50	Rp1	(F)	72.00	20.00	4.2	50.0	58.0
BE150LM	150	168.3	745	815	324	525	541	207	>540	>50	Rp1	(F)	108.00	30.00	4.9	50.0	48.0
BE150FM	150	168.3	745	815	324	635	541	207	>540	>50	Rp1	(F)	108.00	30.00	4.9	50.0	61.0
BE200FM	200	219.1	1,015	1,080	406	775	732	280	>700	>50	Rp1	(F)	180.00	50.00	5.8	105.0	107.0
BE250FM	250	273.0	1,210	1,280	508	890	847	364	>750	>50	Rp2	(F)	288.00	80.00	7.0	210.0	162.0
BE300FM	300	323.9	1,435	1,500	610	1,005	1,008	426	>900	>50	Rp2	(F)	405.00	112.50	7.8	350.0	261.0

Op. pressure
max. 10 bar

Temperature
max. 110 °C

Nom. flow velocity
1.5 m/s

with Magnet

L = Weld ends / F = Flange design (PN 16) / M = Magnet

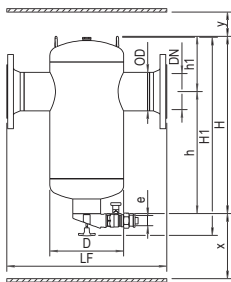

SPIROTRAP
FLANGE DESIGN

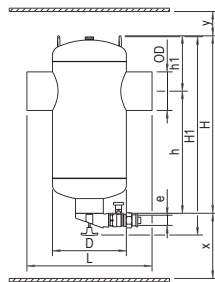

SPIROTRAP
WELD ENDS

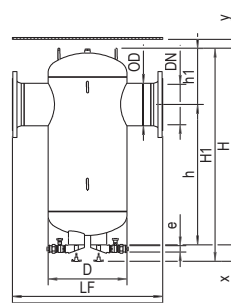

SPIROTRAP
FLANGE DESIGN
FROM DN 200



Have you also thought of an automatic air vent/microbubble separator? Learn more on page 14.

SPIROTRAP®

Steel solution

STANDARD SPIROTRAP® – Steel solution without magnet – standard flow

Art.-No.	DN	OD	H	D	L/LF	h	h1	x	y	e	int.	Nom. flow rate	Nom. flow rate	Δp at nom. flow	Volume	Weight
												[m³/h]	[l/s]			
BE050L	50	60.3	390	159	260	270	121	>200	>50	Rp1	(F)	12.50	3.47	3.0	5.0	9.0
BE050F	50	60.3	390	159	350	270	121	>200	>50	Rp1	(F)	12.50	3.47	3.0	5.0	13.0
BE065L	65	76.1	390	159	260	260	129	>200	>50	Rp1	(F)	20.00	5.56	2.7	5.0	9.0
BE065F	65	76.1	390	159	350	260	129	>200	>50	Rp1	(F)	20.00	5.56	2.7	5.0	15.0
BE080L	80	88.9	500	219	370	355	148	>200	>50	Rp1	(F)	27.00	7.50	2.9	17.0	17.0
BE080F	80	88.9	500	219	470	355	148	>200	>50	Rp1	(F)	27.00	7.50	2.9	17.0	25.0
BE100L	100	114.3	500	219	370	345	160	>200	>50	Rp1	(F)	47.00	13.06	3.7	17.0	17.0
BE100F	100	114.3	500	219	475	345	160	>200	>50	Rp1	(F)	47.00	13.06	3.7	17.0	26.0
BE125L	125	139.7	670	324	525	475	193	>200	>50	Rp1	(F)	72.00	20.00	4.2	50.0	41.0
BE125F	125	139.7	670	324	635	475	193	>200	>50	Rp1	(F)	72.00	20.00	4.2	50.0	54.0
BE150L	150	168.3	670	324	525	460	207	>200	>50	Rp1	(F)	108.00	30.00	4.9	50.0	42.0
BE150F	150	168.3	670	324	635	460	207	>200	>50	Rp1	(F)	108.00	30.00	4.9	50.0	56.0
BE200F	200	219.1	900	406	775	615	280	>200	>50	Rp1	(F)	180.00	50.00	5.8	105.0	105.0
BE250F	250	273.0	1,165	508	890	800	364	>200	>50	Rp2	(F)	288.00	80.00	6.9	210.0	170.0
BE300F	300	323.9	1,380	610	1,005	955	426	>200	>50	Rp2	(F)	405.00	112.50	7.7	350.0	252.0



Op. pressure
max. 10 bar



Temperature
max. 110 °C



Nom. flow velocity
1.5 m/s



without magnet

Products in the range are available up to DN800 and are made to order – prices on application.

L = Weld ends / F = Flange design (PN 16)

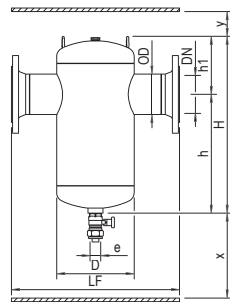

SPIROTRAP
FLANGE DESIGN

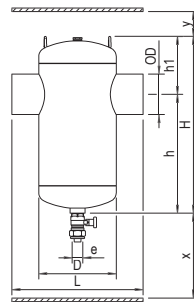

SPIROTRAP
WELD ENDS

SPIROTRAP®

Steel solution

SPIROTRAP® – Demountable steel solution without magnet – standard flow

SPECIAL

Art.-No.	DN	OD	H	D	L/LF	DF	h	h1	x	y	e	int.	Nom. flow rate	Nom. flow rate	Δp at nom. flow	Volume	Weight
		[mm]	[mm]	[mm]	[mm]	[mm]	[mm]	[mm]	[mm]	[mm]	[mm]		[m³/h]	[l/s]	[kPa]	[ltr]	[kg]
BF050L	50	60.3	390	159	260	285	270	121	>350	>50	Rp1	(F)	12.50	3.47	3.0	5.0	28.0
BF050F	50	60.3	390	159	350	285	270	121	>350	>50	Rp1	(F)	12.50	3.47	3.0	5.0	33.0
BF065L	65	76.1	390	159	260	285	260	129	>350	>50	Rp1	(F)	20.00	5.56	2.7	5.0	28.0
BF065F	65	76.1	390	159	350	285	260	129	>350	>50	Rp1	(F)	20.00	5.56	2.7	5.0	34.0
BF080L	80	88.9	500	219	370	340	355	148	>500	>50	Rp1	(F)	27.00	7.50	2.9	17.0	40.0
BF080F	80	88.9	500	219	470	340	355	148	>500	>50	Rp1	(F)	27.00	7.50	2.9	17.0	48.0
BF100L	100	114.3	500	219	370	340	345	160	>500	>50	Rp1	(F)	47.00	13.06	3.7	17.0	40.0
BF100F	100	114.3	500	219	475	340	345	160	>500	>50	Rp1	(F)	47.00	13.06	3.7	17.0	50.0
BF125L	125	139.7	670	324	525	460	475	193	>600	>50	Rp1	(F)	72.00	20.00	4.2	50.0	90.0
BF125F	125	139.7	670	324	635	460	475	193	>600	>50	Rp1	(F)	72.00	20.00	4.2	50.0	103.0
BF150L	150	168.3	670	324	525	460	460	207	>600	>50	Rp1	(F)	108.00	30.00	4.9	50.0	90.0
BF150F	150	168.3	670	324	635	460	460	207	>600	>50	Rp1	(F)	108.00	30.00	4.9	50.0	106.0
BF200F	200	219.1	900	406	775	580	615	280	>900	>50	Rp1	(F)	180.00	50.00	5.8	105.0	195.0
BF250F	250	273.0	1,165	508	890	715	800	364	>1,100	>50	Rp2	(F)	288.00	80.00	6.9	210.0	319.0
BF300F	300	323.9	1,380	610	1,005	840	955	426	>1,300	>50	Rp2	(F)	405.00	112.50	7.7	350.0	499.0

 Op. pressure
max. 10 bar

 Temperature
max. 110 °C

 Nom. flow velocity
1.5 m/s

 without magnet

L = Weld ends / F = Flange design (PN 16)

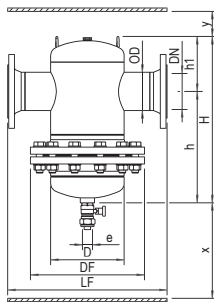

SPIROTRAP
DEMOUNTABLE
FLANGE DESIGN

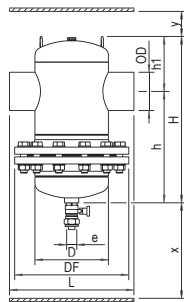

SPIROTRAP
DEMOUNTABLE
WELD ENDS

CUSTOM

Please visit page 30 for further information on our custom products.

SPIROTRAP®

Steel solution

SPIROTRAP® – Steel solution without magnet – Hi-flow

SPECIAL

Art.-No.	DN	OD	H	D	L/LF	h	h1	x	y	e	int.	Nom. flow rate	Nom. flow rate	Δp at nom. flow	Volume	Weight
		[mm]	[mm]	[mm]	[mm]	[mm]	[mm]	[mm]	[mm]			[m ³ /h]	[l/s]	[kPa]	[ltr]	[kg]
HE050L	50	60,3	550	159	260	430	121	>200	>50	Rp1	(F)	25,00	6,94	11,7	7,0	12,0
HE050F	50	60,3	550	159	350	430	121	>200	>50	Rp1	(F)	25,00	6,94	11,7	7,0	17,0
HE065L	65	76,1	550	159	260	420	129	>200	>50	Rp1	(F)	40,00	11,11	11,9	7,0	12,0
HE065F	65	76,1	550	159	350	420	129	>200	>50	Rp1	(F)	40,00	11,11	11,9	7,0	18,0
HE080L	80	88,9	700	219	370	550	148	>200	>50	Rp1	(F)	54,00	15,00	12,4	25,0	23,0
HE080F	80	88,9	700	219	470	550	148	>200	>50	Rp1	(F)	54,00	15,00	12,4	25,0	31,0
HE100L	100	114,3	700	219	370	540	160	>200	>50	Rp1	(F)	94,00	26,11	14,7	25,0	24,0
HE100F	100	114,3	700	219	475	540	160	>200	>50	Rp1	(F)	94,00	26,11	14,7	25,0	33,0
HE125L	125	139,7	950	324	525	755	193	>200	>50	Rp1	(F)	144,00	40,00	16,9	75,0	58,0
HE125F	125	139,7	950	324	635	755	193	>200	>50	Rp1	(F)	144,00	40,00	16,9	75,0	71,0
HE150L	150	168,3	950	324	525	740	207	>200	>50	Rp1	(F)	215,00	59,72	19,2	75,0	59,0
HE150F	150	168,3	950	324	635	740	207	>200	>50	Rp1	(F)	215,00	59,72	19,2	75,0	73,0
HE200F	200	219,1	1.240	406	775	955	280	>200	>50	Rp1	(F)	360,00	100,00	23,4	150,0	136,0
HE250F	250	273,0	1.670	508	890	1.300	364	>200	>50	Rp2	(F)	575,00	159,72	27,5	300,0	213,0
HE300F	300	323,9	1.980	610	1.005	1.550	426	>200	>50	Rp2	(F)	810,00	225,00	31,2	500,0	393,0



Op. pressure
max. 10 bar



Temperature
max. 110 °C



Nom. flow velocity
3 m/s



without Magnet

Products in the range are available up to DN800 and are made to order – prices on application.

L = Weld ends / F = Flange design (PN 16)

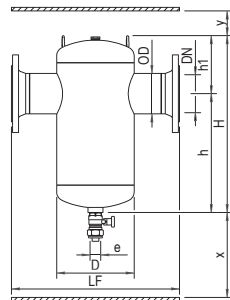

SPIROTRAP
FLANGE DESIGN

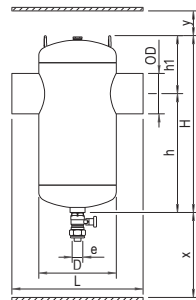

SPIROTRAP
WELD ENDS

CUSTOM

Please visit page 30 for further information on our custom products.

SPIROTRAP®

Steel solution

SPIROTRAP® – Demountable steel solution without magnet – Hi-flow

SPECIAL

Art.-No.	DN	OD	H	D	L/LF	DF	h	h1	x	y	e	int.	Nom. flow rate	Nom. flow rate	Δp at nom. flow	Volume	Weight
		[mm]	[mm]	[mm]	[mm]	[mm]	[mm]	[mm]	[mm]	[mm]	[mm]		[m³/h]	[l/s]	[kPa]	[ltr]	[kg]
HF050L	50	60,3	550	159	260	285	430	121	>500	>50	Rp1	(F)	25,00	6,94	11,7	7,0	30,0
HF050F	50	60,3	550	159	350	285	430	121	>500	>50	Rp1	(F)	25,00	6,94	11,7	7,0	35,0
HF065L	65	76,1	550	159	260	285	420	129	>500	>50	Rp1	(F)	40,00	11,11	11,9	7,0	30,0
HF065F	65	76,1	550	159	350	285	420	129	>500	>50	Rp1	(F)	40,00	11,11	11,9	7,0	36,0
HF080L	80	88,9	700	219	370	340	550	148	>700	>50	Rp1	(F)	54,00	15,00	12,4	25,0	50,0
HF080F	80	88,9	700	219	470	340	550	148	>700	>50	Rp1	(F)	54,00	15,00	12,4	25,0	58,0
HF100L	100	114,3	700	219	370	340	540	160	>700	>50	Rp1	(F)	94,00	26,11	14,7	25,0	50,0
HF100F	100	114,3	700	219	475	340	540	160	>700	>50	Rp1	(F)	94,00	26,11	14,7	25,0	60,0
HF125L	125	139,7	950	324	525	460	755	193	>900	>50	Rp1	(F)	144,00	40,00	16,9	75,0	110,0
HF125F	125	139,7	950	324	635	460	755	193	>900	>50	Rp1	(F)	144,00	40,00	16,9	75,0	123,0
HF150L	150	168,3	950	324	525	460	740	207	>900	>50	Rp1	(F)	215,00	59,72	19,2	75,0	110,0
HF150F	150	168,3	950	324	635	460	740	207	>900	>50	Rp1	(F)	215,00	59,72	19,2	75,0	126,0
HF200F	200	219,1	1.240	406	775	580	955	280	>1.200	>50	Rp1	(F)	360,00	100,00	23,4	150,0	225,0
HF250F	250	273,0	1.670	508	890	715	1.300	364	>1.600	>50	Rp2	(F)	575,00	159,72	27,5	300,0	380,0
HF300F	300	323,9	1.980	610	1.005	840	1.550	426	>1.900	>50	Rp2	(F)	810,00	225,00	31,2	500,0	599,0

Op. pressure
max. 10 bar

Temperature
max. 110 °C

Nom. flow velocity
3 m/s

without Magnet

L = Weld ends / F = Flange design (PN 16)

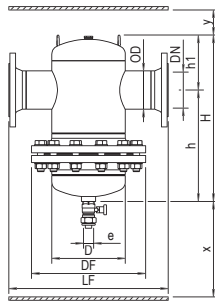

SPIROTRAP
DEMOUNTABLE
FLANGE DESIGN

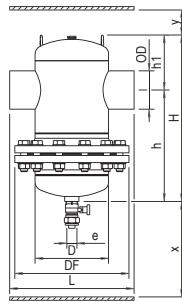

SPIROTRAP
DEMOUNTABLE
WELD ENDS

ACCESSORIES

SPIROTRAP® – Accessories for steel solution

Art.-No.	Description	Suitable for
TB050	Insulation Set for SpiroTrap DN 50 + 65	BE050F/L, BE065F/L, BE050FM/LM, BE065FM/LM
TB080	Insulation Set for SpiroTrap DN 80 + 100	BE080F/L, BE100F/L, BE080FM/LM, BE100FM/LM
TB125	Insulation Set for SpiroTrap DN 125 + 150	BE125F/L, BE150F/L
TB125A01	Insulation Set for SpiroTrap Magnet DN 125 + 150	BE125FM/LM, BE150FM/LM

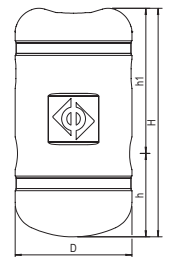

SPIROTRAP
INSULATION

CUSTOM

Please visit page 30 for further information on our custom products.

DEAERATORS AND DIRT SEPARATORS

SPIROCOMBI®



Industry leading
up to 20-year guarantee



Energy saving



Highly efficient
air and dirt removal



Quick, easy cleaning



Unique, high-powered
magnet



Protects critical
system components

All images used are for illustrative purposes only. Individual features like material used (i.e. brass or steel) may vary, as may guarantee.

SPIROCOMBI®



BENEFITS OF SPIROCOMBI

- Removes circulating air and microbubbles effectively
- Very small particles, from 5 µm (= 0.005 mm), are separated and removed
- Dirt can be discharged while the system is in operation
- No shut-off valves or bypass required
- Constant low pressure drop
- Exceptional guarantee

SPIROCOMBI DEAERATORS AND DIRT SEPARATORS

Today's highly energy-efficient heating and cooling systems offer optimal performance with water that is free of air and dirt. In untreated systems, air may cause problems such as flow interruptions or even a complete system failure. Dirt consists mainly of magnetite, that can accumulate wherever a magnetic field is present. In valves or heat exchangers, pipes, radiators, pumps and calorimeters. Next to costs associated with repairs, parts and downtime, contamination also leads to reduced system performance and, therefore, higher energy costs.

Spirotech offers an extensive range of SpiroCombi deaerators/dirt separators, especially designed for the simultaneous removal of air and dirt. These remove air, microbubbles and dirt particles from system water continuously.

EFFECTIVE, SAFE, COMPACT AND EASY TO USE

System characteristics determine the best option; two individual separators or a single combined unit. For the fastest removal of magnetite, SpiroCombi Magnet has been added to the existing range of combined air and dirt separators.

The Spirotube separation element ensures effective separation of air and dirt with a minimal pressure drop. The reliable venting mechanism is leak-free and guarantees effective deaeration. The dry pocket magnet increases the magnetite removal substantially and features an excellent first pass efficiency. Collected dirt can be removed quickly, easily and without mess using a drag mechanism. The easy-to-clean magnet resides safely inside the unit and always remains correctly mounted. The robust device's compact design means minimal height is required for installation.



SPIROCOMBI®

Brass solution

SPIROCOMBI® MB3 – Brass solution with magnet and universal connection

STANDARD

Art.-No.	Connection d	H	b	B	L	D	h	h1	e2	x	y	Nom. flow rate	Nom. flow rate	Volume	Weight
		[mm]	[mm]	[mm]	[mm]	[mm]	[mm]	[mm]	[mm]	[mm]	[mm]	[m ³ /h]	[l/s]	[ltr]	[kg]
UC022WJ	22 mm	272	123	141	120	84	123	149	R½	>100	>75	1.3	0.36	0.53	2.49
UC028WJ	28 mm	272	126	149	120	84	123	149	R½	>100	>75	2.0	0.55	0.53	2.60
UC075WJ	G¾	272	125	142	100	84	123	149	R½	>100	>75	1.3	0.36	0.53	2.41
UC100WJ	G1	272	129	152	100	84	123	149	R½	>100	>75	2.0	0.55	0.53	2.57
UC125WJ	G1¼	406	138	162	128	84	174	232	R½	>100	>75	3.6	1.00	1.47	5.20
UC150WJ	G1½	406	141	168	128	84	174	232	R½	>100	>75	5.0	1.38	1.52	5.30
UC200WJ	G2	406	148	183	128	84	174	232	R½	>100	>75	7.5	2.08	1.61	5.40



Op. pressure
max. 10 bar



Temperature
max. 110 °C



Nom. flow velocity
1 m/s



with magnet

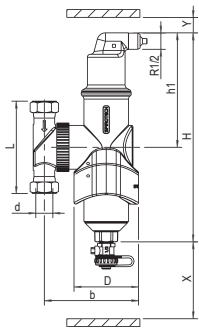

SPIROCOMBI
MB3

SPIROCOMBI® – Steel solution with magnet – standard flow

STANDARD

Art.-No.	DN	OD	H	h1	h	D	L/LF	H1	e1	ext.	e	int.	e2	ext.	x	y	Nom. flow rate	Nom. flow rate	Δp at nom. flow	Volume	Weight
		[mm]	[mm]	[mm]	[mm]	[mm]	[mm]	[mm]							[mm]	[mm]	[m³/h]	[l/s]	[kPa]	[ltr]	[kg]
BC050LM	50	60.3	647	361	286	159	260	750	G¾	(M)	Rp1	(F)	R½	(M)	>330	>50	12.50	3.47	3.0	7.0	12.0
BC050FM	50	60.3	647	361	286	159	350	750	G¾	(M)	Rp1	(F)	R½	(M)	>330	>50	12.50	3.47	3.0	7.0	16.0
BC065LM	65	76.1	647	361	286	159	260	750	G¾	(M)	Rp1	(F)	R½	(M)	>330	>50	20.00	5.56	2.9	7.0	12.0
BC065FM	65	76.1	647	361	286	159	350	750	G¾	(M)	Rp1	(F)	R½	(M)	>330	>50	20.00	5.56	2.9	7.0	18.0
BC080LM	80	88.9	808	433	375	219	370	910	G¾	(M)	Rp1	(F)	R½	(M)	>370	>50	27.00	7.50	3.1	25.0	24.0
BC080FM	80	88.9	808	433	375	219	470	910	G¾	(M)	Rp1	(F)	R½	(M)	>370	>50	27.00	7.50	3.1	25.0	31.0
BC100LM	100	114.3	808	433	375	219	370	910	G¾	(M)	Rp1	(F)	R½	(M)	>370	>50	47.00	13.06	3.7	25.0	24.0
BC100FM	100	114.3	808	433	375	219	475	910	G¾	(M)	Rp1	(F)	R½	(M)	>370	>50	47.00	13.06	3.7	25.0	32.0
BC125LM	125	139.7	1,100	560	540	324	525	1,200	G¾	(M)	Rp1	(F)	R½	(M)	>540	>50	72.00	20.00	4.2	75.0	59.0
BC125FM	125	139.7	1,100	560	540	324	635	1,200	G¾	(M)	Rp1	(F)	R½	(M)	>540	>50	72.00	20.00	4.2	75.0	71.0
BC150LM	150	168.3	1,100	560	540	324	525	1,200	G¾	(M)	Rp1	(F)	R½	(M)	>540	>50	108.00	30.00	4.9	75.0	59.0
BC150FM	150	168.3	1,100	560	540	324	635	1,200	G¾	(M)	Rp1	(F)	R½	(M)	>540	>50	108.00	30.00	4.9	75.0	74.0
BC200FM	200	219.1	1,429	705	724	406	775	1,530	G¾	(M)	Rp1	(F)	R½	(M)	>700	>50	180.00	50.00	5.8	150.0	133.0
BC250FM	250	273.0	1,756	909	847	508	890	1,860	G¾	(M)	Rp1	(F)	R½	(M)	>750	>50	288.00	80.00	7.0	300.0	197.0
BC300FM	300	323.9	2,070	1,062	1,008	610	1,005	2,170	G¾	(M)	Rp1	(F)	R½	(M)	>900	>50	405.00	112.50	7.8	500.0	319.0

Op. pressure
max. 10 bar

Temperature
max. 110 °C

Nom. flow velocity
1.5 m/s

with magnet

L= Weld ends / F= Flange design (PN 16) / M= Magnet

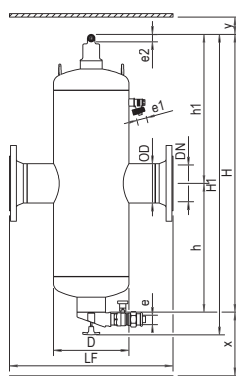

SPIROCOMBI MAGNET
FLANGE DESIGN

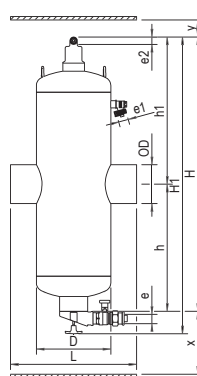

SPIROCOMBI MAGNET
WELD ENDS

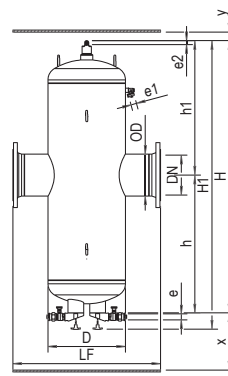

SPIROCOMBI MAGNET
FLANGE DESIGN
FROM DN 200

STANDARD SPIROCOMBI® – Steel solution without magnet – standard flow

Art.-No.	DN	OD	H	h1	h	D	L/LF	e1	ext.	e	int.	e2	ext.	x	y	Nom. flow rate	Nom. flow rate	Δp at nom. flow	Volume	Weight
		[mm]	[mm]	[mm]	[mm]	[mm]	[mm]							[mm]	[mm]	[m³/h]	[l/s]	[kPa]	[ltr]	[kg]
BC050L	50	60.3	630	365	265	159	260	G¾	(M)	Rp1	(F)	R½	(M)	>200	>50	12.50	3.47	3.0	7.0	12.0
BC050F	50	60.3	630	365	265	159	350	G¾	(M)	Rp1	(F)	R½	(M)	>200	>50	12.50	3.47	3.0	7.0	17.0
BC065L	65	76.1	630	365	265	159	260	G¾	(M)	Rp1	(F)	R½	(M)	>200	>50	20.00	5.56	2.7	7.0	12.0
BC065F	65	76.1	630	365	265	159	350	G¾	(M)	Rp1	(F)	R½	(M)	>200	>50	20.00	5.56	2.7	7.0	18.0
BC080L	80	88.9	785	440	345	219	370	G¾	(M)	Rp1	(F)	R½	(M)	>200	>50	27.00	7.50	2.9	25.0	24.0
BC080F	80	88.9	785	440	345	219	470	G¾	(M)	Rp1	(F)	R½	(M)	>200	>50	27.00	7.50	2.9	25.0	31.0
BC100L	100	114.3	785	440	345	219	370	G¾	(M)	Rp1	(F)	R½	(M)	>200	>50	47.00	13.06	3.7	25.0	24.0
BC100F	100	114.3	785	440	345	219	475	G¾	(M)	Rp1	(F)	R½	(M)	>200	>50	47.00	13.06	3.7	25.0	33.0
BC125L	125	139.7	1,035	560	475	324	525	G¾	(M)	Rp1	(F)	R½	(M)	>200	>50	72.00	20.00	4.2	75.0	58.0
BC125F	125	139.7	1,035	560	475	324	635	G¾	(M)	Rp1	(F)	R½	(M)	>200	>50	72.00	20.00	4.2	75.0	70.0
BC150L	150	168.3	1,035	560	475	324	525	G¾	(M)	Rp1	(F)	R½	(M)	>200	>50	108.00	30.00	4.9	75.0	58.0
BC150F	150	168.3	1,035	560	475	324	635	G¾	(M)	Rp1	(F)	R½	(M)	>200	>50	108.00	30.00	4.9	75.0	73.0
BC200F	200	219.1	1,315	700	615	406	775	G¾	(M)	Rp1	(F)	R½	(M)	>200	>50	180.00	50.00	5.8	150.0	135.0
BC250F	250	273.0	1,730	900	830	508	890	G¾	(M)	Rp2	(F)	R½	(M)	>200	>50	288.00	80.00	6.9	300.0	252.0
BC300F	300	323.9	2,025	1,055	970	610	1,005	G¾	(M)	Rp2	(F)	R½	(M)	>200	>50	405.00	112.50	7.7	500.0	325.0



Op. pressure
max. 10 bar



Temperature
max. 110 °C



Nom. flow velocity
1.5 m/s



without magnet

Products in the range are available up to DN800 and are made to order – prices on application.

L= Weld ends / F= Flange design (PN 16)

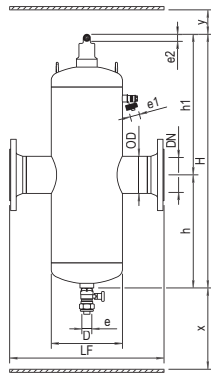

SPIROCOMBI
FLANGE DESIGN

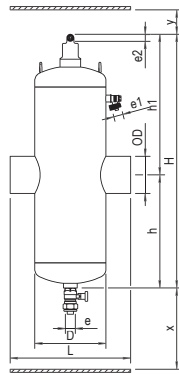

SPIROCOMBI
WELD ENDS

SPIROCOMBI® – Demountable steel solution without magnet – standard flow

SPECIAL

Art.-No.	DN	OD	H	h1	h	D	L/LF	DF	e1	ext.	e	int.	e2	ext.	x	y	Nom. flow rate	Nom. flow rate	Δp at nom. flow	Volume	Weight
		[mm]	[mm]	[mm]	[mm]	[mm]	[mm]	[mm]							[mm]	[mm]	[m³/h]	[l/s]	[kPa]	[ltr]	[kg]
BD050L	50	60.3	630	365	265	159	260	285	G¾	(M)	Rp1	(F)	R½	(M)	>510	>50	12.50	3.47	3.0	7.0	30.0
BD050F	50	60.3	630	365	265	159	350	285	G¾	(M)	Rp1	(F)	R½	(M)	>510	>50	12.50	3.47	3.0	7.0	35.0
BD065L	65	76.1	630	365	265	159	260	285	G¾	(M)	Rp1	(F)	R½	(M)	>510	>50	20.00	5.56	2.7	7.0	30.0
BD065F	65	76.1	630	365	265	159	350	285	G¾	(M)	Rp1	(F)	R½	(M)	>510	>50	20.00	5.56	2.7	7.0	36.0
BD080L	80	88.9	785	440	345	219	370	340	G¾	(M)	Rp1	(F)	R½	(M)	>660	>50	27.00	7.50	2.9	25.0	50.0
BD080F	80	88.9	785	440	345	219	470	340	G¾	(M)	Rp1	(F)	R½	(M)	>660	>50	27.00	7.50	2.9	25.0	58.0
BD100L	100	114.3	785	440	345	219	370	340	G¾	(M)	Rp1	(F)	R½	(M)	>660	>50	47.00	13.06	3.7	25.0	50.0
BD100F	100	114.3	785	440	345	219	475	340	G¾	(M)	Rp1	(F)	R½	(M)	>660	>50	47.00	13.06	3.7	25.0	60.0
BD125L	125	139.7	1,035	560	475	324	525	460	G¾	(M)	Rp1	(F)	R½	(M)	>920	>50	72.00	20.00	4.2	75.0	110.0
BD125F	125	139.7	1,035	560	475	324	635	460	G¾	(M)	Rp1	(F)	R½	(M)	>920	>50	72.00	20.00	4.2	75.0	123.0
BD150L	150	168.3	1,035	560	475	324	525	460	G¾	(M)	Rp1	(F)	R½	(M)	>920	>50	108.00	30.00	4.9	75.0	110.0
BD150F	150	168.3	1,035	560	475	324	635	460	G¾	(M)	Rp1	(F)	R½	(M)	>920	>50	108.00	30.00	4.9	75.0	126.0
BD200F	200	219.1	1,315	700	615	406	775	580	G¾	(M)	Rp1	(F)	R½	(M)	>1.200	>50	180.00	50.00	5.8	150.0	225.0
BD250F	250	273.0	1,730	900	830	508	890	715	G¾	(M)	Rp2	(F)	R½	(M)	>1.600	>50	288.00	80.00	6.9	300.0	364.0
BD300F	300	323.9	2,025	1,055	970	610	1,005	840	G¾	(M)	Rp2	(F)	R½	(M)	>1.900	>50	405.00	112.50	7.7	500.0	563.0

 Op. pressure
max. 10 bar

 Temperature
max. 110 °C

 Nom. flow velocity
1.5 m/s

 without magnet

L = Weld ends / F = Flange design (PN 16)

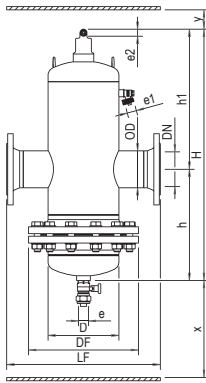

SPIROCOMBI
DEMOUNTABLE
HI-FLOW
FLANGE DESIGN

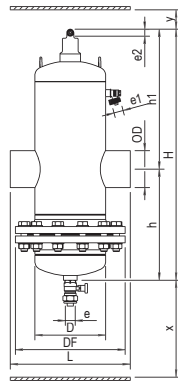

SPIROCOMBI
DEMOUNTABLE
HI-FLOW
WELD ENDS

CUSTOM

Please visit page 30 for further information on our custom products.

SPIROCOMBI® – Steel solution without magnet – Hi-flow

SPECIAL

Art.-No.	DN	OD	H	h1	h	D	L/LF	e1	ext.	e	int.	e2	ext.	x	y	Nom. flow rate	Nom. flow rate	Δp at nom. flow	Volume	Weight
	[mm]	[mm]	[mm]	[mm]	[mm]	[mm]	[mm]							[mm]	[mm]	[m³/h]	[l/s]	[kPa]	[ltr]	[kg]
HC050L	50	60.3	910	505	405	159	260	G¾	(M)	Rp1	(F)	R½	(M)	>200	>50	25.00	6.94	11.7	10.0	18.0
HC050F	50	60.3	910	505	405	159	350	G¾	(M)	Rp1	(F)	R½	(M)	>200	>50	25.00	6.94	11.7	10.0	23.0
HC065L	65	76.1	910	505	405	159	260	G¾	(M)	Rp1	(F)	R½	(M)	>200	>50	40.00	11.11	11.9	10.0	18.0
HC065F	65	76.1	910	505	405	159	350	G¾	(M)	Rp1	(F)	R½	(M)	>200	>50	40.00	11.11	11.9	10.0	24.0
HC080L	80	88.9	1,145	620	525	219	370	G¾	(M)	Rp1	(F)	R½	(M)	>200	>50	54.00	15.00	12.4	37.0	36.0
HC080F	80	88.9	1,145	620	525	219	470	G¾	(M)	Rp1	(F)	R½	(M)	>200	>50	54.00	15.00	12.4	37.0	43.0
HC100L	100	114.3	1,145	620	525	219	370	G¾	(M)	Rp1	(F)	R½	(M)	>200	>50	94.00	26.11	14.7	37.0	36.0
HC100F	100	114.3	1,145	620	525	219	475	G¾	(M)	Rp1	(F)	R½	(M)	>200	>50	94.00	26.11	14.7	37.0	45.0
HC125L	125	139.7	1,570	825	745	324	525	G¾	(M)	Rp1	(F)	R½	(M)	>200	>50	144.00	40.00	16.9	115.0	90.0
HC125F	125	139.7	1,570	825	745	324	635	G¾	(M)	Rp1	(F)	R½	(M)	>200	>50	144.00	40.00	16.9	115.0	102.0
HC150L	150	168.3	1,570	825	745	324	525	G¾	(M)	Rp1	(F)	R½	(M)	>200	>50	215.00	59.72	19.2	115.0	90.0
HC150F	150	168.3	1,570	825	745	324	635	G¾	(M)	Rp1	(F)	R½	(M)	>200	>50	215.00	59.72	19.2	115.0	105.0
HC200F	200	219.1	1,995	1,040	955	406	775	G¾	(M)	Rp1	(F)	R½	(M)	>200	>50	360.00	100.00	23.4	230.0	195.0
HC250F	250	273.0	2,680	1,385	1,295	508	890	G¾	(M)	Rp2	(F)	R½	(M)	>200	>50	575.00	159.72	27.5	500.0	343.0
HC300F	300	323.9	3,190	1,640	1,550	610	1,005	G¾	(M)	Rp2	(F)	R½	(M)	>200	>50	810.00	225.00	31.2	830.0	484.0



Op. pressure
max. 10 bar



Temperature
max. 110 °C



Nom. flow velocity
3 m/s



without magnet

Products in the range are available up to DN800 and are made to order – prices on application.

L = Weld ends / F = Flange design (PN 16)

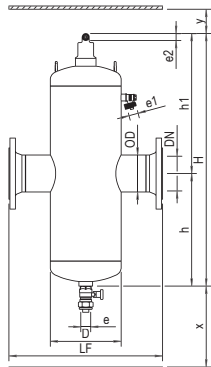

SPIROCOMBI HI-FLOW
FLANGE DESIGN

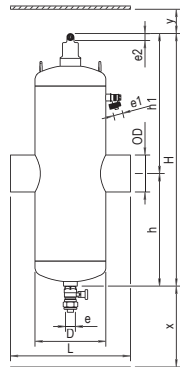

SPIROCOMBI HI-FLOW
WELD ENDS

CUSTOM

Please visit page 30 for further information on our custom products.

SPIROCOMBI® – Demountable steel solution without magnet – Hi-flow

SPECIAL

Art.-No.	DN	OD	H	h1	h	D	L/LF	DF	e1	ext.	e	int.	e2	ext.	x	y	Nom. flow rate	Nom. flow rate	Δp at nom. flow	Volume	Weight
		[mm]	[mm]	[mm]	[mm]	[mm]	[mm]	[mm]							[mm]	[mm]	[m³/h]	[l/s]	[kPa]	[ltr]	[kg]
HD050L	50	60.3	910	505	405	159	260	285	G¾	(M)	Rp1	(F)	R½	(M)	>790	>50	25.00	6.94	11.7	10.0	38
HD050F	50	60.3	910	505	405	159	350	285	G¾	(M)	Rp1	(F)	R½	(M)	>790	>50	25.00	6.94	11.7	10.0	43
HD065L	65	76.1	910	505	405	159	260	285	G¾	(M)	Rp1	(F)	R½	(M)	>790	>50	40.00	11.11	11.9	10.0	38
HD065F	65	76.1	910	505	405	159	350	285	G¾	(M)	Rp1	(F)	R½	(M)	>790	>50	40.00	11.11	11.9	10.0	44
HD080L	80	88.9	1,145	620	525	219	370	340	G¾	(M)	Rp1	(F)	R½	(M)	>1.020	>50	54.00	15.00	12.4	37.0	60
HD080F	80	88.9	1,145	620	525	219	470	340	G¾	(M)	Rp1	(F)	R½	(M)	>1.020	>50	54.00	15.00	12.4	37.0	68
HD100L	100	114.3	1,145	620	525	219	370	340	G¾	(M)	Rp1	(F)	R½	(M)	>1.020	>50	94.00	26.11	14.7	37.0	60
HD100F	100	114.3	1,145	620	525	219	475	340	G¾	(M)	Rp1	(F)	R½	(M)	>1.020	>50	94.00	26.11	14.7	37.0	70
HD125L	125	139.7	1,570	825	745	324	525	460	G¾	(M)	Rp1	(F)	R½	(M)	>1.450	>50	144.00	40.00	16.9	115.0	140
HD125F	125	139.7	1,570	825	745	324	635	460	G¾	(M)	Rp1	(F)	R½	(M)	>1.450	>50	144.00	40.00	16.9	115.0	153
HD150L	150	168.3	1,570	825	745	324	525	460	G¾	(M)	Rp1	(F)	R½	(M)	>1.450	>50	215.00	59.72	19.2	115.0	140
HD150F	150	168.3	1,570	825	745	324	635	460	G¾	(M)	Rp1	(F)	R½	(M)	>1.450	>50	215.00	59.72	19.2	115.0	156
HD200F	200	219.1	1,995	1,040	955	406	775	580	G¾	(M)	Rp1	(F)	R½	(M)	>1.880	>50	360.00	100.00	23.4	230.0	295
HD250F	250	273.0	2,680	1,385	1,295	508	890	715	G¾	(M)	Rp2	(F)	R½	(M)	>2.560	>50	575.00	159.72	27.5	500.0	573
HD300F	300	323.9	3,190	1,640	1,550	610	1,005	840	G¾	(M)	Rp2	(F)	R½	(M)	>3.070	>50	810.00	225.00	31.2	830.0	1,018

Op. pressure
max. 10 bar

Temperature
max. 110 °C

Nom. flow velocity
3 m/s

without magnet

L= Weld ends / F= Flange design (PN 16)

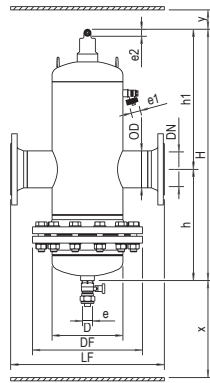

SPIROCOMBI
DEMOUNTABLE
HI-FLOW
FLANGE DESIGN

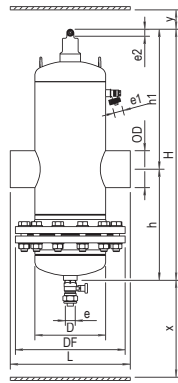

SPIROCOMBI
DEMOUNTABLE
HI-FLOW
WELD ENDS

CUSTOM

Please visit page 30 for further information on our custom products.

HYDRAULIC DEAERATORS AND DIRT SEPARATORS

SPIROCROSS®



Industry-leading
20-year guarantee

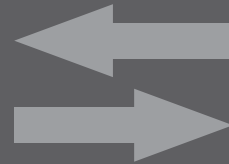

Minimal fluid
mixing



3-in-1 operation:
balancing, deaeration,
dirt separation



Increased energy
efficiency



3-in-1 savings:
space, time, costs

All images used are for illustrative purposes only. Individual features like material used (i.e. brass or steel) may vary, as may guarantee.

SPIROCROSS®

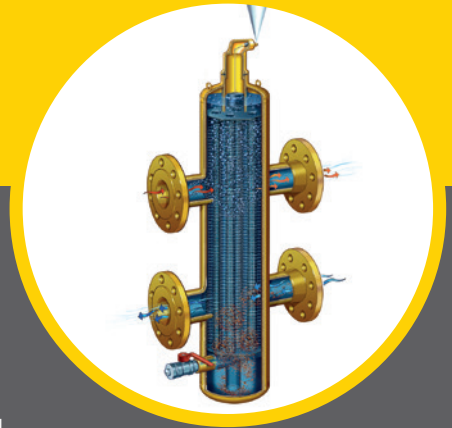

BENEFITS OF SPIROCROSS

- Three functions in a single component
- Just four connections instead of eight
- Optimal hydraulic balance between primary and secondary pumps
- Spirotube guarantees minimal fluid mixing and thus the best temperature differential
- Real, active deaeration and dirt separation
- Even the tiniest air bubbles and dirt particles are separated and removed
- Constant low pressure drop
- Compact design and limited build height, thanks to the Spirotube
- Exceptional guarantee

SPIROCROSS HYDRAULIC DEAERATORS AND DIRT SEPARATORS

A good hydraulic balance is highly important for HVAC and process systems with separated circuits or several groups and pumps. The effective removal of air and dirt also contributes towards the achievement of optimum system performance. Hydraulic balancing and air and dirt separation are combined in the SpiroCross.

Thanks to the combination of 3 functions in 1, savings will not only be made in purchasing but also in space, installation and maintenance costs.



DEAERATION AND DIRT SEPARATION IN PERFECT BALANCE

The unique Spirotube ensures active deaeration and dirt separation in a very compact design and guarantees a perfect balance with minimal fluid mixing. Although the Spirotube can trap the smallest microbubbles and dirt particles, it has a very open structure which means that the SpiroCross does not clog up. Flow and pressure drop are not affected by the accumulated dirt, since it is collected outside the main flow.

HOW DOES A HYDRAULIC SEPARATOR WORK?

A hydraulic separator balances the differences in volumetric flow between a primary circuit (supply = Q_p) and a secondary circuit (demand = Q_s). Three operating situations can occur if a hydraulic separator is installed in a system and these are shown below and to the right.

Situation 1: $Q_p = Q_s$ $\Delta T_p = \Delta T_s$ $T_2 = T_4$

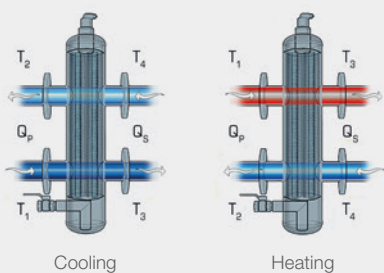

Situation 2: $Q_p < Q_s$ $\Delta T_p > \Delta T_s$ $T_2 = T_4$

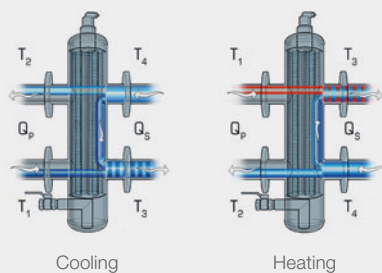

Situation 3: $Q_p > Q_s$ $\Delta T_p < \Delta T_s$ $T_1 = T_3$

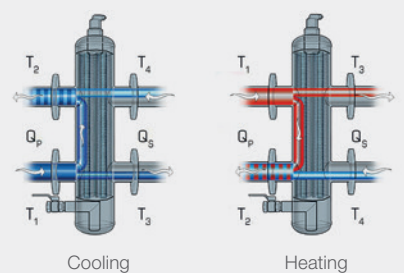

SPIROCROSS®

Brass solution

SPIROCROSS® – Brass solution

STANDARD

Art.-No.	Connec- tion d	int.	H	h	h1	h2	D	L	b	e	ext.	e2	ext.	x	y	Nom. flow rate	Nom. flow rate	Volume	Weight
			[mm]	[mm]	[mm]	[mm]	[mm]	[mm]	[mm]					[mm]	[mm]	[m³/h]	[l/s]	[ltr]	[kg]
AX100	G1	(F)	462	135	144	183	80	236	52	G¾	(M)	R½	(M)	>200	>50	2.00	0.56	1.5	6.5
AX125	G1¼	(F)	462	135	144	183	80	236	52	G¾	(M)	R½	(M)	>200	>50	3.60	1.00	1.5	6.5
AX150	G1½	(F)	462	135	144	183	80	236	52	G¾	(M)	R½	(M)	>200	>50	5.00	1.39	1.5	6.5



Op. pressure
max. 10 bar



Temperature
max. 110 °C



Nom. flow velocity
1.5 m/s

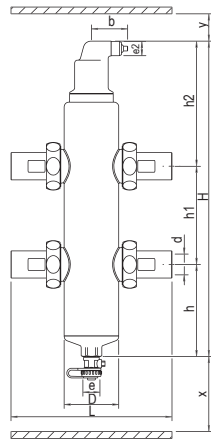

SPIROCROSS
BRASS

SPIROCROSS® – Accessories for brass solution

ACCESSORIES

Art.-No.	Description	Suitable for
TAX150	Insulation Set SpiroCross Brass	AX100/125/150

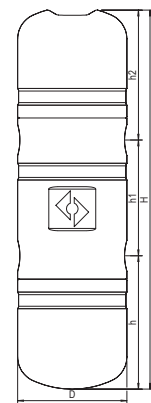

SPIROCROSS
INSULATION SET

SPIROCROSS®

SPIROCROSS® – Steel solution

STANDARD

Art.-No.	DN	OD	H	h	h1	h2	h3	D	L/LF	e	int.	e2	ext.	x	y	Nom. flow rate	Nom. flow rate	Volume	Weight
		[mm]	[mm]	[mm]	[mm]	[mm]	[mm]	[mm]	[mm]					[mm]	[mm]	[m³/h]	[l/s]	[ltr]	[kg]
XC050L	50	60.3	815	238	240	337	100	159	260	Rp1	(F)	R½	(M)	>75	>50	12.50	3.47	12.0	13.0
XC050F	50	60.3	815	238	240	337	100	159	350	Rp1	(F)	R½	(M)	>75	>50	12.50	3.47	12.0	26.0
XC065L	65	76.1	905	251	305	349	100	159	260	Rp1	(F)	R½	(M)	>75	>50	20.00	5.56	13.0	19.0
XC065F	65	76.1	905	251	305	349	100	159	350	Rp1	(F)	R½	(M)	>75	>50	20.00	5.56	13.0	31.0
XC080L	80	88.9	999	270	360	369	110	219	370	Rp1	(F)	R½	(M)	>100	>50	27.00	7.50	29.0	33.0
XC080F	80	88.9	999	270	360	369	110	219	470	Rp1	(F)	R½	(M)	>100	>50	27.00	7.50	29.0	49.0
XC100L	100	114.3	1,261	351	460	450	110	219	370	Rp1	(F)	R½	(M)	>100	>50	47.00	13.06	38.0	43.0
XC100F	100	114.3	1,261	351	460	450	110	219	475	Rp1	(F)	R½	(M)	>100	>50	47.00	13.06	38.0	60.0
XC125L	125	139.7	1,546	443	560	543	130	324	525	Rp1	(F)	R½	(M)	>100	>50	72.00	20.00	105.0	95.0
XC125F	125	139.7	1,546	443	560	543	130	324	635	Rp1	(F)	R½	(M)	>100	>50	72.00	20.00	105.0	119.0
XC150L	150	168.3	1,781	505	670	606	130	324	525	Rp1	(F)	R½	(M)	>100	>50	108.00	30.00	123.0	110.0
XC150F	150	168.3	1,781	505	670	606	130	324	635	Rp1	(F)	R½	(M)	>100	>50	108.00	30.00	123.0	140.0
XC200F	200	219.1	2,321	675	870	776	170	406	775	Rp1	(F)	R½	(M)	>100	>50	180.00	50.00	252.0	274.0
XC250F	250	273.0	2,870	835	1,100	935	215	508	890	Rp2	(F)	R½	(M)	>100	>50	288.00	80.00	501.0	413.0
XC300F	300	323.9	3,388	996	1,295	1,097	245	610	1,005	Rp2	(F)	R½	(M)	>100	>50	405.00	112.50	859.0	656.0

 Op. pressure
max. 10 bar

 Temperature
max. 110 °C

 Nom. flow velocity
1.5 m/s

Products in the range are available up to DN800 and are made to order – prices on application.

L= Weld ends / F= Flange design (PN 16)

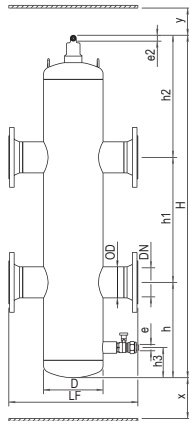

SPIROCROSS
FLANGE DESIGN

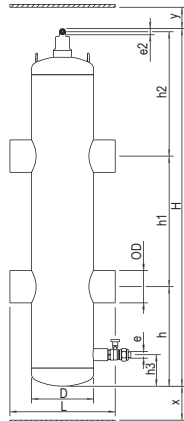

SPIROCROSS
WELD ENDS

SPIROCROSS®

Steel solution

SPIROCROSS® R

STANDARD

Art.-No.	DN	OD	H	h1	h2	h3	h4	D	L	Nom. flow rate	Volume	Weight	Matching insulation
		[mm]	[mm]	[mm]	[mm]	[mm]	[mm]	[mm]	[mm]	[m ³ /h]	[litr]	[kg]	
XC065FK45A01	65	76.1	905	104.5	215	250.5	305	159	462	15.0	15.0	31.0	TBX065
XC100FK45A01	100	114.3	1,261	97.0	215	351	460	219	744	40.0	45.0	67.0	TBX100



Op. pressure PS*
max. 6 bar



Temperature TS*
max. 110 °C



Nom. flow velocity
1.5 m/s

Flanges: PN6

* See graph

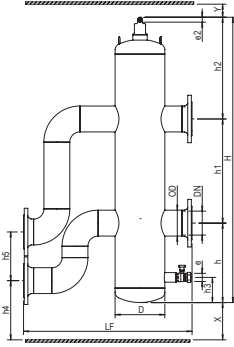

SPIROCROSS R

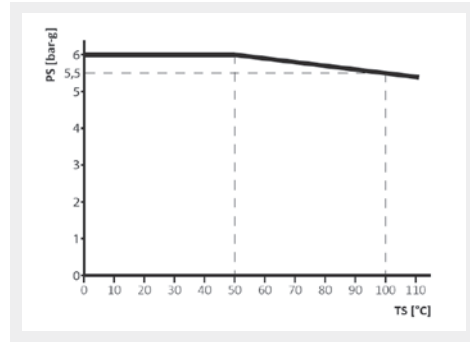

SpiroCross R, pressure and temperature range

CUSTOM

Please visit page 30 for further information on our custom products.

SPIROCROSS® – Accessories for steel solution

ACCESSORIES

Art.-No.	Description	Suitable for
TBX050	Insulation Set SpiroCross Steel	XC050F/L
TBX065	Insulation Set SpiroCross Steel	XC065F/L
TBX080	Insulation Set SpiroCross Steel	XC080F/L
TBX100	Insulation Set SpiroCross Steel	XC100F/L
TBX125	Insulation Set SpiroCross Steel	XC125F/L
TBX150	Insulation Set SpiroCross Steel	XC150F/L

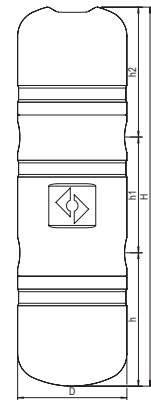

SPIROCROSS INSULATION SET

SPIROCROSS®

VACUUM DEGASSING AND PRESSURISATION

SPIROPRESS®



Correct pressure throughout the system



Reduced operating costs



Air levels reduced to absolute minimum



Maximised efficiency of all system components



Reduction of malfunction and downtime

All images used are for illustrative purposes only. Individual features like material used (i.e. brass or steel) may vary, as may guarantee.

SPIROPRESS®



BENEFITS OF SPIROPRESS

The Spirotech approach, combining deaeration and dirt separation along with pressurisation will render the following benefits:

- A correctly designed system
- Increase System Efficiency
- Dramatically reduce maintenance costs for Pump Seals, Fouling of Control Valves, Blockages in Heat Exchangers

SPIROPRESS VACUUM DEGASSING AND PRESSURISATION

SpiroPress enables automatic pressure monitoring and control and provides degassed makeup water. Adding a pressurisation solution to our established degassing products makes it possible to provide a total, integrated system care solution.

Today's highly energy-efficient heating and cooling systems offer optimal performance with air-free water. Most issues within HVAC systems are closely related to air being introduced into the system as a result of pressurisation issues. A poorly designed, installed or maintained pressurisation system can lead to negative pressures around the circuit. The introduction of oxygen through leaks or by refilling with undegassed, mostly hard water also makes corrosion inhibitors significantly less effective.

HYDRONIC STABILITY

The use of fluid as the heat-transfer medium in heating and cooling systems is a dynamic process. Hydronic stability means the fluid can transfer heat or cold at any location in the system, at any given time. Pressurisation is a key factor in hydronic stability.

WIDE RANGE OF SOLUTIONS

SpiroPress covers a wide range of installations, from the most basic setup to the most extended, complicated system. All units are used to provide both full vacuum degassing of the system water. Makeup water is degassed prior to system entry, offering substantial long-term protection. Not just for the commissioning phase, but for the entire lifetime of the system. SpiroPress can dramatically increase performance and avoid premature failure of major system components and, together with dirt separation and degassing, provide a system that performs the way it has been designed to delete.



SPIROPRESS MULTICONTROL

- For use in systems generally with large volumes and high pressures and also if space is limited and traditional fixed gas cushion type vessels are difficult to accommodate.
- The SpiroPress MultiControl range offers a multitude of units to cover all system volumes and pressures.
- Special units are also available upon request for systems operating at higher pressures.

SPIROPRESS CONTROL

- For use in systems generally up to (but not limited to) 300 m³. The SpiroPress Control range offers a choice of 4 units to cover the pressure range from 1 bar to 16 bar.
- All units are used to provide both full vacuum degassing of the system water and make-up water is also degassed prior to entering the system offering substantial long-term protection of the system.

SPIROPRESS FILL

- Primarily for use in smaller systems with relatively low pressures and volumes.
- The SpiroPress Fill range offers the choice of a simple mechanical auto-fill unit or a wall-hung pumped fill unit.

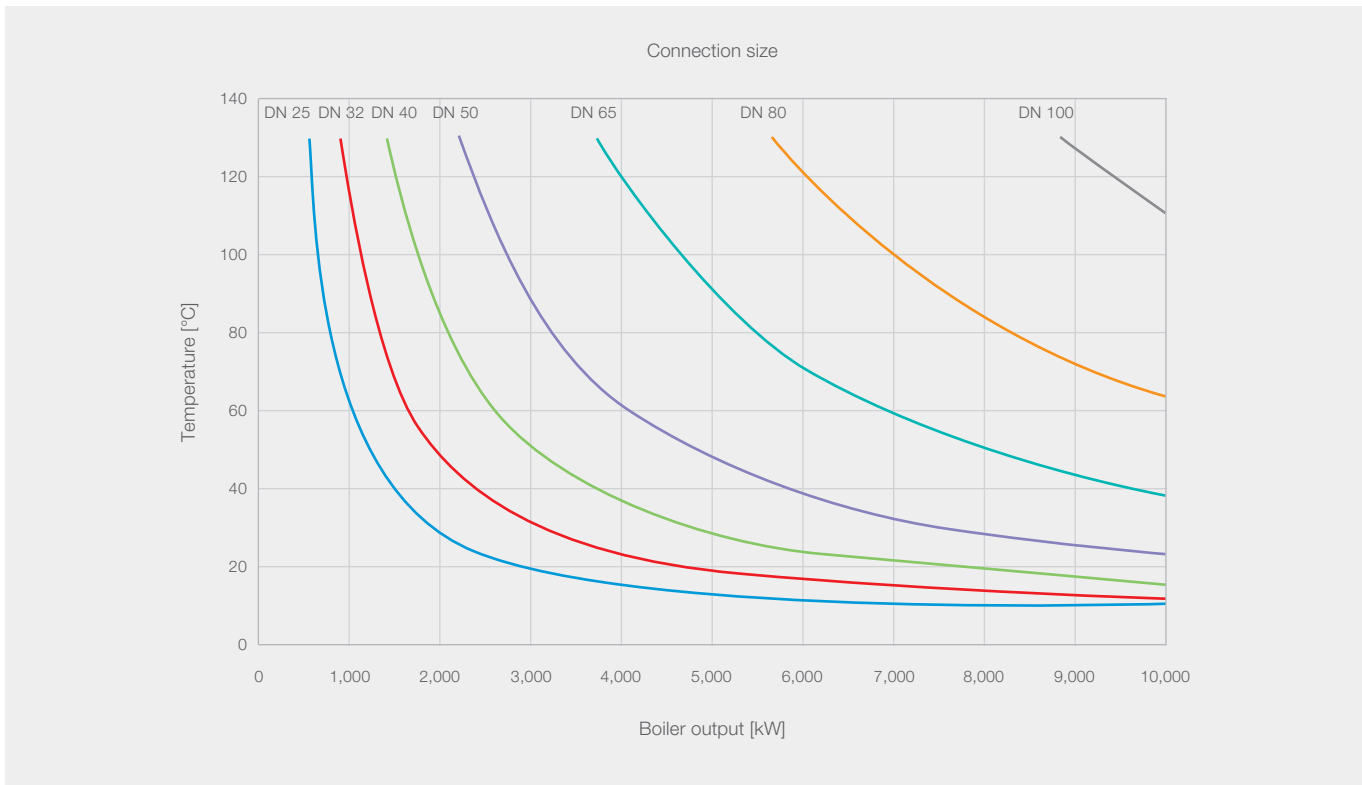

SPIROPRESS® – SpiroPress PicoControl Kompact, Single pump 1 x 100 %, Single valve 1 x 100 %

Art.-No.	Volume	Upper working pressure range
EPCK-S45-4.0	volume 45 litre	1.0–4.0 bar
EPCK-S75-4.0	volume 75 litre	1.0–4.0 bar
EPCK-S125-4.0	volume 125 litre	1.0–4.0 bar
EPCK-S200-4.0	volume 200 litre	1.0–4.0 bar
EPCK-S300-4.0	volume 300 litre	1.0–4.0 bar
EPCK-S500-4.0	volume 500 litre	1.0–4.0 bar

SPIROPRESS® – MultiControl Kompact – SOLO, Single pump 1 x 100 %, Single valve 1 x 100 %

Art.-No.	Volume	Upper working pressure range
EMCK-S45-4.0	volume 45 litre	1.0–4.0 bar
EMCK-S75-4.0	volume 75 litre	1.0–4.0 bar
EMCK-S125-4.0	volume 125 litre	1.0–4.0 bar
EMCK-S200-4.0	volume 200 litre	1.0–4.0 bar
EMCK-S300-4.0	volume 300 litre	1.0–4.0 bar
EMCK-S500-4.0	volume 500 litre	1.0–4.0 bar
EMCK-S45-5.6	volume 45 litre	2.0–5.6 bar
EMCK-S75-5.6	volume 75 litre	2.0–5.6 bar
EMCK-S125-5.6	volume 125 litre	2.0–5.6 bar
EMCK-S200-5.6	volume 200 litre	2.0–5.6 bar
EMCK-S300-5.6	volume 300 litre	2.0–5.6 bar
EMCK-S500-5.6	volume 500 litre	2.0–5.6 bar
EMCK-S45-8.1	volume 45 litre	4.0–8.1 bar
EMCK-S75-8.1	volume 75 litre	4.0–8.1 bar
EMCK-S125-8.1	volume 125 litre	4.0–8.1 bar
EMCK-S200-8.1	volume 200 litre	4.0–8.1 bar
EMCK-S300-8.1	volume 300 litre	4.0–8.1 bar
EMCK-S500-8.1	volume 500 litre	4.0–8.1 bar

SPIROPRESS® – MultiControl Kompact – DUO, Double pump 2 x 50 %, Single valve 1 x 100 %

EMCK-D45-4.0	volume 45 litre	1.0–4.0 bar
EMCK-D75-4.0	volume 75 litre	1.0–4.0 bar
EMCK-D125-4.0	volume 125 litre	1.0–4.0 bar
EMCK-D200-4.0	volume 200 litre	1.0–4.0 bar
EMCK-D300-4.0	volume 300 litre	1.0–4.0 bar
EMCK-D500-4.0	volume 500 litre	1.0–4.0 bar
EMCK-D45-5.6	volume 45 litre	2.4–5.6 bar
EMCK-D75-5.6	volume 75 litre	2.4–5.6 bar
EMCK-D125-5.6	volume 125 litre	2.4–5.6 bar
EMCK-D200-5.6	volume 200 litre	2.4–5.6 bar
EMCK-D300-5.6	volume 300 litre	2.4–5.6 bar
EMCK-D500-5.6	volume 500 litre	2.4–5.6 bar
EMCK-D200-6.6	volume 200 litre	2.4–6.6 bar
EMCK-D45-6.6	volume 45 litre	2.4–6.6 bar
EMCK-D45-8.1	volume 45 litre	6.0–8.1 bar
EMCK-D75-8.1	volume 75 litre	6.0–8.1 bar
EMCK-D125-8.1	volume 125 litre	6.0–8.1 bar
EMCK-D200-8.1	volume 200 litre	6.0–8.1 bar
EMCK-D300-8.1	volume 300 litre	6.0–8.1 bar
EMCK-D500-8.1	volume 500 litre	6.0–8.1 bar

SPIROPRESS® – MultiControl Kompact – DUO/TWIN, Double pump 2 x 50 %, Double valve 2 x 100 %

Art.-No.	Volume	Upper working pressure range
EMCK-D45-4.0-twin	volume 45 litre	1.0–4.0 bar
EMCK-D75-4.0-twin	volume 75 litre	1.0–4.0 bar
EMCK-D125-4.0-twin	volume 125 litre	1.0–4.0 bar
EMCK-D200-4.0-twin	volume 200 litre	1.0–4.0 bar
EMCK-D300-4.0-twin	volume 300 litre	1.0–4.0 bar
EMCK-D500-4.0-twin	volume 500 litre	1.0–4.0 bar
EMCK-D45-5.6-twin	volume 45 litre	2.4–5.6 bar
EMCK-D75-5.6-twin	volume 75 litre	2.4–5.6 bar
EMCK-D125-5.6-twin	volume 125 litre	2.4–5.6 bar
EMCK-D200-5.6-twin	volume 200 litre	2.4–5.6 bar
EMCK-D300-5.6-twin	volume 300 litre	2.4–5.6 bar
EMCK-D500-5.6-twin	volume 500 litre	2.4–5.6 bar
EMCK-D45-6.6-twin	volume 45 litre	2.4–6.6 bar
EMCK-D75-6.6-twin	volume 75 litre	2.4–6.6 bar
EMCK-D125-6.6-twin	volume 125 litre	2.4–6.6 bar
EMCK-D200-6.6-twin	volume 200 litre	2.4–6.6 bar
EMCK-D300-6.6-twin	volume 300 litre	2.4–6.6 bar
EMCK-D500-6.6-twin	volume 500 litre	2.4–6.6 bar
EMCK-D45-8.1-twin	volume 45 litre	4.0–8.1 bar
EMCK-D75-8.1-twin	volume 75 litre	4.0–8.1 bar
EMCK-D125-8.1-twin	volume 125 litre	4.0–8.1 bar
EMCK-D200-8.1-twin	volume 200 litre	4.0–8.1 bar
EMCK-D300-8.1-twin	volume 300 litre	4.0–8.1 bar
EMCK-D500-8.1-twin	volume 500 litre	4.0–8.1 bar

SPIROPRESS® – MultiControl Kompact – MAXI, Double pump 2 x 100 %, Single valve 1 x 100 %

EMCK-M45-4.0	volume 45 litre	1.0–4.0 bar
EMCK-M75-4.0	volume 75 litre	1.0–4.0 bar
EMCK-M125-4.0	volume 125 litre	1.0–4.0 bar
EMCK-M200-4.0	volume 200 litre	1.0–4.0 bar
EMCK-M300-4.0	volume 300 litre	1.0–4.0 bar
EMCK-M500-4.0	volume 500 litre	1.0–4.0 bar
EMCK-M45-5.6	volume 45 litre	2.0–5.6 bar
EMCK-M75-5.6	volume 75 litre	2.0–5.6 bar
EMCK-M125-5.6	volume 125 litre	2.0–5.6 bar
EMCK-M200-5.6	volume 200 litre	2.0–5.6 bar
EMCK-M300-5.6	volume 300 litre	2.0–5.6 bar
EMCK-M500-5.6	volume 500 litre	2.0–5.6 bar
EMCK-M45-8.1	volume 45 litre	4.0–8.1 bar
EMCK-M75-8.1	volume 75 litre	4.0–8.1 bar
EMCK-M125-8.1	volume 125 litre	4.0–8.1 bar
EMCK-M200-8.1	volume 200 litre	4.0–8.1 bar
EMCK-M300-8.1	volume 300 litre	4.0–8.1 bar
EMCK-M500-8.1	volume 500 litre	4.0–8.1 bar

SPIROPRESS® – MultiControl Kompact – MAXI/TWIN, Double pump 2 x 100 %, Double valve 2 x 100 %

Art.-No.	Volume	Upper working pressure range
EMCK-M45-4.0-twin	volume 45 litre	1.0–4.0 bar
EMCK-M75-4.0-twin	volume 75 litre	1.0–4.0 bar
EMCK-M125-4.0-twin	volume 125 litre	1.0–4.0 bar
EMCK-M200-4.0-twin	volume 200 litre	1.0–4.0 bar
EMCK-M300-4.0-twin	volume 300 litre	1.0–4.0 bar
EMCK-M500-4.0-twin	volume 500 litre	1.0–4.0 bar
EMCK-M45-5.6-twin	volume 45 litre	2.0–5.6 bar
EMCK-M75-5.6-twin	volume 75 litre	2.0–5.6 bar
EMCK-M125-5.6-twin	volume 125 litre	2.0–5.6 bar
EMCK-M200-5.6-twin	volume 200 litre	2.0–5.6 bar
EMCK-M300-5.6-twin	volume 300 litre	2.0–5.6 bar
EMCK-M500-5.6-twin	volume 500 litre	2.0–5.6 bar
EMCK-M45-8.1-twin	volume 45 litre	4.0–8.1 bar
EMCK-M75-8.1-twin	volume 75 litre	4.0–8.1 bar
EMCK-M125-8.1-twin	volume 125 litre	4.0–8.1 bar
EMCK-M200-8.1-twin	volume 200 litre	4.0–8.1 bar
EMCK-M300-8.1-twin	volume 300 litre	4.0–8.1 bar
EMCK-M500-8.1-twin	volume 500 litre	4.0–8.1 bar

SPIROPRESS® – MultiControl Kompact – Partner package

Art.-No.	Content	Volume	Upper working pressure range
E52600	EMCK-S200-5.6_MCF-1_ST_GH	Volume 200 liter	5,6 bar
E52601	EMCK-S300-5.6_MCF-1_ST_GH	Volume 300 liter	5,6 bar
E52602	EMCK-S500-5.6_MCF-1_ST_GH	Volume 500 liter	5,6 bar
E52603	EMCK-S500-5.6_Z500_MCF-1_ST_GH	Volume 500 liter	5,6 bar
E52604	EMCK-S500-5.6_ZZ500_MCF-1_ST_GH	Volume 500 liter	5,6 bar
E52605	EMCK-S75-5.6_MCF-1_ST_GH	Volume 75 liter	5,6 bar
E52606	EMCK-S125-5.6_MCF-1_ST_GH	Volume 125 liter	5,6 bar
E52607	EMCK-S45-5.6_MCF-1_ST_GH	Volume 45 liter	5,6 bar
E52610	EMCK-S75-5.6_MCF-1	Volume 75 liter	5,6 bar
E52611	EMCK-S125-5.6_MCF-1	Volume 125 liter	5,6 bar
E52612	EMCK-S200-5.6_MCF-1	Volume 200 liter	5,6 bar
E52613	EMCK-S300-5.6_MCF-1	Volume 300 liter	5,6 bar
E52614	EMCK-S500-5.6_MCF-1	Volume 500 liter	5,6 bar
E52615	EMCK-S500-5.6_Z500_MCF-1	Volume 500 liter	5,6 bar
E52616	EMCK-S500-5.6_ZZ500_MCF-1	Volume 500 liter	5,6 bar
E52617	EMCK-S45-5.6_MCF-1	Volume 45 liter	5,6 bar
E52620	EMCK-S75-4.0_MCF-1	Volume 75 liter	4,0 bar
E52621	EMCK-S125-4.0_MCF-1	Volume 125 liter	4,0 bar
E52622	EMCK-S200-4.0_MCF-1	Volume 200 liter	4,0 bar
E52623	EMCK-S300-4.0_MCF-1	Volume 300 liter	4,0 bar
E52624	EMCK-S500-4.0_MCF-1	Volume 500 liter	4,0 bar
E52625	EMCK-S500-4.0_Z500_MCF-1	Volume 500 liter	4,0 bar
E52626	EMCK-S500-4.0_ZZ500_MCF-1	Volume 500 liter	4,0 bar
E52627	EMCK-S45-4.0_MCF-1	Volume 45 liter	4,0 bar
E55370	MCA-S1-2.7_G640	Volume 640 liter	2,7 bar
E55371	MCA-S1-2.7_G1000	Volume 1.000 liter	2,7 bar
E55375	MCA-S1-5.2_G640	Volume 640 liter	5,2 bar
E55376	MCA-S1-5.2_G1000	Volume 1.000 liter	5,2 bar

SPIROPRESS® – MultiControl Modular – SOLO, Single pump 1 x 100 %, Single valve 1 x 100 %

Art.-No.	Upper working pressure range
EMCM-S1-4.0	1.0–4.0 bar
EMCM-S2-7.8	4.0–7.8 bar
EMCM-S3-10.0	4.0–10.0 bar
EMCM-S4-6.2	2.4–6.2 bar
EMCM-S5-6.2	2.4–6.2 bar
EMCM-S6-10.1	6.0–10.1 bar
EMCM-S8-16.0	8.0–16.0 bar
EMCM-S1-5.6	2.0–5.6 bar
EMCM-S2-6.0	2.0–6.0 bar
EMCM-S9-11.0	6.0–11.0 bar
EMCM-S1-8.1	4.0–8.1 bar
EMCM-S0.3-16.0	2,4–6,6 bar
EMCM-S6-6.6	2,4–6,6 bar
EMCM-S7-6.6	2,4–6,6 bar
EMCM-S9-6.6	2,4–6,6 bar

SPIROPRESS® – MultiControl Modular – DUO, Double pump 2 x 50 %, Single valve 1 x 100 %

EMCM-D1-4.0	1.0–4.0 bar
EMCM-D2-7.8	6.0–7.8 bar
EMCM-D3-10.4	6.0–10.4 bar
EMCM-D4-6.2	2.4–6.2 bar
EMCM-D5-6.2	2.4–6.2 bar
EMCM-D6-10.1	6.0–10.1 bar
EMCM-D8-16.0	8.0–16.0 bar
EMCM-D1-5.6	2.4–5.6 bar
EMCM-D9-11.0	6.0–11.0 bar
EMCM-D1-8.1	6.0–8.1 bar

SPIROPRESS® – MultiControl Modular – DUO/TWIN, Double pump 2 x 50 %, Double valve 2 x 100 %

EMCM-D1-4.0-twin	1.0–4.0 bar
EMCM-D1-5.6-twin	2.4–5.6 bar
EMCM-D1-6.6-twin	2.4–8.1 bar
EMCM-D1-8.1-twin	6.0–8.1 bar
EMCM-D2-7.8-twin	6.0–7.8 bar
EMCM-D3-10.4-twin	6.0–10.4 bar
EMCM-D4-6.2-twin	2.4–6.2 bar
EMCM-D5-6.2-twin	2.4–6.2 bar
EMCM-D6-10.1-twin	6.0–10.1 bar
EMCM-D8-16.0-twin	8.0–16.0 bar
EMCM-D9-11.0-twin	6.0–11.0 bar

SPIROPRESS® – MultiControl Modular – MAXI, Double pump 2 x 100 %, Single valve 1 x 100 %

Art.-No.	Upper working pressure range
EMCM-M1-4.0	1.0–4.0 bar
EMCM-M2-7.8	4.0–7.8 bar
EMCM-M3-10.0	4.0–10.0 bar
EMCM-M4-6.2	2.4–6.2 bar
EMCM-M5-6.2	2.4–6.2 bar
EMCM-M6-10.1	6.0–10.1 bar
EMCM-M8-16.0	8.0–16.0 bar
EMCM-M1-5.6	2.0–5.6 bar
EMCM-M2-6.0	2.0–6.0 bar
EMCM-M9-11.0	6.0–11.0 bar
EMCM-M1-8.1	4.0–8.1 bar
EMCM-M0.3-16.0	8,0–16,0 bar

SPIROPRESS® – MultiControl Modular – MAXI/TWIN. Double pump 2 x 100 %. Double valve 2 x 100 %

EMCM-M1-4.0-twin	1.0–4.0 bar
EMCM-M1-5.6-twin	2.0–5.6 bar
EMCM-M1-8.1-twin	4.0–8.1 bar
EMCM-M2-7.8-twin	4.0–7.8 bar
EMCM-M3-10.0-twin	4.0–10.0 bar
EMCM-M4-6.2-twin	2.4–6.2 bar
EMCM-M5-6.2-twin	2.4–6.2 bar
EMCM-M6-10.1-twin	6.0–10.1 bar
EMCM-M8-16.0-twin	8.0–16.0 bar
EMCM-M2-6.0-twin	2.0–6.0 bar
EMCM-M9-11.0-twin	6.0–11.0 bar
EMCM-M0.3-16.0-twin	8,0–16,0 bar
EMCM-M0-6-6.6-twin	2,4–6,6 bar
EMCM-M7-6.6-twin	2,4–6,6 bar
EMCM-M9-6.6-twin	2,4–6,6 bar

SPIROPRESS® – TopControl Modular – SOLO, Single pump 1 x 100 %, Single valve 1 x 100 %

ETCM-S5.4-15.7	2.0–15.7 bar
ETCM-S4.7-23.5	2.6–23.5 bar
ETCM-S9.1-14.9	2.0–14.9 bar
ETCM-S10.0-23.5	2.6–23.5 bar

SPIROPRESS® – TopControl Modular – DUO, Double pump 2 x 50 %, Single valve 1 x 100 %

ETCM-D10.8-15.7	2.0–15.7 bar
ETCM-D9.4-23.5	2.6–23.5 bar
ETCM-D18.2-14.9	2.0–14.9 bar
ETCM-D20.0-23.5	2.6–23.5 bar

SPIROPRESS® – TopControl Modular – DUO/TWIN, Double pump 2 x 50 %, Double valve 2 x 100 %

ETCM-D10.8-15.7-twin	2.0–15.7 bar
ETCM-D9.4-23.5-twin	2.6–23.5 bar
ETCM-D18.2-14.9-twin	2.0–14.9 bar
ETCM-D20.0-23.5-twin	2.6–23.5 bar

SPIROPRESS® – TopControl Modular – MAXI, Double pump 2 x 100 %, Single valve 1 x 100 %

Art.-No.	Description	max. op. pressure
ETCM-M5.4-15.7		max. op. pressure 2.0–15.7 bar
ETCM-M4.7-23.5		max. op. pressure 2.6–23.5 bar
ETCM-M9.1-14.9		max. op. pressure 2.0–14.9 bar
ETCM-M10.0-23.5		max. op. pressure 2.6–23.5 bar

SPIROPRESS® – TopControl Modular – MAXI/TWIN, Double pump 2 x 100 %, Double valve 2 x 100 %

ETCM-M5.4-15.7-twin		max. op. pressure 2.0–15.7 bar
ETCM-M4.7-23.5-twin		max. op. pressure 2.6–23.5 bar
ETCM-M9.1-14.9-twin		max. op. pressure 2.0–14.9 bar
ETCM-M10.0-23.5-twin		max. op. pressure 2.6–23.5 bar

SPIROPRESS® – MultiControl COOL

EMCC-S1-4.0	MultiControl COOL SOLO	max. op. pressure 1.0–4.0 bar
EMCC-S1-5.6	MultiControl COOL SOLO	max. op. pressure 2.0–5.6 bar
EMCC-D1-4.0	MultiControl COOL DUO	max. op. pressure 1.0–4.0 bar
EMCC-D1-5.6	MultiControl COOL DUO	max. op. pressure 2.0–5.6 bar
EMCC-M1-4.0	MultiControl COOL MAXI	max. op. pressure 1.0–4.0 bar
EMCC-M1-5.6	MultiControl COOL MAXI	max. op. pressure 2.0–5.6 bar

SPIROPRESS® – MultiControl COOL

Art.-No.	Description	Additional description
EMCC-G125	MultiControl COOL expansion vessel	with level measurement
EMCC-G200	MultiControl COOL expansion vessel	with level measurement
EMCC-G300	MultiControl COOL expansion vessel	with level measurement
EMCC-G500	MultiControl COOL expansion vessel	with level measurement
EMCC-Z125	MultiControl COOL supplementary vessel	only overflow line, without level measurement
EMCC-Z200	MultiControl COOL supplementary vessel	only overflow line, without level measurement
EMCC-Z300	MultiControl COOL supplementary vessel	only overflow line, without level measurement
EMCC-Z500	MultiControl COOL supplementary vessel	only overflow line, without level measurement
EMCC-N1	MultiControl COOL post-feed module	quantity controlled feed, ½"
EMCC-Z	MultiControl COOL Connection Set	MCC-Z to MCC-G and MCC-Z to MCC-Z
EMCC-G	MultiControl COOL Connection Set	MCC-G to MCC-_1, suction and overflow line

SPIROPRESS® – MultiControl AUTOFILL

EMCA-S1-2.7	MultiControl AUTOFILL SOLO	filling pressure up to max. 2.7 bar
EMCA-S1-5.2	MultiControl AUTOFILL SOLO	filling pressure up to max. 5.2 bar
EMCA-G640	MultiControl AUTOFILL expansion vessel MCA-G640	
EMCA-G1000	MultiControl AUTOFILL expansion vessel MCA-G1000	
E55390	MultiControl AUTOFILL Connection Set	MCA-G to MCA-_1, suction and circulation line
E55391	MultiControl AUTOFILL Connection Set	MCA-_1 instead of MCF-1/MCC-N1

SPIROPRESS® – SpiroPress Fill

MR0650	SpiroPress Fill 230 V/50	
--------	--------------------------	--

SPIROPRESS® – Expansion vessel for MultiControl Kompact

Art.-No.	Volume	Description
EMCB-Z75	volume 75 litre	only overflow line, without level measurement
EMCB-Z125	volume 125 litre	only overflow line, without level measurement
EMCB-Z200	volume 200 litre	only overflow line, without level measurement
EMCB-Z300	volume 300 litre	only overflow line, without level measurement
EMCB-Z500	volume 500 litre	only overflow line, without level measurement

SPIROPRESS® – Expansion vessel for MultiControl Modular and TopControl Modular

EP0200R	volume 200 litre	elko-mat EG 200M
EP0300R	volume 300 litre	elko-mat EG 300M
EP0500R	volume 500 litre	elko-mat EG 500M
EP0800R	volume 800 litre	elko-mat EG 800M
EP1000R	volume 1,000 litre	elko-mat EG 1000M
EP1500R	volume 1,500 litre	elko-mat EG 1500M
EP2000R	volume 2,000 litre	elko-mat EG 2000M
EP2500R	volume 2,500 litre	elko-mat EG 2500M
EP3000R	volume 3,000 litre	elko-mat EG 3000M
EP4000R	volume 4,000 litre	elko-mat EG 4000M
EP5000R	volume 5,000 litre	elko-mat EG 5000M
EPX100R	volume 10,000 litre	elko-mat EG 10000M

SPIROPRESS® – Supplementary vessels for MultiControl Modular and TopControl Modular

EP0200RS	volume 200 litre	elko-mat EGZ 200M
EP0300RS	volume 300 litre	elko-mat EGZ 300M
EP0500RS	volume 500 litre	elko-mat EGZ 500M
EP0800RS	volume 800 litre	elko-mat EGZ 800M
EP1000RS	volume 1,000 litre	elko-mat EGZ 1000M
EP1500RS	volume 1,500 litre	elko-mat EGZ 1500M
EP2000RS	volume 2,000 litre	elko-mat EGZ 2000M
EP2500RS	volume 2,500 litre	elko-mat EGZ 2500M
EP3000RS	volume 3,000 litre	elko-mat EGZ 3000M
EP4000RS	volume 4,000 litre	elko-mat EGZ 4000M
EP5000RS	volume 5,000 litre	elko-mat EGZ 5000M
EPX100RS	volume 10,000 litre	elko-mat EGZ 10000M

SPIROPRESS® – Intermediate cooling vessel for EV models

Art.-No.	Description
ET0100T1	elko-mat EV 100-10-110 intermediate cooling vessel, PN10, 110 °C
ET0150T1	elko-mat EV 150-10-110 intermediate cooling vessel, PN10, 110 °C
ET0200T1	elko-mat EV 200-10-110 intermediate cooling vessel, PN10, 110 °C
ET0350T1	elko-mat EV 350-10-110 intermediate cooling vessel, PN10, 110 °C
ET0500T1	elko-mat EV 500-10-110 intermediate cooling vessel, PN10, 110 °C
ET0750T1	elko-mat EV 750-10-110 intermediate cooling vessel, PN10, 110 °C
ET1000T1	elko-mat EV 1000-10-110 intermediate cooling vessel, PN10, 110 °C
ET1500T1	elko-mat EV 1500-10-110 intermediate cooling vessel, PN10, 110 °C
ET2000T1	elko-mat EV 2000-10-110 intermediate cooling vessel, PN10, 110 °C
ET3000T1	elko-mat EV 3000-10-110 intermediate cooling vessel, PN10, 110 °C

SPIROPRESS® – Expansion modules and accessories for MultiControl and TopControl

Art.-No.	Description
EMCPB	MultiControl Busmodul Profibus Profibus-Standard DP-V0
EMCPN	MultiControl Busmodul Profinet Profinet IO-Device
EMCMO	MultiControl Busmodul Modbus RTU RS485
EMCWE	MultiControl Webmodul ethernet 100 Mbps, WLAN GH2.4 z 802.11n
EMCSM	MultiControl SMS-Modul
EMCAM	MultiControl Expansion module. "analogue remote signaling"
EMCBM	MultiControl Expansion module. "binary remote message"
EMCBMR	MultiControl Expansion module. "binary remote messages & remote acknowledgment"
EMCF-1	MultiControl post-feed module MCF-1. Quantity controlled feed ½"
EMCF-3	MultiControl post-feed module MCF-3. Quantity controlled feed ¾"
TMA05	Backflow preventer with controllable low pressure zone (½" IG)
TMA06	Backflow preventer with controllable low pressure zone (¾" IG)
EMCB-ZB	MultiControl kompakt Bypass-Set Bypass Kit for MultiControl Kompakt and Modular 1/PN10
E51950	MultiControl contact temperature sensor. Incl. clamping tape (diameter 15–40 mm)
E51951	MultiControl cable temperature sensor. Cable 10 m. incl. immersion sleeve G½". PN10
EMAE-1	MultiControl degassing module MAE-1 Low pressure degassing, ½", suitable for MCM
EMCB-ZC	MultiControl Kompakt connection set MCB-Z. Connection of MCB-Z to MCK (extension)
E51995	drip tray, 840 x 840, 3 spacer, drain connection 50 with siphon
E51996	drip tray, 1200 x 800, 3 spacer, drain connection 50 with siphon
EPCF-1	PicoControl post-feed module ½" post-feed drinking water systems
E51910	MultiControl equipment house made of metal MultiControl Feed temperature sensor incl. Tensioning band (diameter 15–40 mm)

SPIROPRESS® – MWE-module demineralisatie voor suppletiewater

EMVE2	elko-mat MVE 2 Module demineralisation supplementary water
EMWE6	elko-mat MWE 6 Module water softening make-up water
ER-MWE28	elko-mat R-MWE 28 Module water softening, regenerating
E51645	Replacement cartridge for VE ion exchanger to elko-mat MVE 2 and MVE 4
E51614	Replacement cartridge for ion exchanger, elko-mat MWE 6 and MWE 12
E51615	Replacement filter insert for fine filters to elko-mat eder MWE, MVE and R-MWE"
E51616	Filter bowl keys to elko-mat MWE 6 and MWE 12
E51617	Total hardness test kit elko-mat GH100

SPIROPRESS® – Diaphragm safety valve

ACCESSORIES

Art.-No.	Description
E50111	Diaphragm safety valve ½"- 3 bar, max. heating capacity: 50 kW
E50112	Diaphragm safety valve ½"- 3 bar, max. heating capacity: 50 kW
E50113	Diaphragm safety valve ¾"- 3 bar, max. heating capacity: 100 kW
E50512	Diaphragm safety valve ½"- 6 bar, max. heating capacity: 75 kW
E50513	Diaphragm safety valve ¾"- 6 bar, max. heating capacity: 150 kW
E52001	Diaphragm safety valve 1"-3 bar, max. heating capacity: 354 kW
E52002	Diaphragm safety valve 1"-4 bar, max. heating capacity: 436 kW
E52003	Diaphragm safety valve 1"-5 bar, max. heating capacity: 515 kW
E52004	Diaphragm safety valve 1"-6 bar, max. heating capacity: 591 kW
E52005	Diaphragm safety valve 5/4"-3 bar, max. heating capacity: 729 kW
E52006	Diaphragm safety valve 5/4"-4 bar, max. heating capacity: 898 kW
E52007	Diaphragm safety valve 5/4"-5 bar, max. heating capacity: 1,060 kW
E52008	Diaphragm safety valve 5/4"-6 bar, max. heating capacity: 1,216 kW
E52009	Diaphragm safety valve 6/4"-3 bar, max. heating capacity: 949 kW
E52010	Diaphragm safety valve 6/4"-4 bar, max. heating capacity: 1,168 kW
E52011	Diaphragm safety valve 6/4"-5 bar, max. heating capacity: 1,378 kW
E52012	Diaphragm safety valve 6/4"-6 bar, max. heating capacity: 1,582 kW
E52013	Diaphragm safety valve 2"-3 bar, max. heating capacity: 1,322 kW
E52014	Diaphragm safety valve 2"-4 bar, max. heating capacity: 1,626 kW
E52015	Diaphragm safety valve 2"-5 bar, max. heating capacity: 1,920 kW
E52016	Diaphragm safety valve 2"-6 bar, max. heating capacity: 2,203 kW
E52017	Diaphragm safety valve 1"-8 bar, max. heating capacity: 743 kW
E52018	Diaphragm safety valve 5/4"-8 bar, max. heating capacity: 1,529 kW
E52019	Diaphragm safety valve 6/4"-8 bar, max. heating capacity: 1,989 kW
E52020	Diaphragm safety valve 2"-8 bar, max. heating capacity: 2,770 kW
E52021	Diaphragm safety valve 1"-10 bar, max. heating capacity: 889 kW
E52022	Diaphragm safety valve 5/4"-10 bar, max. heating capacity: 1,830 kW
E52023	Diaphragm safety valve 6/4"-10 bar, max. heating capacity: 2,380 kW
E52024	Diaphragm safety valve 2"-10 bar, max. heating capacity: 3,315 kW

SPIROPRESS® – Expansion vessel with fixed pressure and butyl membrane

Art.-No.	Description
EV0002FP06	Expansion vessel with fixed pressure and butyl membrane 2 Litre, 6 bar
EV0008FP06	Expansion vessel with fixed pressure and butyl membrane 8 Litre, 6 bar
EV0012FP06	Expansion vessel with fixed pressure and butyl membrane 12 Litre, 6 bar
EV0018FP06	Expansion vessel with fixed pressure and butyl membrane 18 Litre, 6 bar
EV0024FP06	Expansion vessel with fixed pressure and butyl membrane 24 Litre, 6 bar
EV0035FP06	Expansion vessel with fixed pressure and butyl membrane 35 Litre, 6 bar
EV0060FP06	Expansion vessel with fixed pressure and butyl membrane 60 Litre, 6 bar
EV0080FP06	Expansion vessel with fixed pressure and butyl membrane 80 Litre, 6 bar
EV0100FP06	Expansion vessel with fixed pressure and butyl membrane 100 Litre, 6 bar
EV0150FP06	Expansion vessel with fixed pressure and butyl membrane 150 Litre, 6 bar
EV0200F	Expansion vessel with fixed pressure and butyl membrane 200 Litre, 10 bar
EV0250F	Expansion vessel with fixed pressure and butyl membrane 250 Litre, 10 bar
EV0300F	Expansion vessel with fixed pressure and butyl membrane 300 Litre, 10 bar
EV0450F	Expansion vessel with fixed pressure and butyl membrane 450 Litre, 10 bar

SPIROPRESS® – Expansion vessel with replaceable EPDM bladder

Art.-No.	Description
EV0750REP10	Expansion vessel with replaceable EPDM bladder 750 Litre, 10 bar
EV1000REP10	Expansion vessel with replaceable EPDM bladder 1000 Litre, 10 bar
EV1500REP10	Expansion vessel with replaceable EPDM bladder 1500 Litre, 10 bar
EV2000REP10	Expansion vessel with replaceable EPDM bladder 2000 Litre, 10 bar
EV3000REP10	Expansion vessel with replaceable EPDM bladder 3000 Litre, 10 bar
EV0100REP16	Expansion vessel with replaceable EPDM bladder 100 Litre, 16 bar
EV0150REP16	Expansion vessel with replaceable EPDM bladder 150 Litre, 16 bar
EV0200REP16	Expansion vessel with replaceable EPDM bladder 200 Litre, 16 bar
EV0300REP16	Expansion vessel with replaceable EPDM bladder 300 Litre, 16 bar
EV0500REP16	Expansion vessel with replaceable EPDM bladder 500 Litre, 16 bar
EV0750REP16	Expansion vessel with replaceable EPDM bladder 750 Litre, 16 bar
EV0850REP16	Expansion vessel with replaceable EPDM bladder 850 Litre, 16 bar
EV1500REP16	Expansion vessel with replaceable EPDM bladder 1500 Litre, 16 bar
EV2000REP16	Expansion vessel with replaceable EPDM bladder 2000 Litre, 16 bar
EV3000REP16	Expansion vessel with replaceable EPDM bladder 3000 Litre, 16 bar
EV0050REP25	Expansion vessel with replaceable EPDM bladder 50 Litre, 25 bar
EV0100REP25	Expansion vessel with replaceable EPDM bladder 100 Litre, 25 bar
EV0150REP25	Expansion vessel with replaceable EPDM bladder 150 Litre, 25 bar
EV0200REP25	Expansion vessel with replaceable EPDM bladder 200 Litre, 25 bar
EV0300REP25	Expansion vessel with replaceable EPDM bladder 300 Litre, 25 bar
EV0500REP25	Expansion vessel with replaceable EPDM bladder 500 Litre, 25 bar
EV0850REP25	Expansion vessel with replaceable EPDM bladder 850 Litre, 25 bar
EV1000REP25	Expansion vessel with replaceable EPDM bladder 1000 Litre, 25 bar
EV1500REP25	Expansion vessel with replaceable EPDM bladder 1500 Litre, 25 bar
EV2000REP25	Expansion vessel with replaceable EPDM bladder 2000 Litre, 25 bar
EV3000REP25	Expansion vessel with replaceable EPDM bladder 3000 Litre, 25 bar

EXPANSION VESSELS

SPIROPRESS® – Safety expansion vessel – series N (3 bar)

Art.-No.	Description	
EVN4	elko-flex N4	4 litre, 3 bar
EVN8	elko-flex N8	8 litre, 3 bar
EVN12	elko-flex N12	12 litre, 3 bar
EVN18	elko-flex N18	18 litre, 3 bar
EVN25	elko-flex N25	25 litre, 3 bar
EVN35	elko-flex N35	35 litre, 3 bar
EVN50	elko-flex N50	50 litre, 3 bar
EVN80	elko-flex N80	80 litre, 3 bar
EVN100	elko-flex N100	100 litre, 3 bar
EVNP115	elko-flex NP115	115 litre, 3 bar
EVNP230	elko-flex NP230	230 litre, 3 bar

SPIROPRESS® – Safety expansion vessel – series SG (3 bar)

EVSG120	elko-flex SG120	120 litre, 3 bar
EVSG180	elko-flex SG180	180 litre, 3 bar
EVSG250	elko-flex SG250	250 litre, 3 bar
EVSG330	elko-flex SG330	330 litre, 3 bar
EVSG500	elko-flex SG500	500 litre, 3 bar

SPIROPRESS® – Safety expansion vessel – series COOL (6 bar)

EVCool18	elko-flex Cool 18	18 litre, 6 bar
EVCool25	elko-flex Cool 25	25 litre, 6 bar
EVCool35	elko-flex Cool 35	35 litre, 6 bar
EVCool50	elko-flex Cool 50	50 litre, 6 bar

SPIROPRESS® – Safety expansion vessel – series U (6 bar) with replaceable membrane

EVU18-6	elko-flex U18-6	18 litre, 6 bar
EVU25-6	elko-flex U25-6	25 litre, 6 bar
EVU35-6	elko-flex U35-6	35 litre, 6 bar
EVU50-6	elko-flex U50-6	50 litre, 6 bar
EVU90-6	elko-flex U90-6	90 litre, 6 bar
EVU120-6	elko-flex U120-6	120 litre, 6 bar
EVU200-6	elko-flex U200-6	200 litre, 6 bar
EVU300-6	elko-flex U300-6	300 litre, 6 bar

SPIROPRESS® – Safety expansion vessel – series U (10 bar) with replaceable membrane

EVU15-10	elko-flex U15-10	15 litre, 10 bar
EVU20-10	elko-flex U20-10	20 litre, 10 bar
EVU30-10	elko-flex U30-10	30 litre, 10 bar
EVU60-10	elko-flex U60-10	60 litre, 10 bar
EVU120-10	elko-flex U120-10	120 litre, 10 bar
EVU180-10	elko-flex U180-10	180 litre, 10 bar
EVU240-10	elko-flex U240-10	240 litre, 10 bar
EVU300-10	elko-flex U300-10	300 litre, 10 bar

SPIROPRESS® – Safety expansion vessel – series Solar (6 bar) for solar installations

Art.-No.	Description	
EVSolar18	elko-flex Solar 18	18 litre, 6 bar
EVSolar25	elko-flex Solar 25	25 litre, 6 bar
EVSolar35	elko-flex Solar 35	35 litre, 6 bar
EVSolar50	elko-flex Solar 50	50 litre, 6 bar
EVSolar90	elko-flex Solar 90	90 litre, 6 bar
EVSolar120	elko-flex Solar 120	120 litre, 6 bar
EVSolar200	elko-flex Solar 200	200 litre, 6 bar
EVSolar300	elko-flex Solar 300	300 litre, 6 bar

SPIROPRESS® – Safety expansion vessel – series San (10 bar) for drinking water in non-flowed design

EVSan2	elko-san San 2	2 litre, 10 bar
EVSan15	elko-san San 15	15 litre, 10 bar
EVSan20	elko-san San 20	20 litre, 10 bar
EVSan30	elko-san San 30	30 litre, 10 bar
EVSan60	elko-san San 60	60 litre, 10 bar
EVSan120	elko-san San 120	120 litre, 10 bar
EVSan180	elko-san San 180	180 litre, 10 bar
EVSan240	elko-san San 240	240 litre, 10 bar
EVSan300	elko-san San 300	300 litre, 10 bar

SPIROPRESS® – Safety expansion vessel – series San (10 bar) for drinking water in flow-through design

EVSan20D	elko-san San 20D	20 litre, 10 bar
EVSan30D	elko-san San 30D	30 litre, 10 bar
EVSan90D	elko-san San 90D	90 litre, 10 bar
EVSan120D	elko-san San 120D	120 litre, 10 bar
EVSan60D	elko-san San 60D	60 litre, 10 bar
EVSan300D	elko-san San 300D	300 litre, 10 bar
EVSan240D	elko-san San 240D	240 litre, 10 bar
EVSan180D	elko-san San 180D	180 litre, 10 bar

SPIROPRESS® – Safety expansion vessel – series C (3 bar) with replaceable membrane

EVC600	elko-flex C600	600 litre, 3 bar
EVC800	elko-flex C800	800 litre, 3 bar
EVC1000	elko-flex C1000	1,000 litre, 3 bar

SPIROPRESS® – Safety expansion vessel – series CV (5 bar) with replaceable membrane

EVCV120	elko-flex CV120	120 litre, 5 bar
EVCV180	elko-flex CV180	180 litre, 5 bar
EVCV250	elko-flex CV250	250 litre, 5 bar
EVCV330	elko-flex CV330	330 litre, 5 bar
EVCV600	elko-flex CV600	600 litre, 5 bar

SPIROPRESS® – Accessories for expansion vessels

E50110	maintenance unit ¾" a/a, elko-flex WE ¾" a/a
E50100	Set of 2 maintenance units ¾" a/a, elko-flex WE ¾" a/a
E50207	maintenance unit 1" a/i, elko-flex WE 1" a/i
E50200	Set of 2 maintenance units 1" a/i, elko-flex WE 1" a/i
E50307	maintenance unit ¾" a/i, elko-flex WE ¾" a/i
E50120	Digital test gauge with display – test range: 0-9 bar

DEMINERALIZATION

SPIROPURE®



Maintains and improves
system water quality



Optimises efficiency of the
total installation or process



Supports functioning of
other Spirotech solutions



Quick and easy
installation

All images used are for illustrative purposes only. Individual features like material used (i.e. brass or steel) may vary, as may guarantee.

SPIROPURE® – Filling stations for demineralization

Art.-No.	Description	Resin content [ltr]
G61.556	SpiroPure HomeFill Basic	0,75
G61.557	SpiroPure HomeFill XL	1,5
G61.558	SpiroPure HomeFill Duplex	2 x 1,5
G61.679	SpiroPure HomeFill Basic OFK	0,75
G61.680	SpiroPure HomeFill XL OFK	1,5

 SPIROPLUS
HOMEFILL BASIC

SPIROPURE® – Mobile filling stations (bypass)

G61.561	SpiroPure ProFill 9.5	9,5
G61.562	SpiroPure ProFill 23.0	23,0
G61.563	SpiroPure ProFill Advanced 23.0	23,0
G61.687	SpiroPure ProFill Advanced 46.0	46,0
G61.681	SpiroPure ProFill 9.5 Small	9,5
G61.682	SpiroPure ProFill 23.0 Small	23,0

 SPIROPLUS
PROFILL 23.0

SPIROPURE® – Supplementation

G61.683	SpiroPure EcoFill LED Mini	6,0
G61.684	SpiroPure EcoFill LED Small	9,5
G61.685	SpiroPure EcoFill LED Big	23,0
G61.686	SpiroPure EcoFill LED Tall	46,0

SPIROPURE® – Refill cartridges

G61.564	Refill for: G61.562, G61.563	23,0
G61.565	Refill for: G61.561	9,5
G61.559	Refill for: G61.556	0,75
G61.560	Refill for: G61.557, G61.558	1,5
G61.688	SpiroPure Fill Set light	1,5
G61.689	SpiroPure Fill Set	3,0

FLUSHING AGENTS AND ADDITIVES

SPIROPLUS®



Maintains and improves system water quality



Optimises efficiency of the total installation or process



pH-neutral cleaners



For cleaning, sealing and protecting the system



Supports functioning of other Spirotech solutions



Prevents damage and malfunction

All images used are for illustrative purposes only. Individual features like material used (i.e. brass or steel) may vary, as may guarantee.

SPIROPLUS®



SPIROPLUS – PROTECTION FROM THE INSIDE

SpiroPlus products are developed specifically for use in heating, cooling and process installations. Combined with our first class hardware, SpiroPlus products improve and maintain the quality of the installation fluid and the efficiency of the entire installation or process.

SPIROPLUS FLUSHING AGENTS AND ADDITIVES

Today's equipment is more sensitive to the make-up and quality of system water. Many manufacturers are even specifying water quality requirements as a precondition for their guarantees.

SpiroPlus flushing agents and additives are designed to bring and keep system fluid and the system itself in top condition. Pressurisation is optimised and potential deaeration and dirt separation problems are solved and prevented in both existing and newly constructed systems. Rules, regulations and preferences concerning additives for installation fluids are changing. An important goal is to improve the total system efficiency and by doing that, to reduce energy consumption. Another reason is that modern equipment is much more sensitive to the composition and the quality of the system fluid and the effects of it. A number of boiler manufacturers even set requirements regarding the fluid quality connected to their guarantee conditions.

DEMINERALISATION OF HEATING WATER

Demineralisation of heating water not only effectively prevents hardness deposits in the heating system, it also helps prevent corrosion. However, unfavourable pH changes that can occur after system commissioning are often underestimated. This particularly applies if the pH value needs to remain within a narrow range, as with aluminium materials (8.2–8.5). All Spirotech filling equipment and refilling stations use a special mixed-bed resin. The resin not only removes residual hardness and dissolved salts from the heating water, it also stabilises the pH. This avoids the need to check the heating water after 8 to 12 weeks.

GUARANTEED SYSTEM FLUID QUALITY

The SpiroPlus range offers flushing agents for specific actions as well as additives that remain active inside an installation. Whether you're cleaning a system prior to installation, protecting it from frost, or removing dirt, contaminants, calcium, air or corrosion, Spirotech has a solution. The full line of SpiroPlus fluids includes a mild cleaner, power cleaner (both pH-neutral), lime cleaner, sealant, protector and a wide range of anti freeze and glycol mixtures. All these products facilitate quality improvement and preservation of fluid quality. SpiroPlus Protector and SpiroPlus AntiFreeze HC even exceed the EU REACH requirements which have been adopted to protect human health and the environment.

We also develop custom additives and fluids, depending on the requirements for a specific system or process. Experts working at our specialised lab can offer you the best possible advice in every situation. Spirotech offers an extensive range of solutions for system fluid analysis and conditioning in HVAC and process systems. This includes accessories, additives and advice targeted at reducing faults, wear and maintenance as well as maximising system performance and lower energy consumption.

SPIROPLUS® – Flushing agents and additives

STANDARD

Art.-No.	Description	Volume [ltr]
CD001 CD010 CD020	SpiroPlus Mild Cleaner, Dirt Dissolver	1.0 10.0 20.0
CC001 CC010	SpiroPlus Power Cleaner, Power Dirt Dissolver	1.0 10.0
CL001 CL010	SpiroPlus Lime Cleaner, Descaler	1.0 10.0
CS001	SpiroPlus Sealer, Leak Sealer	1.0
CH001 CH010 CH020	SpiroPlus Protector, Corrosion Protector	1.0 10.0 20.0
CA020/A10 CA0200/A10 CA01000/A10	SpiroPlus AntiFreeze HC, Frost Protector	29.0 190.0 1,000.0
CB001 CB010	SpiroPlus Non-oxidizing biocide	1.0 10.0



SPIROPLUS MILD CLEANER



SPIROPLUS PROTECTOR

SPIROPLUS® – Accessories

ACCESSORIES

Art.-No.	Description	Weight [ltr]
G18.660	Cleaner Test Strips EDTA	0.19
G18.678	SpiroPlus test strips water hardness	0.10
G19.262	SpiroPlus Protector test strips	0.17
CTA0109	SpiroCare Prolab Analysis (water analysis)	0.50
CTA1111	SpiroCare System Analysis	0.40
CTA1309	SpiroCare System Analysis	0.20
CTF075	Flush adaptor (for connecting SpiroTrap MB3, SpiroVent RV2)	0.42
UP022	SpiroTrap MB3 UE022WJ + 1 SpiroPlus Power Cleaner CC001 + 1 SpiroPlus Protector CH001	4.60
UP028	SpiroTrap MB3 UE028WJ + 1 SpiroPlus Power Cleaner CC001 + 1 SpiroPlus Protector CH001	4.80
G18.789	SpiroPlus Refractometer	0.42
G18.791	SpiroPlus Pocket Combimeter pH + EC + TDS	0.17



Have you also thought of a dirt separator, automatic air vent (AAV) and microbubble deaeration? Learn more on page 12 and 14.

SPIROCARE® – Analysis and advice



As the leading expert in system water quality, Spirotech offers an easy to use analysis service that provides installers, homeowners, local authorities and housing associations with professional lab verifications.

MAKING ANALYSIS EASY AND VALUABLE

SpiroCare ProLab Analysis is an easy-to-use kit for collecting water samples and system fluid information. Sample shipment costs, analysis and report creation are all included in the purchasing price. Select your language, fill in the printed or online form and send your samples to Spirotech's specialised laboratory in the prepaid envelope provided. After receipt of the samples, results of the analysis sent by email within a few working days, allowing rapid and efficient continuation of work on projects. Spirotech is dedicated to ensuring reliable and enduring performance, so the report does not only include the water analysis, but also proposes possible actions or adaptations. If required, specialised analysis and custom advice are available. SpiroCare ProLab Analysis can be used to check water quality during boiler or radiator replacement, as a pre- or post-flush check or as a status checkup.

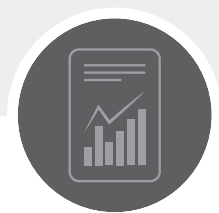

REPORT

Furthermore, SpiroCare ProLab Analysis makes guarantee application procedures easier, as an increasing number of manufacturers require water quality analysis to be carried out before issuing a guarantee.

OTHERS



Insulation sets



Flushing kit for
domestic heating systems



System analysis
products



Additional
accessories

All images used are for illustrative purposes only. Individual features like material used (i.e. brass or steel) may vary, as may guarantee.

SPIROTECH® – Insulation Sets

INSULATION SETS

Art.-No.	Description	Suitable for	Weight [kg]
TAB050	Insulation Set SpiroTop	AB050 / AB050/030	0.18
TAR200	Insulation Set for 2" horizontal connection	AA200 / AE200	0.58
TUR100	Insulation Set for universal connection	UE022WH, UE022WHA01, UE028WH, UE075WH, UE100WH, UE022WJ, UE028WJ, UE075WJ, UE100WJ, UA022W, UA028W, UA075W	0.22
TUR125	Insulation set for 1 1/4" universal connection	UE125WJ, UA125W	0.30
TUR150	Insulation set for 1 1/4" universal connection	UE150WJ, UA150W	0.30
TUR200	Insulation set for 2" universal connection	UE200WJ, UA200W	0.30
TAR100V	Insulation set for vertical connection	AA022V, AA075V, AA100V, AE022V, AE022VM, AE075V, AE100V	0.18
TAA150	Insulation Set Air Brass	AA022, AA075, AA100, AA125, AA150	0.17
TAE150	Insulation Set Dirt Brass	AE022, AE075, AE100, AE125, AE150	0.15
TBX050	Insulation Set SpiroCross Steel	XC050F/L	3.60
TBX065	Insulation Set SpiroCross Steel	XC065F/L	3.70
TBX080	Insulation Set SpiroCross Steel	XC080F/L	7.10
TBX100	Insulation Set SpiroCross Steel	XC100F/L	7.60
TBX125	Insulation Set SpiroCross Steel	XC125F/L	10.00
TBX150	Insulation Set SpiroCross Steel	XC150F/L	10.80
TAX150	Insulation Set Cross Brass	AX100/125/150	0.20
TB050	Insulation Set Steel	BA050F/L, BA065F/L, BE050F/L, BE065F/L, BE050FM/LM, BE065FM/LM	1.54
TB080	Insulation Set Steel	BA080F/L, BA100F/L, BE080F/L, BE100F/L, BE080FM/LM, BE100FM/LM	2.45
TB125	Insulation Set Steel	BA125F/L, BA150F/L, BE125F/L, BE150F/L	5.42
TB125A01	Insulation Set for SpiroTrap Magnet DN 125 + 150	BE125FM/LM, BE150FM/LM	5.42

SPIROTECH® – Flush connector and other accessories

Art.-No.	Description	Additional information	Weight
			[kg]
TMA05	Backflow preventer with controllable low pressure zone (½" IG)	Products with automatic refill	1.17
TMA06	Backflow preventer with controllable low pressure zone (¾" IG)	Products with automatic refill	1.17
CTR075	SpiroPlus RapidCleanse	Camlock or ¾"	9.00
G14.452	pH Indicator Paper	-	0.20
G18.660	Cleaner Test Strips EDTA	-	0.20
G18.678	SpiroPlus test strips water hardness	-	0.10
G19.262	Protector test strips	-	0.20
G18.789	Refractometer	-	0.40
G18.791	Pocket Combimeter pH + EC + TDS	-	0.20
CTA0109	SpiroCare Prolab Analysis (water analysis)	designed for domestic installations (incl. shipping)	0.50
CTA1111	SpiroCare System Analysis	designed for commercial installations (2 x 250 ml bottles) – excl. shipping	0.20
CTA1309	SpiroCare System Analysis	designed for commercial installations (6 x 250 ml bottles) – excl. shipping	0.40
CTF075	Flush adaptor (for connecting SpiroTrap MB3, SpiroVent RV2)	details under SpiroPlus	0.40

ACCESSORIES

SPIROTECH
Accessories



TAB050



TAR200



TAR100V



TUR100



TAA150



TBX065



TBX100



TAX150



TUE100



TB080



SPIROPLUS
POCKET COMBINER



FLUSH CONNECTOR



SPIROPLUS
PACK



SPIROPLUS
pH INDICATOR PAPER



SPIROPLUS
RAPIDCLEANSE



SPIROCARE PROLAB
ANALYSIS



SPIROCARE SYSTEM ANALYSIS

SPIROTECH® bv Head Office

Postbus 207
5700 AE Helmond

Churchillaan 52
5705 BK Helmond

T +31 (0) 492 578 989
F +31 (0) 492 541 245
info@spirotech.com

Bank: ABN-AMRO Bank
BIC: NL23ABNA052.31.72.168
Swift: ABNANL2A
BTW: NL-007020995 B01
HR nr: 17061117, Eindhoven, NL

DISCLAIMER

Modifications and printing/typographic errors reserved. Valid from: 01.01.2020

For further details on lead times, product availability, costs, terms and conditions, please visit our website.

© Copyright Spirotech bv

No part of this publication may be used without prior written permission from Spirotech bv.

www.spirotech.com

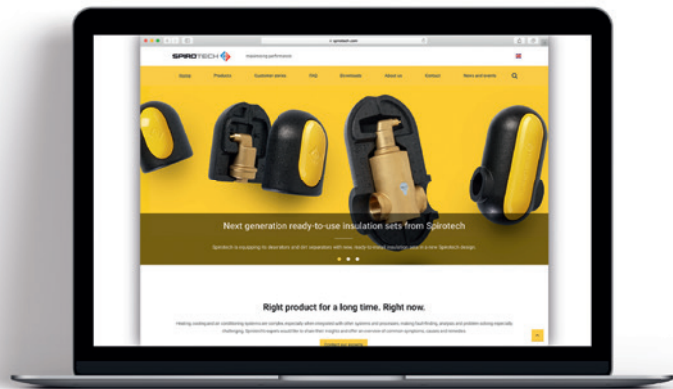

Maximising Performance for You

Spirotech is the leading expert in system water quality. We're a family-owned company with over 60 years of experience in developing solutions to prevent and remove air and dirt in HVAC and process systems, helping save energy, increase comfort, reduce wear and tear and maximises uptime. Our proven reliable standard and customised solutions boost performance and protect investments. With our partners, suppliers and investors we create value with quality solutions in residential and non-residential buildings as well as industrial processes. Spirotech is represented by an extensive network of selected importers in over 70 countries.

VISIT OUR WEBSITE AND FIND THE RIGHT SOLUTION

Heating, cooling and air conditioning systems are complex, especially when integrated with other systems and processes, making fault-finding, analysis and problem solving especially challenging. Spirotech's experts would like to share their insights and offer an overview of common symptoms, causes and remedies.

Spirotech Head Office

Postbus 207
5700 AE Helmond, NL
T +31 (0) 492 578 989
F +31 (0) 492 541 245
www.spirotech.com
info@spirotech.com



Maximising Performance for You