







ACCESSORIES ON REQUEST

MODELS	DESCRIPTION	CODE	PRODUCT	
	C 1.5 Electronic speed controller 1.5 A	12966	11150 - 11201 - 11202 - 11222 - 11301 - 11302 - 11321 - 11322 - 11401 - 11402 - 11421 - 11422	
	SCNRB Electronic speed controller built-in	12971	11150 - 11201 - 11202 - 11221 - 11222 - 11301 - 11302 - 11321 - 11322 - 11401 - 11402 - 11421 - 11422	
	SCB KIT Bult-in controller adaptor for C 1.5	22481	12966	
	F KIT Kit to window-mount	100/4"	22131	11201 - 11202 - 11203 - 11211 - 11212 - 11681 - 11682 - 11221 - 11222 - 11223 - 11231 - 11232 - 11683 - 11684 - 11616 - 11614 - 11646
		120/5"	22132	11301 - 11302 - 11311 - 11312 - 11781 - 11782 - 11783 - 11321 - 11322 - 11331 - 11332 - 11741 - 11746 - 11784 - 11692
		150/6"	22133	11401 - 11402 - 11411 - 11412 - 11881 - 11882 - 11421 - 11422 - 11431 - 11432 - 11851 - 11856 - 11883 - 11884 - 11698
	GFI (Grey Fixed Grille)	100/4"	22010	11150 - 11153 - 11201 - 11202 - 11203 - 11211 - 11212 - 11681 - 11682 - 11221 - 11222 - 11223 - 11231 - 11232 - 11683 - 11684 - 11616
		120/150	22020	11301 - 11302 - 11311 - 11312 - 11781 - 11782 - 11783 - 11321 - 11322 - 11331 - 11332 - 11784 - 11692 - 11401 - 11402 - 11411 - 11412 - 11881 - 11882 - 11421 - 11422 - 11431 - 11432 - 11883 - 11884 - 11698
		GFI 10	22011	
	S Kit Ceiling kit	100/4"	22154	11150 - 11153 - 11201 - 11202 - 11203 - 11211 - 11212 - 11681 - 11682 - 11221 - 11222 - 11223 - 11231 - 11232 - 11683 - 11684 - 11616
		120/5"	22155	11301 - 11302 - 11311 - 11312 - 11781 - 11782 - 11783 - 11321 - 11322 - 11331 - 11332 - 11784 - 11692
		150/6"	22156	11401 - 11402 - 11411 - 11412 - 11881 - 11882 - 11421 - 11422 - 11431 - 11432 - 11883 - 11884 - 11698
	GA	12V	22150	11203 - 11223
		12V T	22151	11203 - 11223

Accessories on request (description and technical data on page 158)

F KIT - KIT TO WINDOW-MOUNT

Technical data and dimensions of the "product+kit".

MODELS	KIT	CODE	W	A	RPM	MAX AIRFLOW		Lp dB(A) 3 m	MAX °C	Kg
						m³/h	l/s			
M 100/4"	F 100/4"	22131	18	0.10	2300	85	23.6	38	50	0.85
M 120/5"	F 120/5"	22132	20	0.12	2000	140	38.9	40.5		1.15
M 150/6"	F 150/6"	22133	30	0.15	1950	280	77.8	44.5		1.56

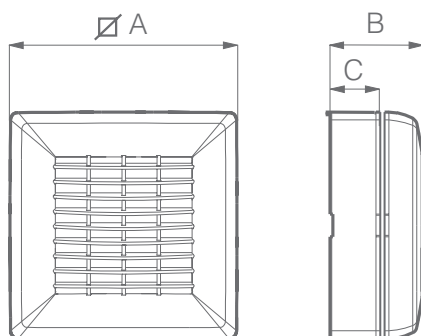

MODELS	∅ A	B	C	∅ GLASS HOLE	THICKNESS
M 100/4"	158	69	22	123 ÷ 128	20
M 120/5"	179	80	33	143 ÷ 148	
M 150/6"	213	87	40	178 ÷ 183	

Dimensions (mm)