



Design: F. Trabucco & Associates



PUNTO FILO RANGE

Wall axial fans **LONG LIFE 30.000 h**

For intermittent or continuous ventilation of bathrooms, toilets, kitchens or utility rooms in domestic or commercial properties.

- **21 models:** from 90 to 150 diameters, standard, timer, long life versions.
- Integral backdraught shutter: already installed on the appliance, it prevents unwanted air from getting back in when the appliance is switched off.
- Very silent.
- Quick and easy installation.
- Eco-Friendly: it guarantees a low environmental impact.
- Only 17 mm thickness.
- **Punto Filo T-HCS:** 3 models.
Adjustable Relative Humidity threshold at 60%, 70%, 80%, 90% by mean of a slide switch during installation.
- Protection rating: IPX4.
- Insulation class: II

RANGE

TIMER

PIR Passive Infrared

T-HCS Humidity Control System - Timer

Ø 90		11122 MF 90/3.5"	11126 MF 90/3.5" T		
	LONG LIFE 30.000 h				
Ø100		11123 MF 100/4"	11127 MF 100/4" T		
	LONG LIFE 30.000 h	11131 MF 100/4" LL	11135 MF 100/4" T LL	11185 MF 100/4" PIR LL	11139 MF 100/4" THCS LL
Ø 120		11124 MF 120/5"	11128 MF 120/5" T		
	LONG LIFE 30.000 h	11132 MF 120/5" LL	11136 MF 120/5" T LL	11186 MF 120/5" PIR LL	11149 MF 120/5" THCS LL
Ø 150		11125 MF 150/6"	11129 MF 150/6" T		
	LONG LIFE 30.000 h	11133 MF 150/6" LL	11137 MF 150/6" T LL	11187 MF 150/6" PIR LL	11176 MF 150/6" THCS LL



DIMENSIONS

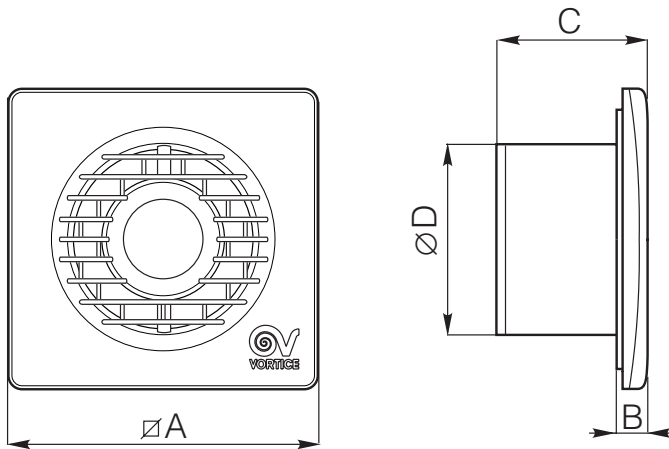

MODELS	∅ A	B	C	∅ D
MF 90/3.5"	159	17	77	92.5
MF 100/4"				98
MF 120/5"	179		89	119
MF 150/6"	214		96	156



Dimensions (mm)

PERFORMANCE CURVES

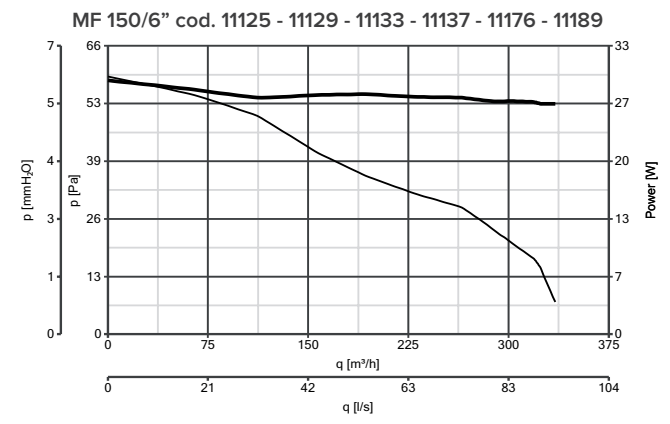
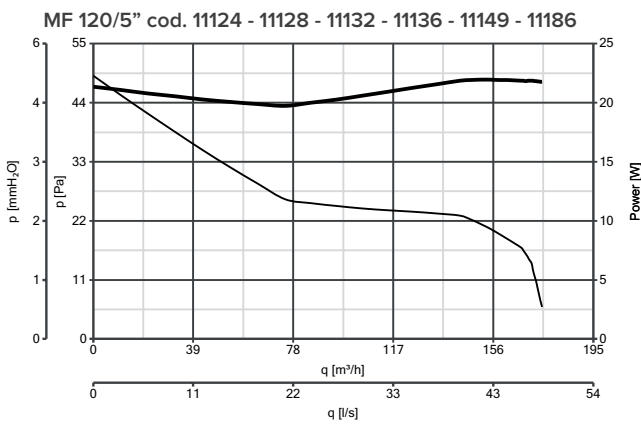
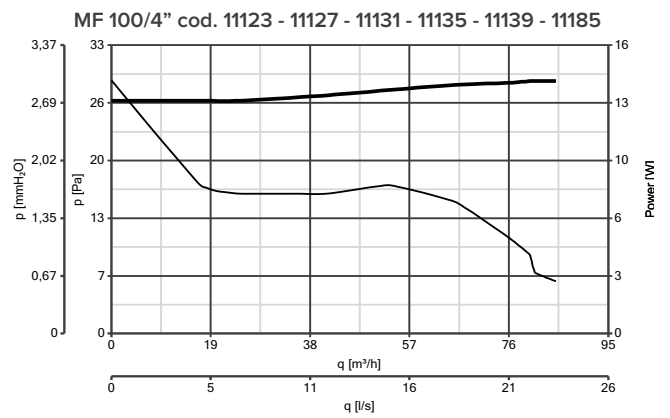
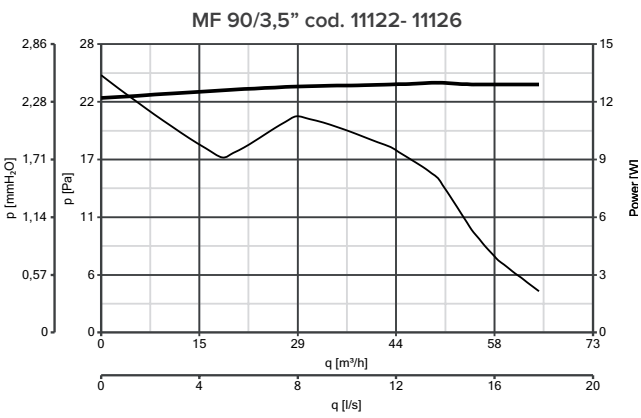
— Power consumption — Delivery



ACCESSORIES ON REQUEST

MODELS	DESCRIPTION	CODE	PRODUCT	
	C 1.5 Electronic speed controller 1.5 A	12966	11122 - 11123 - 11131 - 11124 - 11132 - 11125 - 11133	
	SCB KIT Built-in controller adaptor for C 1.5	22481	12966	
	SF KIT - Ceiling kit	90 - 100	22162	11122 - 11126 - 11123 - 11131 - 11127 11135 - 11185 - 11139
		120	22163	11124 - 11132 - 11128 - 11136 - 11186 - 11149
		150	22164	11125 - 11133 - 11129 - 11137 - 11187 - 11176

Accessories on request (description and technical data on page 146)

APPLICATIONS

