

ADRCV24100TD

100W 24V Constant Voltage
Triac Dimmable LED Driver



PRODUCT FEATURES

- Compatible with Trailing & Leading Edge Dimmers
- Tough Polycarbonate Body
- Loop In - Loop Out Design
- Large Terminals
- Over Load Protection
- No Load Protection
- Short Circuit Protection
- Thermal Protection
- Overcurrent Protection

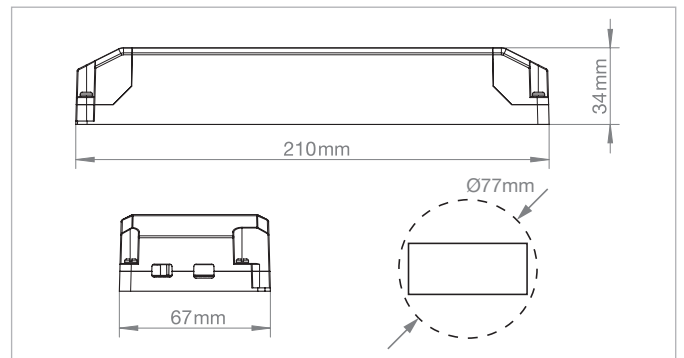

TECHNICAL SPECIFICATIONS

Product Code	ADRCV24100TD	Switching cycles	100,000
Operating Voltage	220-240VAC	Ingress Protection	IP20
Operating Current (A max)	0.495	Ambient Operating Temperature (°C)	-20°C ~ +45°C
Max Output Power	100W	Input Frequency (Hz)	50-60Hz
Output Current (Max)	4.2A	Guarantee	3 Years
Output Voltage (Max)	24V	Dimmable	Yes
PF	0.95	Dimming Mode (Trailing or Leading)	Trailing & Leading
Efficiency %	88	Output type	Constant Voltage
No Load Power (W)	<0.5W	Life Time	50,000 hours
Class	II	Start Up Time	<0.5s
Body Material	Polycarbonate	Inrush Current A pk (TH & ms)	20 (th=100µs)
Frame Colour	White		

