

1619A00WF50001

**Robert Bosch Limited**  
Power Tools Division  
PO Box 98, Uxbridge,  
Middlesex, UB9 5HN  
United Kingdom  
[www.boschpowertools.co.uk](http://www.boschpowertools.co.uk)



1 619 A00 WF5 - en - PT-AC/MKB1 - Printed in Germany - Imprimé en Allemagne.  
Subject to technical alterations. Liability for printing errors is not accepted.  
Valid from: 01.01.2013  
Segment Catalogue 2 - 1st edition  
Printed at Werbedruck GmbH Horst Schreckhase, Dörnbach 22, 34286 Spangenberg, Germany.

2 CBGB

# Bosch: Focusing on progress.

**The concrete and masonry range.**



**BOSCH**

Invented for life

Hammer and stone drilling, chiselling



**BOSCH**

Invented for life

# Accessory range

## Overview

Innovative and efficient products ensure successful sales. The research and development departments at Bosch work to continuously develop and optimise accessories in line with the needs of professionals.



### The metal drill bit range

Metal and wood drilling  
Accessories for screwdriving  
Machine accessories  
Cordless working  
Work safety



### The circular saw blade range

Circular sawing  
Routing



### The concrete and masonry range

Hammer drilling  
Masonry drilling  
Chiselling



### The jigsaw blade range

Jigsawing  
Sabre sawing  
Multi-cutters  
Holesawing



### The diamond accessory range

Diamond cutting  
Diamond grinding heads  
Diamond drilling



### The cutting and grinding disc range

Sanding and polishing  
Cutting and grinding  
Brushing



#### Bosch Customer Service

Have any questions about our products and applications?

Tel.: 0844 736 0109

Fax: 0844 736 0146

Mon - Fri: 8:30 - 17:00

[boschservicecentre@uk.bosch.com](mailto:boschservicecentre@uk.bosch.com)



Calls are charged at 4 pence per minute from a BT landline, call charges from other networks will vary and mobiles may be significantly more.

This number connects you to the Bosch application adviser team.

It is there to answer your queries regarding technical matters and for quick and user friendly customer service.

Outside office hours an answer phone will take your message.

# Table of contents

	<b>Drilling</b>	
	Overview	6
	<b>Cylindrical shank</b>	
	CYL-5	17
	CYL-3	20
	CYL-1	24
	CYL-9 Multi Construction	27
	CYL-9 Ceramic	30
	<b>SDS-plus shank</b>	
	SDS-plus-7	33
	SDS-plus-5	37
	SDS-plus-9 Rebar Cutter	42
	SDS-plus-9 Core Cutter	43
	<b>SDS-max shank</b>	
	SDS-max-7	46
SDS-max-9 Natural Stone	49	
SDS-max-9 Break Through	50	
SDS-max-9 Core Cutter	52	
	<b>Chiselling</b>	
	Overview	56
	SDS-plus chisels	61
	SDS-max chisels	63
	Hex shank chisels	65
	<b>General information</b>	
	Index	69
	Pictograms	4
	Date of production and packing	71
	Packaging	72

# Packaging information system

## Technical information/applications

### Material



Concrete



Concrete 2



Natural stone



Tiles



Masonry



Marble



Granite



Aluminium



Hard and soft wood

### Properties/Advantages



Cylindrical shank with wings



Cylindrical shank



SDS-plus shank



SDS-max shank



Hex shank



activeteq



Power Grip System – 100% power transfer



2-cutter



5-cutter



Long lifetime



3 times longer lifetime



Fast drilling



Easy drilling



Precise drilling



Test mark from Prüfgemeinschaft Mauerbohrer e.V. (masonry drill bit testing association) (PGM)



Do not drill with impact

### Safety



Wear protective glasses



Wear dust mask



# Drilling



## Bosch:

# Pioneer in drilling for maximum efficiency

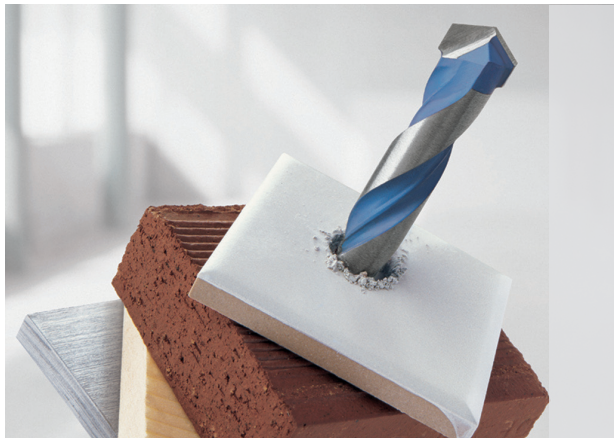

As a leader in innovation, Bosch continually sets new standards with drill bits 'Made in Germany'. From the invention of the SDS system to the unique in-house production of carbide, Bosch always stands out from the competition. Due to groundbreaking innovations, drilling is made more efficient.

In 1975 Bosch developed the SDS-plus system, which has been an industry standard for precise and reliable drilling ever since. SDS-plus is known as the drill bit insertion system that guarantees better power transfer and unlike other systems on the market, enables fast changing of drill bits and chisels.

Other pioneering innovations include the first 4 cutter SDS-max drill bit – Quadro X and the first bit with 4 flute technology -SDS-plus S4. Our focus has always been on developing products to combine efficient work and high quality.

Today, Bosch are the only manufacturer who can control the blend of carbide they use. This is in order to achieve the ideal balance between hard and soft tungsten carbide. In addition, the innovative diffusion bonding technology ensures that the flute joins the carbide, therefore meeting the highest customer requirements.

What Bosch can offer is a broad selection of different types of drill bits with outstanding longevity and maximum reliability.

Invented by Bosch, for maximum efficiency.

# Make good drill bits great –

## key properties that affect the quality of a drill bit

There are a number of drill bits with a variety of different properties. This makes it difficult to judge which bit is suitable for your requirements. Below is a list of key properties and their explanations.



### Key properties

### What features contribute to a high quality drill bit

#### Long life/Robustness

#### Carbide

High quality raw material and manufacturing process.

#### Steel

High-alloy steel and optimised hardening technology. In addition to this, fast material removal through the flute must be ensured to prevent heat development and the resulting wear.

#### Clean, precise drilling

#### Drill bit head

Active centring for precise drilling in concrete.

#### Cutting edges

The number of cutters determines which material can be drilled into (e.g. 4-cutter for rebar).

#### Material extraction

#### Flute

Diameter optimised design to reduce dust explosions.

#### Mounting system

#### Shank system

SDS-plus/SDS-max and the new Power Grip System ensure that 100 percent of the machine's power is transferred to the drill bit, which also makes it easier to change the bit.

# The first point of contact: the drill bit tip



The tip has two main functions:

1. Centring the drill bit to prevent it from wandering.
2. Grinding the concrete into fine dust which can be easily removed from the drilled hole.

## Centring tip

The exposed centre area of the cutting edge is for active centring and provides guidance while drilling.

- ▶ Without a ground tip or centring area, the bit will wander on glazed surfaces and as a result the dimension of the hole would no longer be in the tolerance range.



## Cutting edge

Shaped cutters ensure: high performance; largest demolition force; fast speed and long lifetime.

- ▶ The application and material define if the cutters need to be shaped or diamond ground to determine the performance of the drill bits.



## Relief grooves (V on cutting edge)

The dust is directed into the flute to avoid a jam in the bottom of the borehole.

- ▶ High quality 2-cutter drill bits feature relief grooves to ensure efficient work progress.







Bosch drill bits bear the test mark from Prüfgemeinschaft Mauerbohrer e.V. (masonry drill bit testing association) (PGM). **The PGM seal is the guarantor for:** compliance with tight tolerances, exact drilled holes and firm hold of fixings

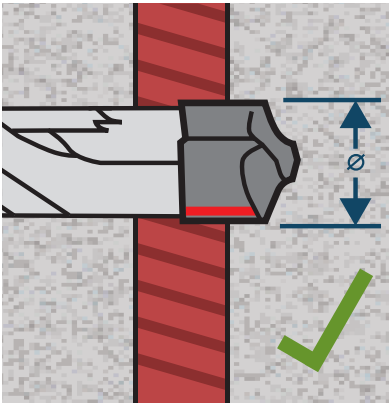

#### Wear mark

The visibility of the wear mark indicates if the diameter of the hole is still in tolerance for metal anchor setting.

- ▶ High quality drill bits feature wear marks which keeps the costs per drilled hole low.



# High impact on lifetime: the drilling head

The composition and quality of the carbide has an influence on the number of holes the drill bit can drill within the tolerance range which ultimately affects the lifetime of the bit. The last production step of the bonding or brazing technology is equally important, it is used to bond the carbide to the drill bit's flute.

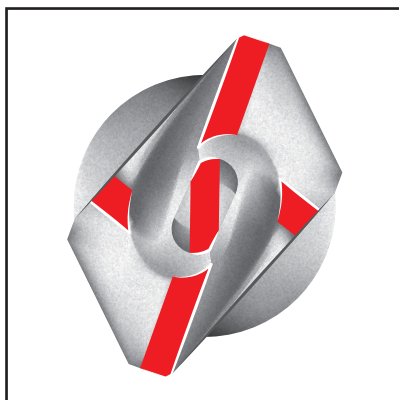

## Carbide design

The design of the carbide affects the lifetime of the drill bit and defines the variety of materials that can be cut.

- ▶ The higher the number of cutters the better the bit will drill into hard materials and reinforced concrete.

### There are 4 different types of cutters:

#### 2-cutter, brazed

= Standard lifetime

#### 3- or 4-cutter, brazed

- ▶ Less wear than 2-cutters
- = Longer lifetime, less jamming in rebar

#### 3- or 4-cutter full head, bonded

- ▶ Twice the performance of 2-cutters in hard materials
- ▶ Twice as many cutting edges as 2-cutters
- = Longer lifetime, less jamming in rebar

#### 5-cutter full head, diffusion bonding

- ▶ Performance in hard materials is 3 times better than 2-cutters = Best lifetime
- ▶ Twice as many cutting edges as 2-cutters
- = High drilling speed
- ▶ The cutter construction ensures better performance without jamming in rebar than 3 or 4-cutters
- = 3 times longer lifetime/best wear resistance

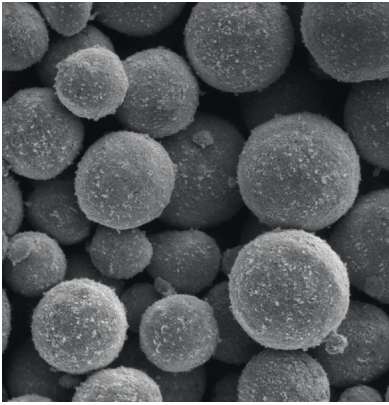

### Carbide composition

Carbide is a blend of tungsten carbide, cobalt and natural additives.

- ▶ A high percentage of tungsten carbide and a small grain size increase the lifetime and the wear resistance of the bit.

The lifetime of the carbide is defined by two variables:

1. The concentration of tungsten carbide in the grain mixture defines the hardness of the carbide.
2. The grain size of the carbide defines the resistance of the cutting edges. The smaller the grain size, the harder the surface.

#### Recycled carbide

= Poor lifetime

#### Standard carbide

= Good lifetime

#### High durable carbide

- ▶ Higher percentage of carbon in the blend
- = Long lifetime

#### Fine grade high durable carbide

- ▶ High percentage of carbon in the blend and small grain size = Exceptional lifetime

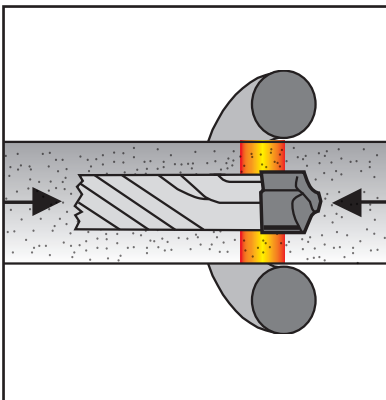

### Bonding process (flute and carbide)

Depending on the brazing material and the process, the bond may not be able to withstand certain thermal loads and may lose its stability. The drill bit can heat up to over 400 °C when drilling in natural stone or rebar.

- ▶ The bonding process therefore affects the lifetime of the drill bit (attachment of the drilling head).

There are 5 common bonding processes:

#### Belt oven brazing and hardening

- ▶ Brazing and heat treatment in one process. Finding the optimum temperature for simultaneous brazing and hardening is a compromise at the expense of the product.

#### Induction brazing

- ▶ Standard brazing operation to connect carbide tip with the flute.

#### Vacuum brazing and hardening

- ▶ Brazing in vacuum conditions, especially developed for large diameters. Brazing is performed in the first step followed by hardening to reduce thermal loads.

#### AWB brazing and hardening

- ▶ Diameter optimised brazing and hardening technology to increase the durability of the drill bit and simultaneously reduce the vibration during drilling.

#### Diffusion bonding

- ▶ Molecular bonding between the full head carbide and the flute of the drill bit. This technology provides the exceptionally strong bond to withstand the drilling force e.g. when you hit rebar.

# Effective dust transportation: the flute

The design of the flute is defined by a) the number of flutes, b) the core section of the drill bit and c) the size of the channels. It is important to find the right balance between an easy dust removal, optimum power transfer from the rotary hammer to the drill bit, and the optimum lifetime of the bit according to what you require.

## 2-flute L-shape (standard)

- ▶ Standard performance.

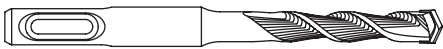

## 2-flute U-shape

- ▶ Highly efficient drilling dust removal in abrasive materials.

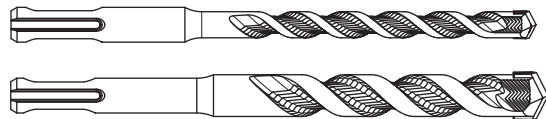

## 4-flute dura design

- ▶ Reinforced core section for high wear resistance and stability when drilling in concrete.



## 2-flute vario design

- ▶ Short, variable incline for easier drilling and less friction than U-shape flute in building materials.



## 4-flute turbo design

- ▶ Improved dust removal for smooth drilling in concrete. The stronger core section increases the lifetime of the drill bit.



## 2 + 2 flute design

- ▶ Vibration-optimised flute design for the best power transfer from the rotary hammer to the full carbide head. The incline of the flute ensures stability and can remove large metal chips when drilling through rebar.



# Quick mounting and 100% power transfer: the shank system

A mounting system is an important criteria for a professional drill bit. Bosch has and will continue to invent better solutions for the user.

**1975**

Bosch invented the SDS-plus system (shank size 10 mm) and revolutionised the way professionals can fix drill bits in small class hammers (< 5 kg).

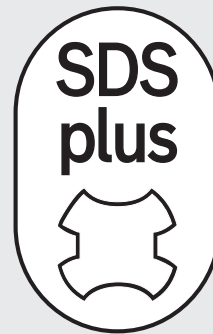

**1985**

Bosch invented the SDS-max system (shank size 18 mm) for large rotary hammers ( $\geq 5$  kg) to reap the same benefits of quick mounting and increased power transfer.



**2012**

Bosch launches the new Power Grip System for cylindrical shank drill bits. It enables 100% power transfer from the machine to the drill bit.

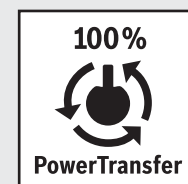
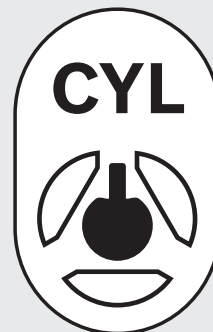

# Bosch offers the right solution – based on your needs and applications



## Increase in performance in new generation rotary hammers

The increase in performance, which is due to higher joules, provides a sustained boost in impact force and guarantees fast drilling speeds. A new generation of drill bits have been designed to meet the requirements of the new system to assure the rotary hammer can reach its full potential.

**It is therefore crucial to select the right drill bit.**

## SDS-plus-7: 3x lifetime and precise drilling even in rebar



### 5-cutter full head carbide

Shaped cutters for highest demolition force, exceptional lifetime and best wear resistance. No jamming in rebar



### activeQ

### activeteq

Active centring tip for active cutting in concrete (Pat. pending). Special cutting edge and angles to grind the concrete into fine dust

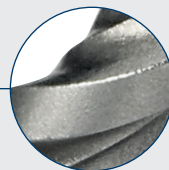

### 2 + 2 flute design

Vibration-optimised flute design for the best power transfer and speed



New rotary hammers are becoming more powerful, in order to achieve faster drilling speeds.

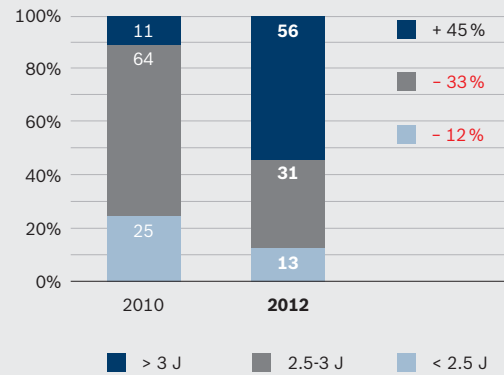

## SDS-plus-5: user-friendly drilling without stalling and stopping

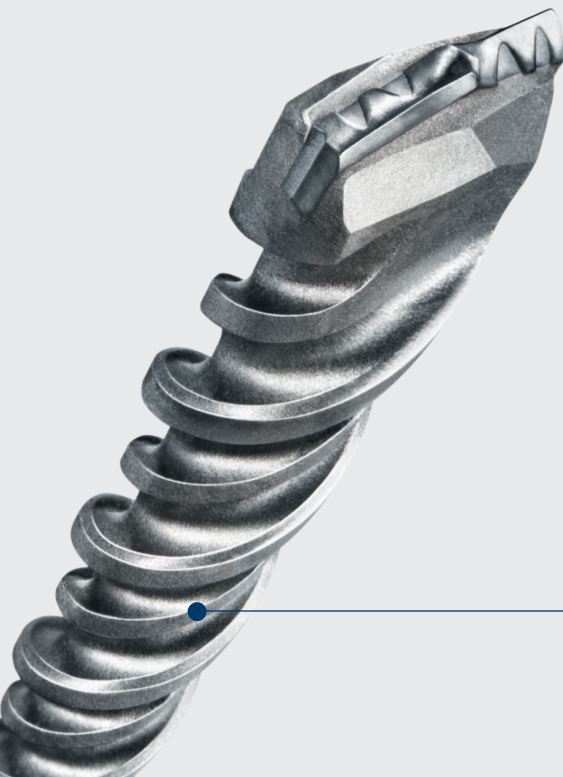

### Carbide relief grooves

Special V-shaped design for faster dust transportation into the flute in order to prevent clogging at the base of the drilled hole



### activeQ

### activeteq\*

Active centring tip for active cutting in concrete (Pat. pending). Special cutting edge and angles to grind the concrete into fine dust

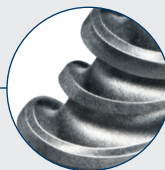

### 4-flute turbo design

Patented 4-flute design to efficiently remove dust

\* Diameter ≤ 10 mm

# Cylindrical shank

New product	CYL-1	CYL-3	CYL-5	CYL-9 MultiConstruction	CYL-9 Ceramic
Old product	Impact	Silver Percussion	Blue Granite	Multi Construction	Expert for Ceramic
					
Lifetime	●	●●●	●●●●	●●●	●●●
Speed	●●	●●●	●●●●●	●●●●●	●●●
Drilling dust removal	●●●	●●●	●●●●●	●●●●	●●●
Tip			activeteq	Centring tip	Centring tip
			Diamond-ground cutting edges	Diamond-ground cutting edges	Reinforced head
Cutters	2-cutter	2-cutter	2-cutter	2-cutter	2-cutter
Carbide		Long-life carbide	Long-life carbide with extremely fine grain	Long-life carbide with extremely fine grain	Long-life carbide
	Standard carbide				
Flute			2-flute vario design	4-flute dura design	
	2-flute U-shape	2-flute U-shape			



Optimum drilling



Long lifetime



Fast drilling



Multi Material



Tile drill bits

●/●● = good

●●●/●●●●● = better

●●●●● = best



# CYL-5

## 20% faster drilling

**activeteq**  
Active centring tip  
for active cutting in  
concrete



**2-cutter**  
Standard

**Fine grade high durable carbide**  
Extra-long life/  
Best wear resistance

**Diamond-ground cutting edges**  
Pulverises the concrete faster



The new Power Grip System enables 100% of the machine's power to be transferred to the drill bit

**2-flute vario design**  
Less friction and good dust removal for faster drilling

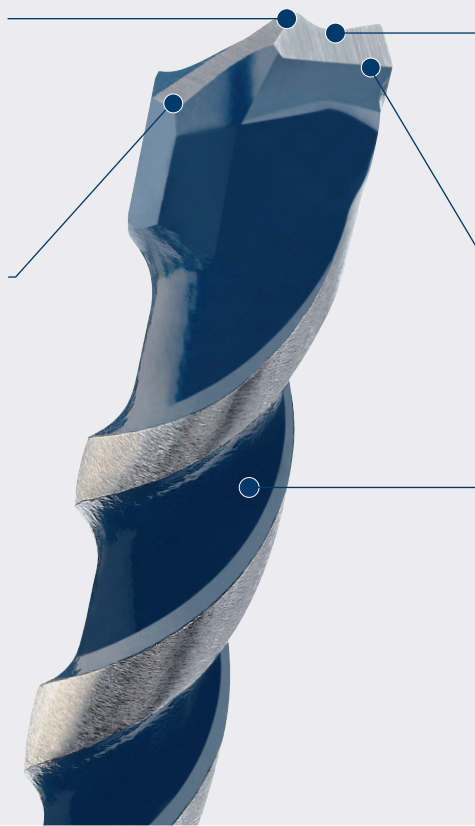

### CYL-5 concrete drill bits

# CYL-5

**BLUEGRANITE**



- ▶ **Suitable for** drilling holes in granite, concrete, masonry, limestone, natural and artificial stone
- ▶ Hammer resistant heavy duty drill bit, manufactured to ISO 5468, for all impact drills
- ▶ Suitable for drilling holes for fixings
- ▶ Drill bit colour: blue, polished

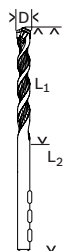

Product properties			Ordering information				
Diameter (D) mm	Working length (L1) mm	Total length (L2) mm	Part number	Packaging type	Pack quantity	Minimum order quantity	Barcode 3165140...
Pack of 1							
3.0	50	90	2 608 588 136	PC1d	1	5	690270
3.5	50	90	2 608 588 137	PC1d	1	5	690287
4.0	50	90	2 608 588 138	PC1d	1	5	690294
4.0	100	140	2 608 588 139	PC1d	1	5	690300
5.0	50	100	2 608 588 140	PC1d	1	5	690317
5.0	100	150	2 608 588 141	PC1d	1	5	690324

**CYL-5 concrete drill bits**

Product properties			Ordering information				
Diameter (D) mm	Working length (L1) mm	Total length (L2) mm	Part number	Packaging type	Pack quantity	Minimum order quantity	Barcode 3165140...
Pack of 1							
5.5	50	100	2 608 588 142	PC1d	1	5	690331
5.5	100	150	2 608 588 143	PC1d	1	5	690348
6.0	50	100	2 608 588 144	PC1d	1	5	690355
6.0	100	150	2 608 588 145	PC1d	1	5	690362
6.0	200	250	2 608 588 146	PC1d	1	5	690379
6.5	50	100	2 608 588 147	PC1d	1	5	690386
6.5	100	150	2 608 588 148	PC1d	1	5	690393
7.0	50	100	2 608 588 149	PC1d	1	5	690409
7.0	100	150	2 608 588 150	PC1d	1	5	690416
8.0	50	100	2 608 588 151	PC1d	1	5	690423
8.0	100	150	2 608 588 152	PC1d	1	5	690430
8.0	200	250	2 608 588 153	PC1d	1	1	690447
9.0	50	100	2 608 588 154	PC1d	1	5	691239
10.0	100	150	2 608 588 155	PC1d	1	5	690454
10.0	200	250	2 608 588 156	PC1d	1	1	690461
12.0	90	150	2 608 588 157	PC1d	1	5	690478
12.0	190	250	2 608 588 158	PC1d	1	1	690485
14.0	90	150	2 608 588 159	PC1d	1	1	690492
14.0	190	250	2 608 588 160	PC1d	1	1	690508
16.0	140	200	2 608 588 161	PC1d	1	1	690515
18.0	140	200	2 608 588 162	PC1d	1	1	690522
20.0	140	200	2 608 588 163	PC1d	1	1	690539

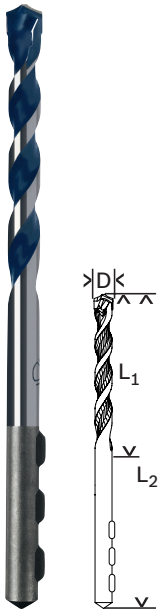

**CYL-5 concrete drill bit sets**

Product properties				Ordering information				
Diameter mm	Working length mm	Total length mm	Set size	Part number	Packaging type	Pack quantity	Minimum order quantity	Barcode 3165140...
3-piece CYL-5 concrete drill bit set								
5.0 6.0 8.0	50	100	A	2 608 588 164	P1k	3	5	690546



### CYL-5 concrete drill bit sets



Set size A:  
156.5 x 69.5 x 23 mm

Product properties			Ordering information						
Diameter mm	Working length mm	Total length mm	Set size	Part number	Packaging type	Pack quantity	Minimum order quantity	Barcode	3165140...
5-piece Robust Line CYL-5 concrete drill bit set									
4.0	50	90	A	2 608 588 165	P1k	5	1	690553	
5.0	50	100							
6.0	50	100							
6.0	50	100							
8.0	50	100							



Set size D:  
197.0 x 87.5 x 23 mm

7-piece Robust Line CYL-5 concrete drill bit set									
4.0	50	90	D	2 608 588 167	P1k	7	1	690577	
5.0	50	100							
5.0	50	100							
6.0	50	100							
6.0	50	100							
8.0	50	100							
10.0	100	150							

# CYL-3

## Long life drilling in concrete

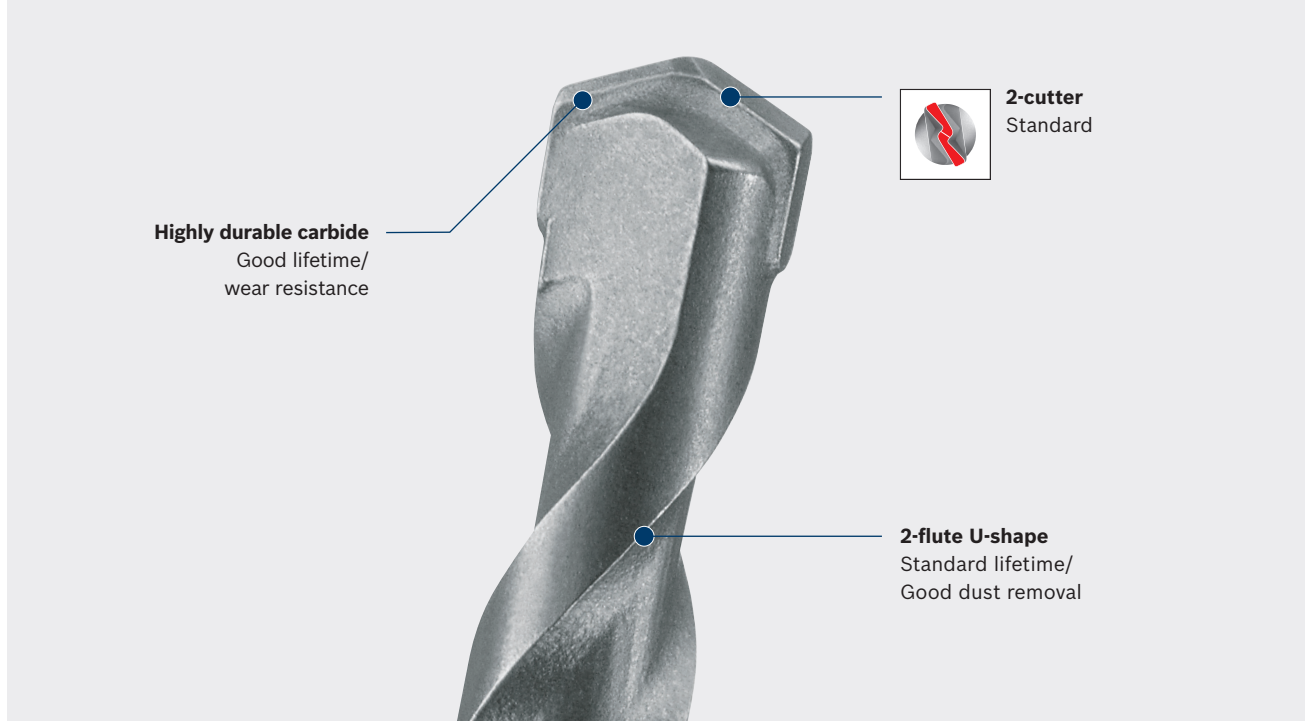

### CYL-3 concrete drill bits

## CYL-3

SILVER PERCUSSION



**long**  
LIFE

**fast**  
DRILL



- ▶ **Suitable for** drilling holes in concrete, masonry and limestone
- ▶ Hammer resistant heavy duty drill bit, manufactured to ISO 5468, for all impact drills
- ▶ Suitable for drilling holes for fixings
- ▶ Drill bit colour: silver-grey, sand-blasted



Diameter (D) mm	Working length (L1) mm	Total length (L2) mm	Part number	Packaging type	Pack quantity	Minimum order quantity	Barcode 3165140...
Product properties			Ordering information				

Pack of 1

3.0	40	70	2 608 597 655	PC1d	1	5	186674
3.5	40	70	2 608 585 225	PC1d	1	5	462266
4.0	40	75	2 608 597 656	PC1d	1	5	186681
4.5	40	75	2 608 597 657	PC1d	1	5	186698
5.0	50	85	2 608 597 658	PC1d	1	5	186704
5.0	90	150	2 608 597 677	PC1d	1	5	186896
5.5	50	85	2 608 597 659	PC1d	1	5	186711
5.5	90	150	2 608 597 678	PC1d	1	5	186902

**CYL-3 concrete drill bits**

Diameter (D) mm	Working length (L1) mm	Total length (L2) mm	Part number	Packaging type	Pack quantity	Minimum order quantity	Barcode 3165140...
-----------------	------------------------	----------------------	-------------	----------------	---------------	------------------------	--------------------

Product properties			Ordering information				
--------------------	--	--	----------------------	--	--	--	--

Pack of 1

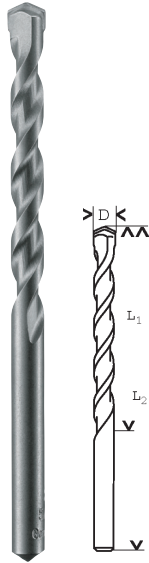

6.0	60	100	2 608 597 660	PC1d	1	5	186728
6.0	90	150	2 608 597 679	PC1d	1	5	186919
6.0	350	400	2 608 585 634	P1c	1	1	484428
6.5	60	100	2 608 597 661	PC1d	1	5	186735
6.5	90	150	2 608 597 680	PC1d	1	5	186926
6.5	350	400	2 608 597 689	P1c	1	1	187015
7.0	60	100	2 608 597 662	PC1d	1	5	186742
7.0	90	150	2 608 597 681	PC1d	1	5	186933
8.0	80	120	2 608 597 663	PC1d	1	5	186759
8.0	90	150	2 608 597 898	PC1d	1	5	212878
8.0	150	200	2 608 597 682	PC1d	1	5	186940
8.0	350	400	2 608 597 690	P1c	1	1	187022
9.0	80	120	2 608 597 664	PC1d	1	5	186766
10.0	80	120	2 608 597 665	PC1d	1	5	186773
10.0	90	150	2 608 597 899	PC1d	1	5	212885
10.0	150	200	2 608 597 683	PC1d	1	5	186957
10.0	250	300	2 608 597 685	P1c	1	1	186971
10.0	350	400	2 608 597 691	P1c	1	1	187039
10.0	550	600	2 608 597 698	P1c	1	1	187107
11.0	90	150	2 608 597 666	PC1d	1	5	186780
12.0	90	150	2 608 597 667	PC1d	1	5	186797
12.0	150	200	2 608 597 684	PC1d	1	5	186964
12.0	250	300	2 608 597 686	P1c	1	1	186988
12.0	350	400	2 608 597 692	P1c	1	1	187046
12.0	550	600	2 608 597 699	P1c	1	1	187114
13.0	90	150	2 608 597 668	PC1d	1	1	186803
13.0	250	300	2 608 597 687	P1c	1	1	186995
14.0	90	150	2 608 597 669	PC1d	1	1	186810
14.0	250	300	2 608 597 688	P1c	1	1	187008
14.0	350	400	2 608 597 693	P1c	1	1	187053
14.0	550	600	2 608 597 700	P1c	1	1	187121
15.0	100	160	2 608 597 670	P1c	1	1	186827
16.0	100	160	2 608 597 671	P1c	1	1	186834
16.0	350	400	2 608 597 694	P1c	1	1	187060
16.0	550	600	2 608 597 701	P1c	1	1	187138
18.0	100	160	2 608 597 672	P1c	1	1	186841
18.0	350	400	2 608 597 695	P1c	1	1	187077
18.0	550	600	2 608 597 702	P1c	1	1	187145
20.0	100	160	2 608 597 673	P1c	1	1	186858
20.0	350	400	2 608 597 696	P1c	1	1	187084
20.0	550	600	2 608 597 703	P1c	1	1	187152
22.0	100	160	2 608 597 674	P1c	1	1	186865
22.0	350	400	2 608 597 697	P1c	1	1	187091
25.0	100	160	2 608 597 675	P1c	1	1	186872



**CYL-3 concrete drill bits**

Diameter (D) mm	Working length (L1) mm	Total length (L2) mm	Part number	Packaging type	Pack quantity	Minimum order quantity	Barcode 3163140...
-----------------	------------------------	----------------------	-------------	----------------	---------------	------------------------	--------------------

Product properties			Ordering information				
--------------------	--	--	----------------------	--	--	--	--

Pack of 3

4.0	40	75	2 608 597 704	P1c	3	1	187169
5.0	50	85	2 608 597 705	P1c	3	1	187176
6.0	60	100	2 608 597 706	P1c	3	1	187183
6.5	60	100	2 608 597 707	P1c	3	1	187190
7.0	60	100	2 608 597 708	P1c	3	1	187206

Pack of 10

4.0	40	75	2 608 597 713	Cof	10	1	187251
4.5	40	75	2 608 597 714	Cof	10	1	187268
5.0	50	85	2 608 597 715	Cof	10	1	187275
6.0	60	100	2 608 597 716	Cof	10	1	187282
6.5	60	100	2 608 597 717	Cof	10	1	187299
7.0	60	100	2 608 597 718	Cof	10	1	187305
8.0	80	120	2 608 597 719	Cof	10	1	187312
10.0	80	120	2 608 597 720	Cof	10	1	187329
12.0	90	150	2 608 597 721	Cof	10	1	187336



**CYL-3 concrete drill bit sets**

Diameter mm	Working length mm	Total length mm	Part number	Packaging type	Pack quantity	Minimum order quantity	Barcode 3163140...
-------------	-------------------	-----------------	-------------	----------------	---------------	------------------------	--------------------

Product properties			Ordering information				
--------------------	--	--	----------------------	--	--	--	--

3-piece CYL-3 concrete drill bit set

5.0	50	85	2 608 597 709	Cof	3	5	187213
6.0	60	100					
8.0	80	120					



**CYL-3 concrete drill bit sets**

Diameter mm	Working length mm	Total length mm	Part number	Packaging type	Pack quantity	Minimum order quantity	Barcode 3165140...
-------------	-------------------	-----------------	-------------	----------------	---------------	------------------------	-----------------------



5-piece CYL-3 concrete drill bit set

Product properties			Ordering information				
4.0	40	75	<b>2 607 017 080</b>	P1k	5	4	601344
5.0	50	85					
6.0	60	100					
6.0	60	100					
8.0	80	120					
5.0	50	85	<b>2 607 017 081</b>	P1k	5	4	601351
5.5	50	85					
6.0	60	100					
7.0	60	100					
8.0	80	120					

7-piece CYL-3 concrete drill bit set



4.0	40	75	<b>2 607 017 082</b>	P1k	7	4	601368
5.0	50	85					
6.0	60	100					
6.0	60	100					
7.0	60	100					
8.0	80	120					
10.0	80	120					
4.0	40	75	<b>2 607 017 083</b>	P1k	7	4	601375
5.0	50	85					
5.5	50	85					
6.0	60	100					
7.0	60	100					
8.0	80	120					
8.0	80	120					
10.0	80	120					



# CYL-1

Optimised drilling

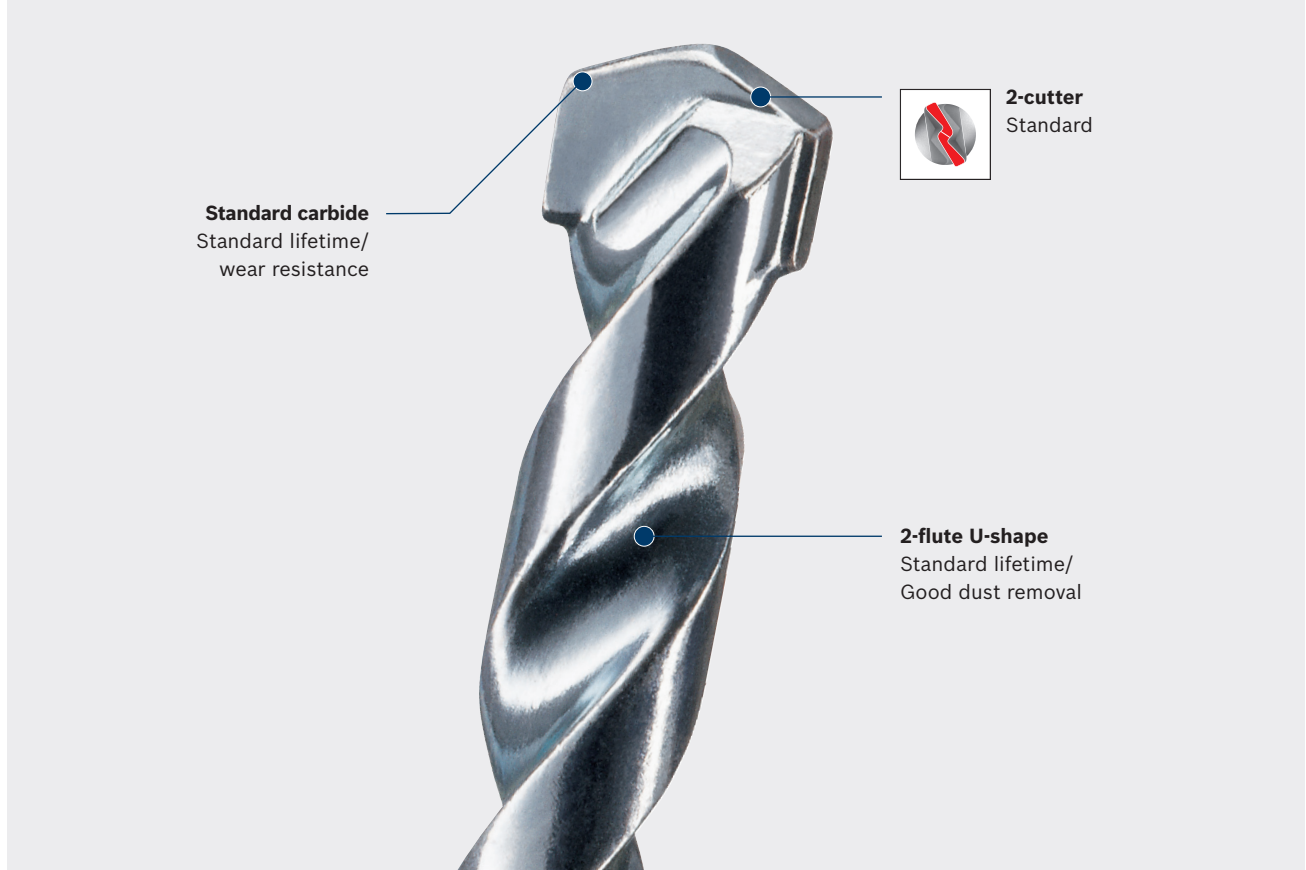

**Standard carbide**  
Standard lifetime/  
wear resistance

**2-cutter**  
Standard

**2-flute U-shape**  
Standard lifetime/  
Good dust removal

## CYL-1 masonry drill bits

### CYL-1 IMPACT



- ▶ **Suitable for** drilling holes in masonry and limestone
- ▶ Can be used with all impact drills
- ▶ Carbide tipped impact drill bit, manufactured to ISO 5468
- ▶ Drill bit colour: silver-grey

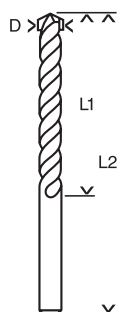

Diameter (D) mm	Working length (L1) mm	Total length (L2) mm	Part number	Packaging type	Pack quantity	Minimum order quantity	Barcode 3165140...
<b>Product properties</b>			<b>Ordering information</b>				
3.0	30	60	<b>2 608 596 125</b>	PC1d	1	5	045599
3.5	40	75	<b>2 608 596 126</b>	PC1d	1	5	045605
4.0	40	75	<b>1 609 200 205</b>	PC1d	1	5	004268
4.5	50	85	<b>2 608 596 127</b>	PC1d	1	5	045612
5.0	50	85	<b>1 609 200 206</b>	PC1d	1	5	004275
5.0	90	150	<b>2 608 596 128</b>	PC1d	1	5	045629
5.5	50	85	<b>2 608 596 129</b>	PC1d	1	5	045636
5.5	90	150	<b>2 608 596 130</b>	PC1d	1	5	045643



**CYL-1 masonry drill bits**

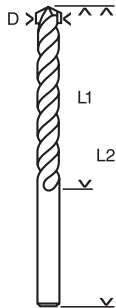

Product properties			Ordering information				
Diameter (D) mm	Working length (L1) mm	Total length (L2) mm	Part number	Packaging type	Pack quantity	Minimum order quantity	Barcode 3165140...
6.0	60	100	<b>1 609 200 207</b>	PC1d	1	5	004282
6.0	90	150	<b>2 608 596 357</b>	PC1d	1	5	059633
6.0	150	200	<b>2 608 596 143</b>	PC1d	1	5	045773
6.0	250	300	<b>2 608 596 358</b>	P1c	1	1	059640
6.0	350	400	<b>2 608 586 276</b>	P1c	1	1	529112
6.5	60	100	<b>2 608 596 131</b>	PC1d	1	5	045650
6.5	90	150	<b>2 608 596 359</b>	PC1d	1	5	059657
6.5	350	400	<b>2 608 596 361</b>	P1c	1	1	059671
7.0	60	100	<b>2 608 596 132</b>	PC1d	1	5	045667
7.0	90	150	<b>2 608 596 362</b>	PC1d	1	5	059688
7.0	350	400	<b>2 608 596 364</b>	P1c	1	1	059701
8.0	80	120	<b>1 609 200 209</b>	PC1d	1	5	004299
8.0	90	150	<b>2 608 596 365</b>	PC1d	1	5	059718
8.0	150	200	<b>2 608 596 145</b>	PC1d	1	5	045797
8.0	250	300	<b>2 608 596 366</b>	P1c	1	1	059725
8.0	350	400	<b>2 608 596 151</b>	P1c	1	1	046053
9.0	80	120	<b>2 608 596 134</b>	PC1d	1	5	045681
10.0	80	120	<b>1 609 200 210</b>	PC1d	1	5	004305
10.0	90	150	<b>2 608 596 368</b>	PC1d	1	5	059749
10.0	150	200	<b>2 608 596 148</b>	PC1d	1	5	046022
10.0	250	300	<b>2 608 596 369</b>	P1c	1	1	059756
10.0	350	400	<b>1 609 200 212</b>	P1c	1	1	004312
11.0	90	150	<b>2 608 596 135</b>	PC1d	1	5	045698
12.0	90	150	<b>2 608 596 136</b>	PC1d	1	5	045704
12.0	150	200	<b>2 608 596 149</b>	PC1d	1	5	046039
12.0	250	300	<b>2 608 597 041</b>	P1c	1	1	078825
12.0	350	400	<b>1 609 200 213</b>	P1c	1	1	004329
13.0	90	150	<b>2 608 596 137</b>	PC1d	1	1	045711
13.0	350	400	<b>2 608 597 043</b>	P1c	1	1	078849
14.0	90	150	<b>2 608 596 138</b>	PC1d	1	1	045728
14.0	150	200	<b>2 608 596 150</b>	PC1d	1	1	046046
14.0	250	300	<b>2 608 597 044</b>	P1c	1	1	078856
14.0	350	400	<b>2 608 596 152</b>	P1c	1	1	046060
15.0	90	150	<b>2 608 596 139</b>	P1c	1	1	045735
15.0	350	400	<b>2 608 597 047</b>	P1c	1	1	078887
16.0	90	150	<b>2 608 596 140</b>	P1c	1	1	045742
16.0	250	300	<b>2 608 597 048</b>	P1c	1	1	078894
16.0	350	400	<b>2 608 597 049</b>	P1c	1	1	078900
18.0	100	160	<b>2 608 596 141</b>	P1c	1	1	045759
18.0	250	300	<b>2 608 597 051</b>	P1c	1	1	078924
18.0	350	400	<b>2 608 597 052</b>	P1c	1	1	078931
20.0	100	160	<b>2 608 596 142</b>	P1c	1	1	045766
20.0	250	300	<b>2 608 597 054</b>	P1c	1	1	078955
20.0	350	400	<b>2 608 597 055</b>	P1c	1	1	078962

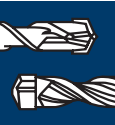

**CYL-1 masonry drill bit sets**



Product properties			Ordering information				
Diameter mm	Working length mm	Total length mm	Part number	Packaging type	Pack quantity	Minimum order quantity	Barcode 3165140...
<b>3-piece CYL-1 masonry drill bit set</b>							
5.0	50	85	1 609 200 204	P1h	3	5	004251
6.0	60	100					
8.0	80	120					



<b>7-piece CYL-1 masonry drill bit set</b>							
3.0	30	60	2 607 017 079	P1k	7	4	601337
4.0	40	75					
5.0	50	85					
6.0	60	100					
6.0	60	100					
7.0	60	100					
8.0	80	120					
3.0	30	60	2 607 017 035	P1k	7	4	557368
4.0	40	75					
5.0	50	85					
5.5	50	85					
6.0	60	100					
7.0	60	100					
8.0	80	120					

**Set for working in metal, wood, stone**



Product properties			Ordering information				
Diameter, metal mm	Diameter, stone mm	Diameter, wood mm	Part number	Packaging type	Pack quantity	Minimum order quantity	Barcode 3165140...
<b>13-piece metal, wood, masonry bit set</b>							
2.0	4.0	4.0	2 607 018 367	P1k	13	1	061230
2.5	5.0	5.0					
3.0	6.0	6.0					
4.0	8.0						
5.0							
6.0							



<b>15-piece mixed drill bit set</b>							
3.0	3.0	3.0	2 607 017 038	P1k	15	1	557399
4.0	4.0	4.0					
5.0	5.0	5.0					
6.0	6.0	6.0					
8.0	8.0	8.0					

# CYL-9 MultiConstruction

## Drilling in all kinds of materials

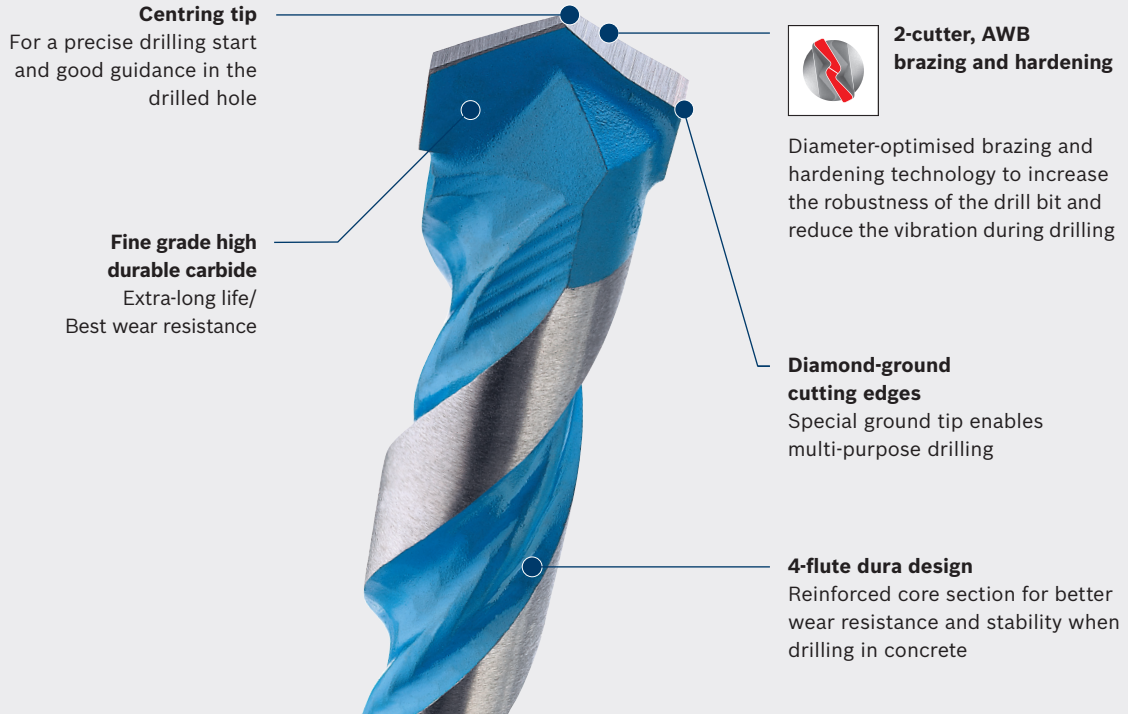

**Centring tip**  
For a precise drilling start and good guidance in the drilled hole

**Fine grade high durable carbide**  
Extra-long life/  
Best wear resistance



**2-cutter, AWB brazing and hardening**

Diameter-optimised brazing and hardening technology to increase the robustness of the drill bit and reduce the vibration during drilling

**Diamond-ground cutting edges**  
Special ground tip enables multi-purpose drilling

**4-flute dura design**  
Reinforced core section for better wear resistance and stability when drilling in concrete

### CYL-9 Multi Construction multi-purpose drill bits

**CYL-9 MultiConstruction**

**MULTI CONSTRUCTION**

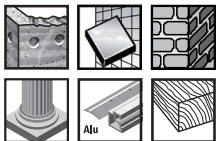

- ▶ **Suitable for** practically all materials in interior fitting work, e.g. concrete, masonry, brick, eternit, light building materials, multi-layer materials, ceramics and tiles, wood, plastic, sheet metals, aluminium
- ▶ Perfect results when drilling with or without impact
- ▶ Drill bit colour: blue, polished

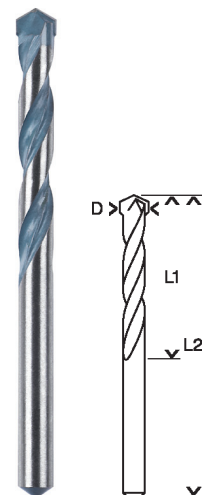

Product properties			Ordering information				
Diameter (D) mm	Working length (L1) mm	Total length (L2) mm	Part number	Packaging type	Pack quantity	Minimum order quantity	Barcode 3165140...
Pack of 1							
3.0	40	70	2 608 595 359	PC1d	1	5	328753
3.0	80	130	2 608 588 196	PC1d	1	5	693158
3.5	40	70	2 608 588 197	PC1d	1	5	693165
3.5	80	130	2 608 588 198	PC1d	1	5	693172
4.0	40	75	2 608 596 050	PC1d	1	5	044790
4.0	80	130	2 608 588 199	PC1d	1	5	693189
5.0	50	85	2 608 596 051	PC1d	1	5	044806
5.0	90	150	2 608 588 200	PC1d	1	5	693196

### CYL-9 Multi Construction multi-purpose drill bits

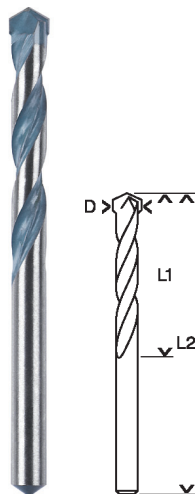

Diameter (D) mm	Working length (L1) mm	Total length (L2) mm	Part number	Packaging type	Pack quantity	Minimum order quantity	Barcode 3165140...
-----------------	------------------------	----------------------	-------------	----------------	---------------	------------------------	--------------------

**Product properties** | **Ordering information**

Pack of 1

5.5	50	85	2 608 596 052	PC1d	1	5	044813
5.5	100	150	2 608 588 201	PC1d	1	5	693202
6.0	60	100	2 608 596 053	PC1d	1	5	044820
6.0	90	150	2 608 596 060	PC1d	1	5	044899
6.0	200	250	2 608 595 506	PC1d	1	1	366465
6.0	350	400	2 608 588 202	P1c	1	1	693219
6.5	60	100	2 608 596 059	PC1d	1	5	044837
6.5	90	150	2 608 596 061	PC1d	1	5	044905
6.5	200	250	2 608 595 507	PC1d	1	1	366472
7.0	60	100	2 608 596 054	PC1d	1	5	044844
7.0	90	150	2 608 596 076	PC1d	1	5	046978
7.0	200	250	2 608 595 508	PC1d	1	1	366489
8.0	80	120	2 608 596 055	PC1d	1	5	044851
8.0	90	150	2 608 585 223	PC1d	1	5	462242
8.0	200	250	2 608 596 062	PC1d	1	1	044912
8.0	350	400	2 608 595 361	P1c	1	1	328777
9.0	80	120	2 608 596 056	PC1d	1	5	044868
10.0	80	120	2 608 596 057	PC1d	1	5	044875
10.0	90	150	2 608 585 224	PC1d	1	5	462259
10.0	200	250	2 608 596 063	PC1d	1	1	044929
10.0	350	400	2 608 588 203	P1c	1	1	693226
11.0	90	150	2 608 595 360	PC1d	1	5	328760
12.0	90	150	2 608 596 058	PC1d	1	5	044882
12.0	200	250	2 608 596 064	PC1d	1	1	044936
12.0	350	400	2 608 588 204	P1c	1	1	693233
14.0	150	200	2 608 588 205	PC1d	1	1	693240
14.0	200	250	2 608 596 065	PC1d	1	1	044943
14.0	350	400	2 608 588 206	P1c	1	1	693257
16.0	150	200	2 608 588 207	P1c	1	1	693264
16.0	350	400	2 608 588 208	P1c	1	1	693271
18.0	150	200	2 608 588 209	P1c	1	1	693288
18.0	350	400	2 608 588 210	P1c	1	1	693295
20.0	150	200	2 608 588 211	P1c	1	1	693301
20.0	350	400	2 608 588 212	P1c	1	1	693318

Pack of 10

4.0	40	75	2 608 587 146	P1a	10	1	587594
5.0	50	85	2 608 587 147	P1a	10	1	587600
5.5	50	85	2 608 587 148	P1a	10	1	587617
6.0	60	100	2 608 587 149	P1a	10	1	587624
6.5	60	100	2 608 587 150	P1a	10	1	587631
7.0	60	100	2 608 587 151	P1a	10	1	587648
8.0	80	120	2 608 587 152	P1a	10	1	587655



Pack of 8

10.0	80	120	2 608 587 153	P1a	8	1	587662
------	----	-----	---------------	-----	---	---	--------

### CYL-9 Multi Construction multi-purpose drill bit sets



Set size A:  
156.5 x 69.5 x 23 mm

Diameter mm	Working length mm	Total length mm	Set size	Part number	Packaging type	Pack quantity	Minimum order quantity	Barcode
-------------	-------------------	-----------------	----------	-------------	----------------	---------------	------------------------	---------

Product properties			Ordering information					
4-piece Robust Line CYL-9 Multi Construction multi-purpose drill bit set								
4.0	40	75	A	2 607 010 521	P1k	4	1	446051
5.0	50	85						
6.0	60	100						
8.0	80	120						
5.5	50	85	A	2 607 010 522	P1k	4	1	446068
6.0	60	100						
7.0	60	100						
8.0	80	120						



Set size D:  
197.0 x 87.5 x 23 mm

7-piece Robust Line CYL-9 Multi Construction multi-purpose drill bit set								
4.0	40	75	D	2 607 010 543	P1k	7	1	446273
5.0	50	85						
6.0	60	100						
6.0	60	100						
8.0	80	120						
10.0	80	120						
12.0	90	150						
5.0	50	85	D	2 607 010 546	P1k	7	1	446303
5.5	50	85						
6.0	60	100						
6.0	60	150						
7.0	60	150						
8.0	80	150						
10.0	80	150						

# CYL-9 Ceramic

## Drilling in soft and medium density tiles

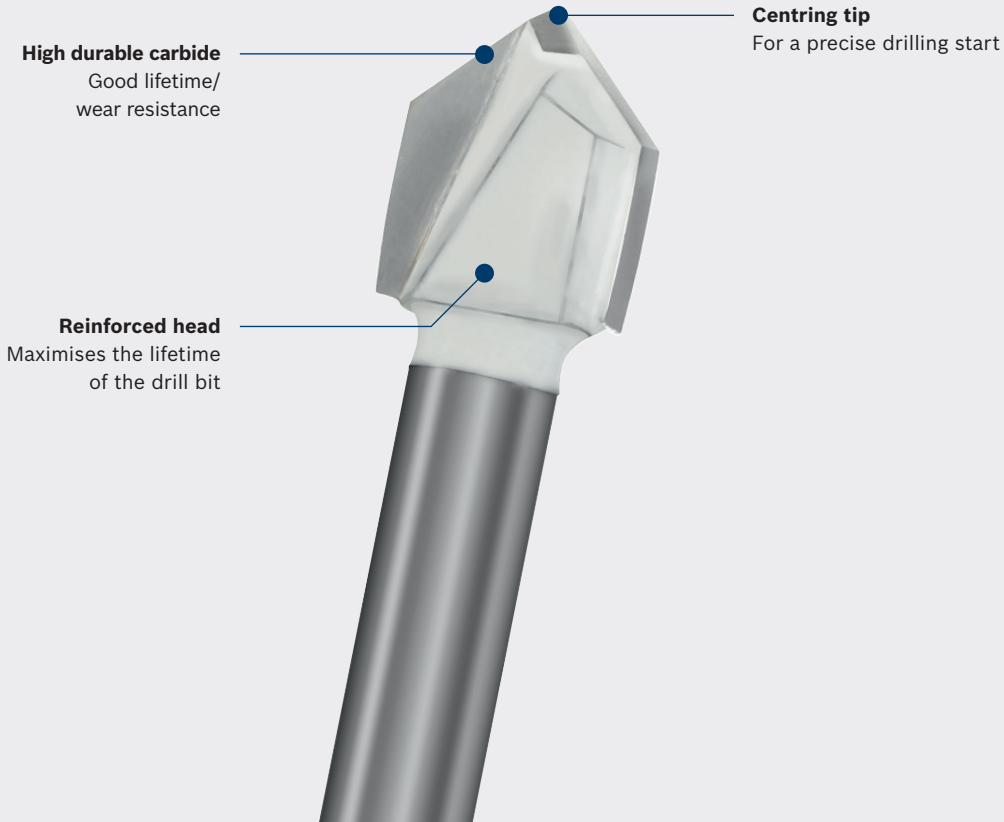

### CYL-9 Ceramic tile drill bits

- CYL-9 Ceramic** ▶ **Suitable for** all soft to medium density tiles, porcelain, ceramics and non-toughened glass
- expert **Ceramic**
- ▶ Drill bit colour: white
  - ▶ **Note:** Use with low speeds and without impact. No cooling required



Diameter (D) mm	Total length (L2) mm	Part number	Packaging type	Pack quantity	Minimum order quantity	Barcode 3165140...
<b>3.0</b>	70	<b>2 608 587 157</b>	PC1a	1	5	599184
<b>4.0</b>	70	<b>2 608 587 158</b>	PC1a	1	5	599191
<b>5.0</b>	70	<b>2 608 587 159</b>	PC1a	1	5	599207
<b>5.5</b>	70	<b>2 608 587 160</b>	PC1a	1	5	599214
<b>6.0</b>	80	<b>2 608 587 161</b>	PC1a	1	5	599221
<b>6.5</b>	80	<b>2 608 587 162</b>	PC1a	1	5	599238

### CYL-9 Ceramic tile drill bits

Product properties		Ordering information				
Diameter (D) mm	Total length (L2) mm	Part number	Packaging type	Pack quantity	Minimum order quantity	Barcode 3165140...
7.0	80	2 608 587 163	PC1a	1	5	599245
8.0	80	2 608 587 164	PC1a	1	5	599252
10.0	90	2 608 587 165	PC1a	1	5	599269
12.0	90	2 608 587 166	PC1a	1	5	599276
14.0	90	2 608 587 167	PC1a	1	5	599283
16.0	90	2 608 587 168	PC1a	1	5	599290





### 5-piece CYL-9 Ceramic tile drill bit sets



Product properties		Ordering information				
Diameter mm	Total length mm	Part number	Packaging type	Pack quantity	Minimum order quantity	Barcode 3165140...
5-piece CYL-9 Ceramic tile drill bit set						
4.0	70	2 608 587 169	P1k	5	1	599306
5.0	70					
6.0	80					
8.0	80					
10.0	90					
5.5	70	2 608 587 170	P1k	5	1	599863
6.0	80					
7.0	80					
8.0	80					
10.0	90					

# SDS-plus shank



New product	SDS-plus-5	SDS-plus-7	SDS-plus-9 RebarCutter	SDS-plus-9 CoreCutter
Old product	S4L	X5L & Speed X		
				
Lifetime	●●●	●●●●●	●●	●●●●
Speed	●●●●	●●●●●	●●●	●●●●●
Drilling dust removal	●●●●	●●●●●	●●	●●
Tip	activeteq	activeteq		
	Wear indicator	Wear indicator	Ventilation hole	
	Carbide relief grooves			
Cutters	AWB brazing and hardening	5-cutter solid carbide head, diffusion bonding technology	Carbide teeth	Asymmetric carbide teeth
	2-cutter			
Carbide	Long-life carbide	Long-life carbide with extremely fine grain	Long-life carbide	Long-life carbide with extremely fine grain
Flute	4-flute turbo design	2 + 2 flute design	2 + 2 flute design	
			Unique flute design	



User-friendly drilling



3 times longer lifetime and higher precision



Rebar



For switch boxes

●/●● = good

●●●/●●●● = better

●●●●● = best



# SDS-plus-7

3x lifetime and precise drilling even in rebar

**activeteq**  
Active centring tip for active cutting in concrete

**activeteQ**

**5-cutter full head carbide, diffusion bonding technology**  
Shaped cutters for highest demolition force, exceptional lifetime and best wear resistance. No jamming in rebar

**Fine grade high durable carbide**  
Long lifetime/  
Best wear resistance

**Wear mark**  
The visibility of the wear mark indicates if the diameter of the hole is still in tolerance for metal anchor setting

**2 + 2 flute design**  
Vibration-optimised flute design for the best power transfer and speed

## SDS-plus-7 hammer drill bits

- SDS-plus-7** ▶ Suitable for masonry, concrete and reinforced concrete
- ▶ Appropriate for all rotary hammers with SDS-plus holder

**X5L**

Speed **X**

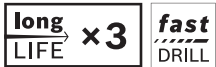

Product properties			Ordering information				
Diameter (D) mm	Working length (L1) mm	Total length (L2) mm	Part number	Packaging type	Pack quantity	Minimum order quantity	Barcode 3165140...
Pack of 1							
5.0	50	110	2 608 585 023	P1e	1	1	439909
5.0	100	160	2 608 585 024	P1e	1	1	439916
5.0	150	210	2 608 585 025	P1e	1	1	439923
5.5	50	110	2 608 585 026	P1e	1	1	439930
5.5	100	160	2 608 585 027	P1e	1	1	439947
6.0	50	115	2 608 585 028	P1e	1	1	439954
6.0	100	165	2 608 585 029	P1e	1	1	439961
6.0	150	215	2 608 585 030	P1e	1	1	439978
6.0	200	265	2 608 585 031	P1e	1	1	439985

SDS-plus-7 hammer drill bits

Diameter (D) mm	Working length (L1) mm	Total length (L2) mm	Part number	Packaging type	Pack quantity	Minimum order quantity	Barcode 3165140...
-----------------	------------------------	----------------------	-------------	----------------	---------------	------------------------	--------------------

Product properties			Ordering information				
--------------------	--	--	----------------------	--	--	--	--

Pack of 1

6.5	50	115	2 608 585 032	P1e	1	1	439992
6.5	100	165	2 608 585 033	P1e	1	1	440004
6.5	200	265	2 608 585 035	P1e	1	1	440028
6.5	250	315	2 608 587 171	P1e	1	1	604895
7.0	50	115	2 608 585 036	P1e	1	1	440035
7.0	100	165	2 608 585 037	P1e	1	1	440042
7.0	150	215	2 608 585 943	P1e	1	1	522175
8.0	50	115	2 608 585 038	P1e	1	1	440059
8.0	100	165	2 608 585 039	P1e	1	1	440066
8.0	150	215	2 608 585 040	P1e	1	1	440073
8.0	200	265	2 608 585 041	P1e	1	1	440080
8.0	250	315	2 608 587 172	P1e	1	1	604901
8.0	300	365	2 608 585 042	P1e	1	1	440097
8.0	400	465	2 608 585 043	P1e	1	1	440103
10.0	50	115	2 608 585 044	P1e	1	1	440110
10.0	100	165	2 608 585 045	P1e	1	1	440127
10.0	150	215	2 608 585 046	P1e	1	1	440134
10.0	200	265	2 608 585 047	P1e	1	1	440141
10.0	250	315	2 608 587 173	P1e	1	1	604918
10.0	300	365	2 608 585 048	P1e	1	1	440158
10.0	400	465	2 608 585 049	P1e	1	1	440165
12.0	100	165	2 608 585 050	P1e	1	1	440172
12.0	150	215	2 608 585 051	P1e	1	1	440189
12.0	200	265	2 608 585 052	P1e	1	1	440196
12.0	300	365	2 608 585 053	P1e	1	1	440202
12.0	400	465	2 608 585 054	P1e	1	1	440219
14.0	100	165	2 608 585 944	P1e	1	1	522182
14.0	150	215	2 608 585 945	P1e	1	1	522199
14.0	200	265	2 608 585 946	P1e	1	1	522205
14.0	300	365	2 608 585 947	P1e	1	1	522212
14.0	400	465	2 608 585 948	P1e	1	1	522229
15.0	100	165	2 608 587 178	P1e	1	1	605601
15.0	200	265	2 608 587 179	P1e	1	1	605618
16.0	150	215	2 608 587 180	P1e	1	1	605625
16.0	200	265	2 608 587 181	P1e	1	1	605632
16.0	400	465	2 608 587 182	P1e	1	1	605649
18.0	200	250	2 608 586 719	P1e	1	1	564434
18.0	400	450	2 608 586 720	P1e	1	1	564441
20.0	200	250	2 608 586 721	P1e	1	1	564458
20.0	400	450	2 608 586 722	P1e	1	1	564465
22.0	200	250	2 608 586 723	P1e	1	1	564472
22.0	400	450	2 608 586 724	P1e	1	1	564489
24.0	400	450	2 608 586 725	P1e	1	1	564496
25.0	400	450	2 608 586 726	P1e	1	1	564502
28.0	400	450	2 608 586 727	P1e	1	1	564519
30.0	400	450	2 608 586 728	P1e	1	1	564526



**SDS-plus-7 hammer drill bits**

Diameter (D) mm	Working length (L1) mm	Total length (L2) mm	Part number	Packaging type	Pack quantity	Minimum order quantity	Barcode 3165140...
-----------------	------------------------	----------------------	-------------	----------------	---------------	------------------------	--------------------

Product properties			Ordering information				
--------------------	--	--	----------------------	--	--	--	--

Pack of 10

5.0	50	110	2 608 585 055	P1a	10	1	440226
5.0	100	160	2 608 585 056	P1a	10	1	440233
5.5	100	160	2 608 585 057	P1a	10	1	440240
6.0	50	115	2 608 585 058	P1a	10	1	440257
6.0	100	165	2 608 585 059	P1a	10	1	440264
6.0	150	215	2 608 585 060	P1a	10	1	440271
6.5	100	165	2 608 585 061	P1a	10	1	440288
6.5	200	265	2 608 585 949	P1a	10	1	522236
6.5	250	315	2 608 587 174	P1a	10	1	604925
7.0	100	165	2 608 585 950	P1a	10	1	522243
7.0	150	215	2 608 585 951	P1a	10	1	522250
8.0	50	115	2 608 585 062	P1a	10	1	440295
8.0	100	165	2 608 585 063	P1a	10	1	440301
8.0	150	215	2 608 585 064	P1a	10	1	440318
8.0	200	265	2 608 587 175	P1a	10	1	604932
8.0	250	315	2 608 587 176	P1a	10	1	604949
10.0	100	165	2 608 585 065	P1a	10	1	440325
10.0	150	215	2 608 585 066	P1a	10	1	440332
10.0	200	265	2 608 585 067	P1a	10	1	440349
10.0	250	315	2 608 587 177	P1a	10	1	604956
12.0	100	165	2 608 585 068	P1a	10	1	440356
12.0	150	215	2 608 585 069	P1a	10	1	440363



Pack of 30

5.0	50	110	2 608 586 455	P0a	30	1	553773
5.0	100	160	2 608 586 456	P0a	30	1	553780
6.0	50	115	2 608 586 457	P0a	30	1	553797
6.0	100	165	2 608 586 458	P0a	30	1	553803
8.0	100	165	2 608 586 459	P0a	30	1	553810
8.0	150	215	2 608 586 460	P0a	30	1	553827
10.0	100	165	2 608 586 461	P0a	30	1	553834
10.0	150	215	2 608 586 462	P0a	30	1	553841
10.0	200	265	2 608 586 463	P0a	30	1	553858



Pack of 25

12.0	100	165	2 608 586 464	P0a	25	1	553865
12.0	150	215	2 608 586 465	P0a	25	1	553872



### Robust Line SDS-plus-7 hammer drill bit sets



Set size D:  
197.0 x 87.5 x 23 mm

Product properties			Ordering information				
Diameter mm	Working length mm	Total length mm	Part number	Packaging type	Pack quantity	Minimum order quantity	Barcode 3165140...
5-piece Robust Line SDS-plus-7 hammer drill bit set							
5.0	50	110	<b>2 608 585 073</b>	P1k	5	1	440400
6.0	50	115					
6.0	100	165					
8.0	100	165					
10.0	100	165					
5.5	100	165	<b>2 607 019 933</b>	P1k	5	1	517133
6.0	100	165					
7.0	100	165					
8.0	100	165					
10.0	100	165					
6.0	100	165	<b>2 607 019 932</b>	P1k	5	1	517126
6.0	100	165					
8.0	100	165					
8.0	100	165					
10.0	100	165					

# SDS-plus-5

Smooth drilling without stalling and stopping

**activeteq\***  
Active centring tip for active cutting in concrete



**High durable carbide**  
Good lifetime/wear resistance

**Wear mark**



The visibility of the wear mark indicates if the hole diameter is still in tolerance for metal anchor setting

\* Diameter ≤ 10 mm

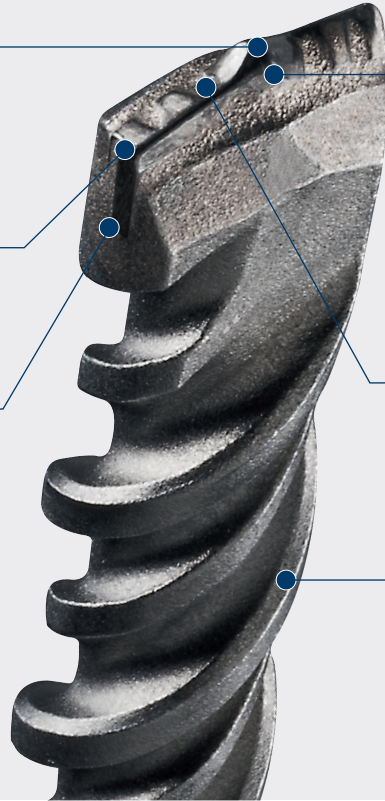

**2-cutter, AWB brazing and hardening**

Diameter-optimised brazing and hardening technology to increase the robustness of the drill bit and reduce the vibration during drilling

**Carbide relief grooves**

Special V-shaped design for faster dust transportation into the flute in order to prevent clogging at the base of the drilled hole

**4-flute turbo design**

Patented 4-flute design to efficiently remove dust

## SDS-plus-5 hammer drill bits

### SDS-plus-5 S4L

- ▶ Suitable for masonry, concrete
- ▶ Appropriate for all rotary hammers with SDS-plus holder

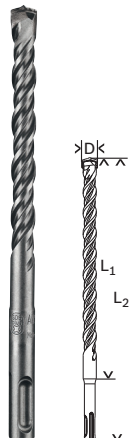
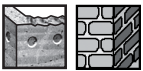

Diameter (D) mm	Working length (L1) mm	Total length (L2) mm	Part number	Packaging type	Pack quantity	Minimum order quantity	Barcode 3163140...
<b>Product properties</b>			<b>Ordering information</b>				
Pack of 1							
3.0	50	100	2 608 587 801	P1e	1	5	656436
3.0	100	160	2 608 587 802	P1e	1	5	656443
3.5	50	110	2 608 597 773	P1e	1	5	189057
3.5	100	160	2 608 585 596	P1e	1	5	483308
4.0	50	115	1 618 596 231	P1e	1	5	028073
4.0	100	165	2 608 597 774	P1e	1	5	189064

SDS-plus-5 hammer drill bits

Diameter (D) mm	Working length (L1) mm	Total length (L2) mm	Part number	Packaging type	Pack quantity	Minimum order quantity	Barcode 3165140...
-----------------	------------------------	----------------------	-------------	----------------	---------------	------------------------	--------------------

Product properties			Ordering information				
--------------------	--	--	----------------------	--	--	--	--

Pack of 1

5.0	50	115	1 618 596 164	P1e	1	5	027724
5.0	100	165	1 618 596 189	P1e	1	5	027977
5.0	150	215	2 608 596 199	P1e	1	5	074391
5.0	200	265	2 608 585 597	P1e	1	5	483315
5.0	250	315	2 608 585 598	P1e	1	5	483322
5.0	400	465	2 608 585 599	P1e	1	1	483339
5.5	50	115	1 618 596 165	P1e	1	5	027731
5.5	100	165	2 608 596 146	P1e	1	5	045957
5.5	150	215	2 608 597 775	P1e	1	5	189071
5.5	200	265	2 608 597 776	P1e	1	5	189088
5.5	250	315	2 608 585 600	P1e	1	5	483346
5.5	400	465	2 608 585 601	P1e	1	1	483353
6.0	50	115	1 618 596 166	P1e	1	5	027748
6.0	100	165	1 618 596 167	P1e	1	5	027755
6.0	150	215	2 608 596 115	P1e	1	5	045148
6.0	200	265	2 608 597 777	P1e	1	5	189095
6.0	250	315	2 608 585 602	P1e	1	5	483360
6.0	400	465	2 608 585 603	P1e	1	1	483377
6.5	50	115	1 618 596 168	P1e	1	5	027762
6.5	100	165	1 618 596 169	P1e	1	5	027779
6.5	150	215	2 608 597 778	P1e	1	5	189101
6.5	200	265	2 608 597 779	P1e	1	5	189118
6.5	250	315	2 608 597 780	P1e	1	5	189125
6.5	400	465	2 608 587 830	P1e	1	1	656726
7.0	50	115	1 618 596 170	P1e	1	5	027786
7.0	100	165	1 618 596 171	P1e	1	5	027793
7.0	150	215	2 608 597 130	P1e	1	5	098588
7.0	200	265	2 608 587 834	P1e	1	5	656764
7.0	250	315	2 608 587 835	P1e	1	5	656771
7.0	400	465	2 608 587 836	P1e	1	1	656788
8.0	50	115	1 618 596 172	P1e	1	5	027809
8.0	100	165	1 618 596 173	P1e	1	5	027816
8.0	150	215	1 618 596 174	P1e	1	5	027823
8.0	200	265	1 618 596 264	P1e	1	5	028332
8.0	250	315	2 608 597 944	P1e	1	5	260237
8.0	400	465	2 608 596 116	P1e	1	1	045155
8.0	550	615	2 608 596 183	P1e	1	1	047593
8.5	100	165	2 608 585 604	P1e	1	5	483384
8.5	150	215	2 608 585 605	P1e	1	5	483391
8.5	200	265	2 608 587 846	P1e	1	5	656887
9.0	100	165	2 608 596 158	P1e	1	5	046381
9.0	150	215	1 618 596 175	P1e	1	5	027830
9.0	200	265	2 608 587 849	P1e	1	5	656917
10.0	50	115	1 618 596 176	P1e	1	5	027847
10.0	100	165	1 618 596 177	P1e	1	5	027854
10.0	150	215	1 618 596 265	P1e	1	5	028349
10.0	200	265	1 618 596 178	P1e	1	5	027861
10.0	250	315	1 618 596 315	P1e	1	5	046305
10.0	400	465	1 618 596 267	P1e	1	1	028363
10.0	550	615	2 608 596 117	P1e	1	1	045162
10.0	950	1005	2 608 597 122	P1e	1	1	098502

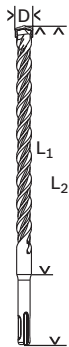

**SDS-plus-5 hammer drill bits**

Diameter (D) mm	Working length (L1) mm	Total length (L2) mm	Part number	Packaging type	Pack quantity	Minimum order quantity	Barcode 3165140...
-----------------	------------------------	----------------------	-------------	----------------	---------------	------------------------	--------------------

**Product properties** | **Ordering information**

Pack of 1

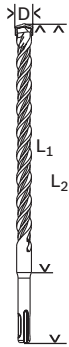

11.0	100	165	<b>1 618 596 179</b>	P1e	1	5	027878
11.0	150	215	<b>1 618 596 316</b>	P1e	1	5	046312
11.0	200	265	<b>1 618 596 180</b>	P1e	1	5	027885
12.0	100	165	<b>1 618 596 181</b>	P1e	1	5	027892
12.0	150	215	<b>1 618 596 268</b>	P1e	1	5	028370
12.0	200	265	<b>1 618 596 182</b>	P1e	1	5	027908
12.0	250	315	<b>2 608 597 782</b>	P1e	1	5	189149
12.0	400	465	<b>1 618 596 269</b>	P1e	1	1	028387
12.0	550	615	<b>1 618 596 224</b>	P1e	1	1	028035
12.0	950	1005	<b>2 608 597 123</b>	P1e	1	1	098519
13.0	100	165	<b>1 618 596 183</b>	P1e	1	5	027915
13.0	150	215	<b>1 618 596 318</b>	P1e	1	5	046329
13.0	200	265	<b>1 618 596 184</b>	P1e	1	5	027922
14.0	100	165	<b>1 618 596 185</b>	P1e	1	5	027939
14.0	150	215	<b>1 618 596 270</b>	P1e	1	5	028394
14.0	200	265	<b>1 618 596 186</b>	P1e	1	5	027946
14.0	250	315	<b>1 618 596 271</b>	P1e	1	5	028400
14.0	400	465	<b>2 608 596 118</b>	P1e	1	1	045179
14.0	550	615	<b>1 618 596 225</b>	P1e	1	1	028042
14.0	950	1005	<b>2 608 597 124</b>	P1e	1	1	098526
15.0	100	165	<b>1 618 596 187</b>	P1e	1	5	027953
15.0	200	265	<b>1 618 596 188</b>	P1e	1	5	027960
15.0	400	465	<b>1 618 596 257</b>	P1e	1	1	028264
16.0	150	215	<b>2 608 596 185</b>	P1e	1	5	047616
16.0	200	265	<b>2 608 585 607</b>	P1e	1	5	483414
16.0	250	315	<b>2 608 596 186</b>	P1e	1	5	047623
16.0	400	465	<b>1 618 596 259</b>	P1e	1	1	028288
16.0	550	615	<b>1 618 596 226</b>	P1e	1	1	028059
16.0	950	1005	<b>2 608 597 125</b>	P1e	1	1	098533
17.0	150	215	<b>1 618 596 203</b>	P1e	1	1	027991
17.0	250	315	<b>2 608 585 952</b>	P1e	1	1	522267
17.0	400	465	<b>2 608 585 953</b>	P1e	1	1	522410
18.0	150	200	<b>1 618 596 204</b>	P1e	1	5	028004
18.0	250	300	<b>1 618 596 319</b>	P1e	1	1	046336
18.0	400	450	<b>1 618 596 260</b>	P1e	1	1	028295
18.0	550	600	<b>2 608 596 120</b>	P1e	1	1	045193
18.0	950	1000	<b>2 608 597 126</b>	P1e	1	1	098540
19.0	150	200	<b>1 618 596 205</b>	P1e	1	1	028011
19.0	250	300	<b>1 618 596 320</b>	P1e	1	1	046343
19.0	400	450	<b>1 618 596 261</b>	P1e	1	1	028301
20.0	150	200	<b>1 618 596 207</b>	P1e	1	1	028028
20.0	250	300	<b>1 618 596 262</b>	P1e	1	1	028318
20.0	400	450	<b>1 618 596 263</b>	P1e	1	1	028325
20.0	550	600	<b>1 618 596 321</b>	P1e	1	1	046350
20.0	950	1000	<b>2 608 597 127</b>	P1e	1	1	098557
22.0	200	250	<b>1 618 596 232</b>	P1e	1	1	028080
22.0	400	450	<b>1 618 596 233</b>	P1e	1	1	028097
22.0	550	600	<b>2 608 596 123</b>	P1e	1	1	045223
22.0	950	1000	<b>2 608 597 128</b>	P1e	1	1	098564
24.0	200	250	<b>1 618 596 236</b>	P1e	1	1	028127
24.0	400	450	<b>1 618 596 237</b>	P1e	1	1	028134

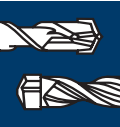

SDS-plus-5 hammer drill bits

Diameter (D) mm	Working length (L1) mm	Total length (L2) mm	Part number	Packaging type	Pack quantity	Minimum order quantity	Barcode 3165140...
-----------------	------------------------	----------------------	-------------	----------------	---------------	------------------------	-----------------------

Product properties			Ordering information				
--------------------	--	--	----------------------	--	--	--	--

Pack of 1

25.0	200	250	1 618 596 238	P1e	1	1	028141
25.0	400	450	1 618 596 239	P1e	1	1	028158
25.0	550	600	2 608 587 910	P1e	1	1	657525
25.0	950	1000	2 608 597 129	P1e	1	1	098571
26.0	200	250	1 618 596 240	P1e	1	1	028165
26.0	400	450	1 618 596 241	P1e	1	1	028172

Pack of 10

3.5	50	110	2 608 585 608	P1a	10	1	483421
3.5	100	160	2 608 585 609	P1a	10	1	483438
4.0	50	115	2 608 585 610	P1a	10	1	483445
4.0	100	165	2 608 585 611	P1a	10	1	483452
5.0	50	115	2 608 585 612	P1a	10	1	483469
5.0	100	165	2 608 585 613	P1a	10	1	483476
5.5	50	115	2 608 585 614	P1a	10	1	483483
5.5	100	165	2 608 585 615	P1a	10	1	483490
6.0	50	115	2 608 585 616	P1a	10	1	483506
6.0	100	165	2 608 585 617	P1a	10	1	483513
6.0	150	215	2 608 585 618	P1a	10	1	483520
6.5	100	165	2 608 585 619	P1a	10	1	483537
6.5	150	215	2 608 585 620	P1a	10	1	483544
6.5	200	265	2 608 585 621	P1a	10	1	483551
7.0	100	165	2 608 585 622	P1a	10	1	483568
7.0	150	215	2 608 587 929	P1a	10	1	657716
8.0	100	165	2 608 585 623	P1a	10	1	483575
8.0	150	215	2 608 585 624	P1a	10	1	483582
8.0	200	265	2 608 585 625	P1a	10	1	483599
10.0	100	165	2 608 585 626	P1a	10	1	483605
10.0	150	215	2 608 585 627	P1a	10	1	483612
10.0	200	265	2 608 585 628	P1a	10	1	483629
12.0	100	165	2 608 585 629	P1a	10	1	483636
12.0	150	215	2 608 585 630	P1a	10	1	483643
12.0	200	265	2 608 585 631	P1a	10	1	483650





**SDS-plus-5 hammer drill bit sets**



Diameter mm	Working length mm	Total length mm	Part number	Packaging type	Pack quantity	Minimum order quantity	Barcode 3165140...
-------------	-------------------	-----------------	-------------	----------------	---------------	------------------------	--------------------

Product properties			Ordering information				
--------------------	--	--	----------------------	--	--	--	--

3-piece SDS-plus-5 hammer drill bit set

5.0	50	110	<b>1 617 000 118</b>	P1c	3	5	011938
6.0	50	110					
8.0	100	160					
6.0	100	160	<b>1 617 000 117</b>	P1c	3	5	015721
8.0	100	160					
10.0	100	160					



5-piece Robust Line SDS-plus-5 hammer drill bit set

5.0	50	115	<b>2 607 019 927</b>	P1k	5	1	517072
6.0	50	115					
6.0	100	165					
8.0	100	165					
10.0	100	165					
5.5	100	165	<b>2 607 019 929</b>	P1k	5	1	517102
6.0	100	165					
7.0	100	165					
8.0	100	165					
10.0	100	165					
6.0	100	165	<b>2 607 019 928</b>	P1k	5	1	517089
6.0	100	165					
8.0	100	165					
8.0	100	165					
10.0	100	165					

Set size D:  
197.0 x 87.5 x 23 mm

# SDS-plus-9 RebarCutter

Especially designed for drilling in rebar

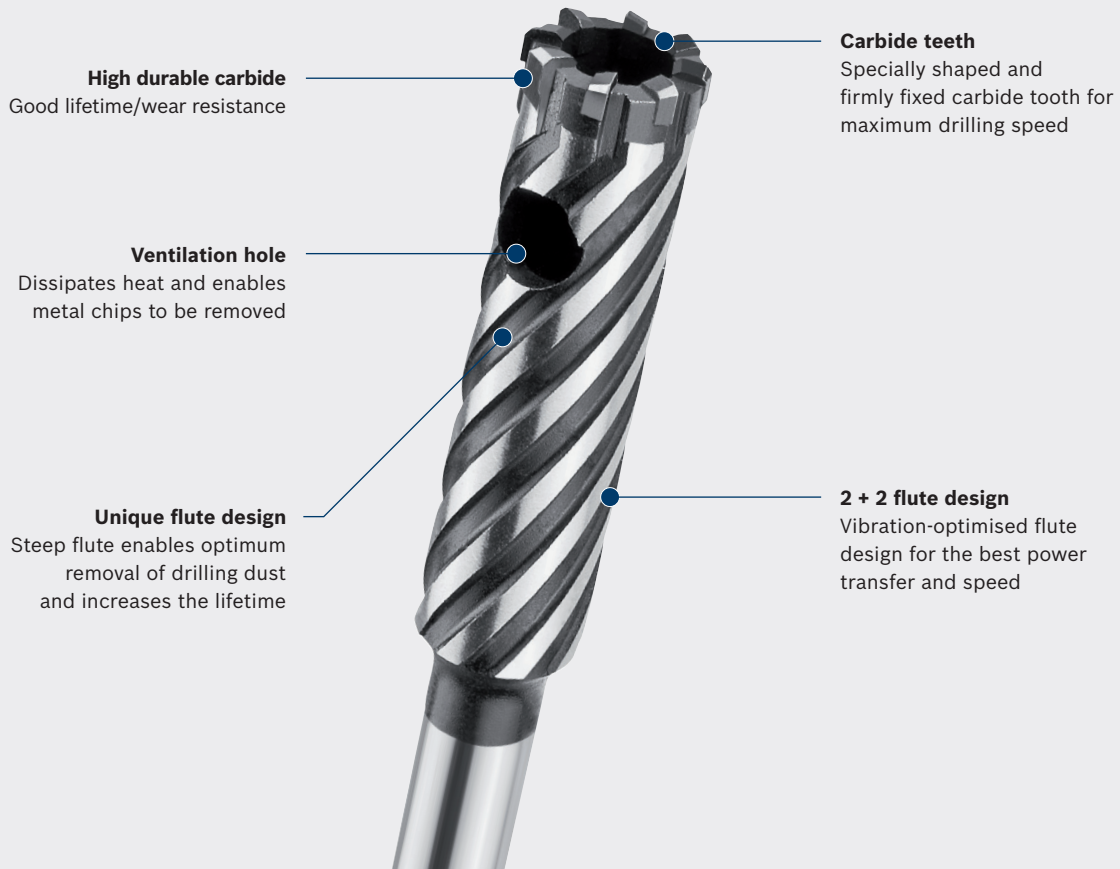

## SDS-plus-9 Rebar Cutter

**SDS-plus-9 RebarCutter** ▶ **Suitable for rebar in concrete**



- ▶ For non-impact use in rotary hammers with SDS-plus holder
- ▶ Only cut through rebar if approval has been issued by a structural engineer
- ▶ Only use the Rebar Cutter without impact

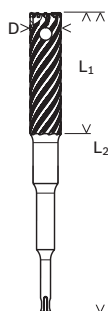

Diameter (D) mm	Working length (L1) mm	Total length (L2) mm	Part number	Packaging type	Pack quantity	Minimum order quantity	Barcode 3163140...
<b>Product properties</b>		<b>Ordering information</b>					
16	120	300	2 608 586 994	P1h	1	1	576673
18	120	300	2 608 586 995	P1h	1	1	576680
20	120	300	2 608 586 996	P1h	1	1	576697
22	120	300	2 608 586 997	P1h	1	1	576703
25	120	300	2 608 586 998	P1h	1	1	576710
28	120	300	2 608 586 999	P1h	1	1	576727
32	120	300	2 608 587 100	P1h	1	1	576734

# SDS-plus-9 CoreCutter

For switch boxes

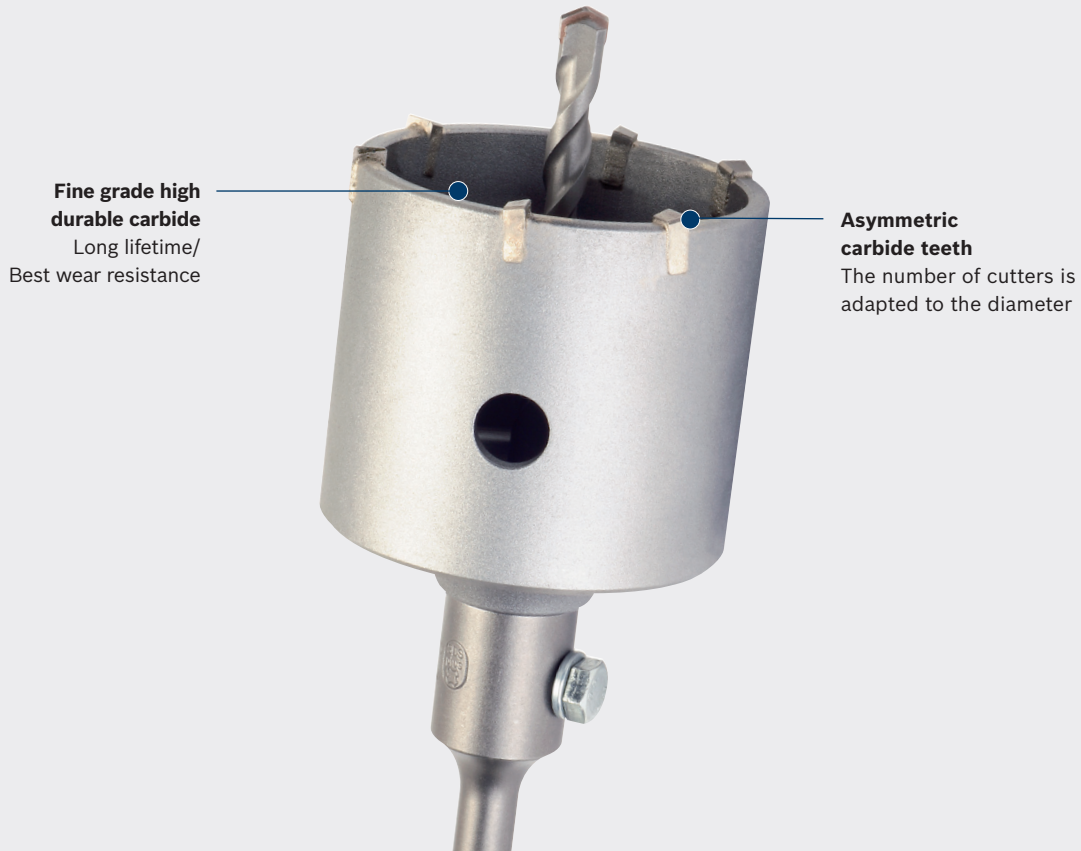

## SDS-plus-9 Core Cutters

**SDS-plus-9 CoreCutter** ▶ **Suitable for concrete, masonry and limestone**



▶ For use with SDS-plus or hex shank



Diameter mm	Working length (L1) mm	Total length (L2) mm	Cutters, number	Part number	Packaging type	Pack quantity	Minimum order quantity	Barcode 3165140...
<b>25</b>	50	72	4	<b>2 608 550 612</b>	P1e	1	1	605328
<b>30</b>	50	72	6	<b>2 608 550 613</b>	P1e	1	1	605335
<b>35</b>	50	72	6	<b>2 608 550 614</b>	P1e	1	1	605342
<b>40</b>	50	72	6	<b>2 608 550 074</b>	P1e	1	1	084642
<b>50</b>	50	72	6	<b>2 608 550 075</b>	P1e	1	1	084659
<b>68</b>	50	72	6	<b>2 608 550 076</b>	P1e	1	1	084666
<b>82</b>	50	72	6	<b>2 608 550 077</b>	P1e	1	1	084673
<b>90</b>	50	72	6	<b>2 608 550 615</b>	P1e	1	1	605359
<b>100</b>	50	72	6	<b>2 608 550 616</b>	P1e	1	1	605366
<b>112</b>	50	72	6	<b>2 608 550 617</b>	P1e	1	1	605373



### Core cutter sets



Product properties				Ordering information					
Diameter mm	Working length (L1) mm	Total length (L2) mm	Cutters, number	Part number	Packaging type	Pack quantity	Minimum order quantity	Barcode 3163140...	

3-piece hex shank core cutter set with pilot drill bit and hex shank



66	50	75	6	2 608 550 088	PC1b	1	1	097420
80	50	75	6	2 608 550 089	PC1b	1	1	097437



3-piece SDS-plus core cutter set SDS-plus shank and pilot drill bit



68	60	75	6	2 608 550 064	PC1b	1	1	046206
82	60	75	6	2 608 550 065	PC1b	1	1	046213

### Accessories for core cutters

Product properties		Ordering information					
Diameter/width across flats mm	Total length mm	Part number	Packaging type	Pack quantity	Minimum order quantity	Barcode 3163140...	

Hex shank for core cutters with M16



11	80	2 608 550 078	P1e	1	1	084680
11	220	2 608 598 109	P1e	1	1	096744

SDS-plus shank for core cutters with M16



-	105	2 608 550 057	P1e	1	1	046138
-	220	2 608 598 110	P1e	1	1	096751

Pilot drill bit for shank for hex adapter and SDS-plus







8	120	2 608 596 157	PC1d	1	5	046114
---	-----	---------------	------	---	---	--------

SDS-plus shank for core cutters with M16, one-piece



-	175	2 608 598 046	P1e	1	1	332224
-	340	2 608 598 047	P1e	1	1	332231
-	440	2 608 598 048	P1e	1	1	332248

# SDS-max shank

	<b>New product</b> Old product	<b>SDS-max-7</b> Speed X	<b>SDS-max-9 BreakThrough</b>	<b>SDS-max-9 CoreCutter</b>	<b>SDS-max-9 NaturalStone</b> RamX
					
Lifetime		●●●●	●●●	●●●●	●●●●●
Speed		●●●●●	●●●	●●●	●●●
Drilling dust removal		●●●●●	●●●●	●●	●●●●
Tip		activeteq			
		Wear indicator			
Cutters		4-cutter solid carbide, vacuum brazing and hardening	3-cutter, vacuum brazing and hardening	Asymmetric carbide teeth	2 main cutters 2 core pins
Carbide		Long-life carbide with extremely fine grain	Long-life carbide with extremely fine grain	Long-life carbide with extremely fine grain	Long-life carbide with extremely fine grain
Flute		2 + 2 flute design			2 + 2 flute design
			2-flute U-shape	Long shank 2-flute U-shape	



**Fast drilling**



**For large holes**



**For switch boxes**



**Long lifetime in natural stone**

●/●● = good

●●●/●●●● = better

●●●●● = best

# SDS-max-7

## Highest drilling speed

**activeteq**  
Active centring tip  
for active cutting in  
concrete



**Fine grade high durable carbide**  
Extra-long life/  
Best wear resistance



**Wear mark**  
The visibility of the wear mark indicates if the hole diameter is still in tolerance for metal anchor setting

**4-cutter; solid carbide**

Extremely robust and aggressive solid carbide S-cutter and inclined side cutters for an aggressive drilling rate

**2 + 2 flute design**

Vibration-optimised flute design for the best power transfer and speed

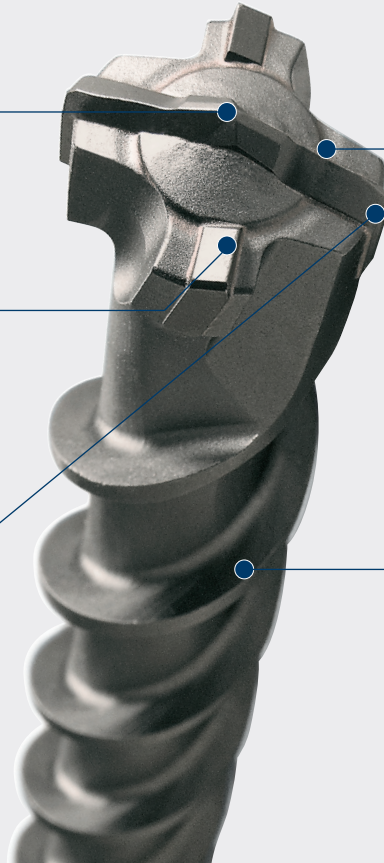

### SDS-max-7 hammer drill bits

**SDS-max-7** ▶ **Suitable for** concrete and reinforced concrete, limestone, masonry

**Speed X**

- ▶ For use in rotary hammers with SDS-max holder
- ▶ Working lengths of 200, 400, 600, 800 and 1200 mm
- ▶ \* 12 to 15 mm diameter bits are two-cutters
- ▶ Reusable packaging

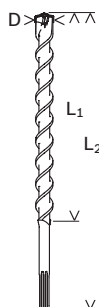

Diameter (D) mm	Working length (L1) mm	Total length (L2) mm	Part number	Packaging type	Pack quantity	Minimum order quantity	Barcode 3165140...
<b>Product properties</b>			<b>Ordering information</b>				
12	200	340	2 608 586 738*	P1h	1	1	564625
12	400	540	2 608 586 739*	P1h	1	1	564632
12	600	740	2 608 586 740*	P1h	1	1	564649
12	800	940	2 608 586 741*	P1h	1	1	564656
14	200	340	2 608 586 744*	P1h	1	1	564687
14	400	540	2 608 586 745*	P1h	1	1	564694
14	600	740	2 608 586 746*	P1h	1	1	564700
14	800	940	2 608 586 747*	P1h	1	1	564717

\* Two-cutter

**SDS-max-7 hammer drill bits**

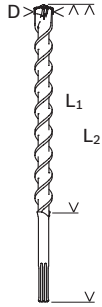

Diameter (D) mm		Working length (L1) mm		Total length (L2) mm		Part number		Packaging type		Pack quantity		Minimum order quantity		Barcode 3165140...	
Product properties				Ordering information											
15	200	340	2 608 586 749*	P1h	1	1	564731								
15	400	540	2 608 586 750*	P1h	1	1	564748								
16	200	340	2 608 586 751	P1h	1	1	564755								
16	400	540	2 608 586 752	P1h	1	1	564762								
16	600	740	2 608 586 753	P1h	1	1	564779								
16	800	940	2 608 586 754	P1h	1	1	564786								
16	1200	1340	2 608 586 755	P1h	1	1	564793								
17	200	340	2 608 586 756	P1h	1	1	564809								
17	400	540	2 608 586 757	P1h	1	1	564816								
18	200	340	2 608 586 758	P1h	1	1	564823								
18	400	540	2 608 586 759	P1h	1	1	564830								
18	600	740	2 608 586 760	P1h	1	1	564847								
18	800	940	2 608 586 761	P1h	1	1	564854								
18	1200	1340	2 608 586 762	P1h	1	1	564861								
19	200	320	2 608 586 763	P1h	1	1	564878								
19	400	520	2 608 586 764	P1h	1	1	565486								
20	200	320	2 608 586 765	P1h	1	1	565493								
20	400	520	2 608 586 766	P1h	1	1	565509								
20	600	720	2 608 586 767	P1h	1	1	565516								
20	800	920	2 608 586 768	P1h	1	1	565523								
20	1200	1320	2 608 586 769	P1h	1	1	565530								
22	200	320	2 608 586 770	P1h	1	1	565547								
22	400	520	2 608 586 771	P1h	1	1	565554								
22	600	720	2 608 586 772	P1h	1	1	565561								
22	800	920	2 608 586 773	P1h	1	1	565578								
22	1200	1320	2 608 586 774	P1h	1	1	565585								
24	200	320	2 608 586 775	P1h	1	1	565592								
24	400	520	2 608 586 776	P1h	1	1	565608								
25	200	320	2 608 586 777	P1h	1	1	565615								
25	400	520	2 608 586 778	P1h	1	1	565622								
25	600	720	2 608 586 779	P1h	1	1	565639								
25	800	920	2 608 586 780	P1h	1	1	565479								
25	1200	1320	2 608 586 781	P1h	1	1	565646								
26	200	320	2 608 586 782	P1h	1	1	565653								
26	400	520	2 608 586 783	P1h	1	1	565660								
28	200	320	2 608 586 784	P1h	1	1	565677								
28	400	520	2 608 586 785	P1h	1	1	565684								
28	600	720	2 608 586 786	P1h	1	1	565691								
28	800	920	2 608 586 787	P1h	1	1	565707								
28	1200	1320	2 608 586 788	P1h	1	1	565714								
30	200	320	2 608 586 789	P1h	1	1	565721								
30	400	520	2 608 586 790	P1h	1	1	565738								
32	200	320	2 608 586 791	P1h	1	1	565745								
32	400	520	2 608 586 792	P1h	1	1	565752								
32	600	720	2 608 586 793	P1h	1	1	565769								
32	800	920	2 608 586 794	P1h	1	1	565776								
32	1200	1320	2 608 586 795	P1h	1	1	565783								
35	400	520	2 608 586 796	P1h	1	1	565790								
35	600	720	2 608 586 797	P1h	1	1	565806								
35	800	920	2 608 586 798	P1h	1	1	565813								
35	1200	1320	2 608 586 799	P1h	1	1	565820								

\* Two-cutter



### SDS-max-7 hammer drill bits

Product properties			Ordering information				
Diameter (D) mm	Working length (L1) mm	Total length (L2) mm	Part number	Packaging type	Pack quantity	Minimum order quantity	Barcode 3165140...
38	400	520	<b>2 608 586 800</b>	P1h	1	1	565462
38	600	720	<b>2 608 586 801</b>	P1h	1	1	565837
40	400	520	<b>2 608 586 802</b>	P1h	1	1	565844
40	600	720	<b>2 608 586 803</b>	P1h	1	1	565851
40	800	920	<b>2 608 586 804</b>	P1h	1	1	565868
40	1200	1320	<b>2 608 586 805</b>	P1h	1	1	565875
45	400	520	<b>2 608 586 806</b>	P1h	1	1	565882
52	400	520	<b>2 608 586 807</b>	P1h	1	1	565899



# SDS-max-9 NaturalStone

Long lifetime drilling in natural stone

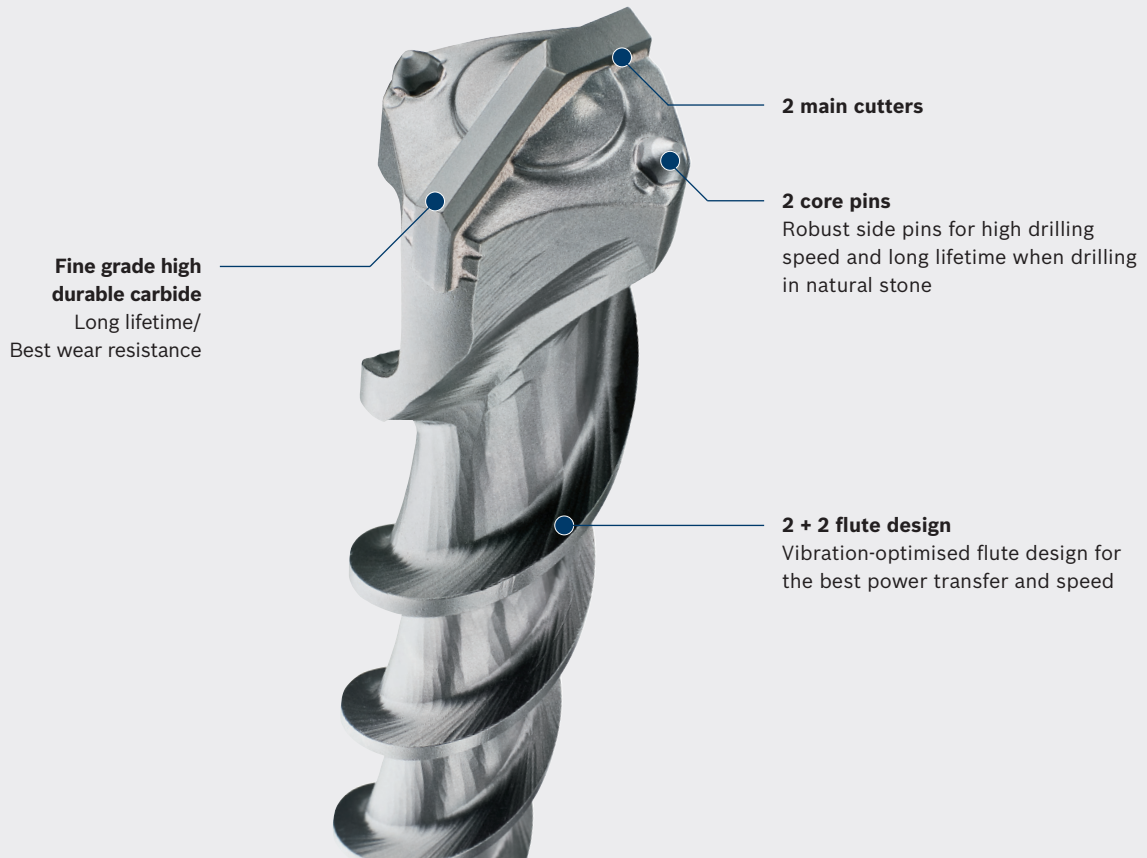

## SDS-max-9 Natural Stone hammer drill bits

- SDS-max-9 NaturalStone** ▶ Suitable for natural stone
- Ram X** ▶ Reusable packaging

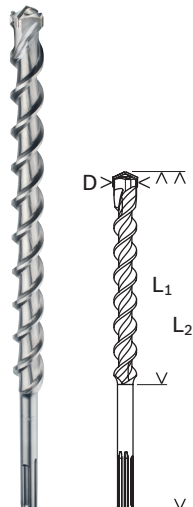

	Diameter (D) mm	Working length (L1) mm	Total length (L2) mm	Part number	Packaging type	Pack quantity	Minimum order quantity	Barcode 3168140...
<b>Product properties</b>			<b>Ordering information</b>					
<b>28</b>	400	520	<b>1 618 596 502</b>	P1h	1	1	560115	
<b>28</b>	600	720	<b>1 618 596 503</b>	P1h	1	1	560122	
<b>28</b>	800	920	<b>1 618 596 504</b>	P1h	1	1	560139	
<b>32</b>	400	520	<b>1 618 596 505</b>	P1h	1	1	560146	
<b>32</b>	600	720	<b>1 618 596 506</b>	P1h	1	1	560153	
<b>32</b>	800	920	<b>1 618 596 507</b>	P1h	1	1	560160	

# SDS-max-9 BreakThrough

For drilling large holes

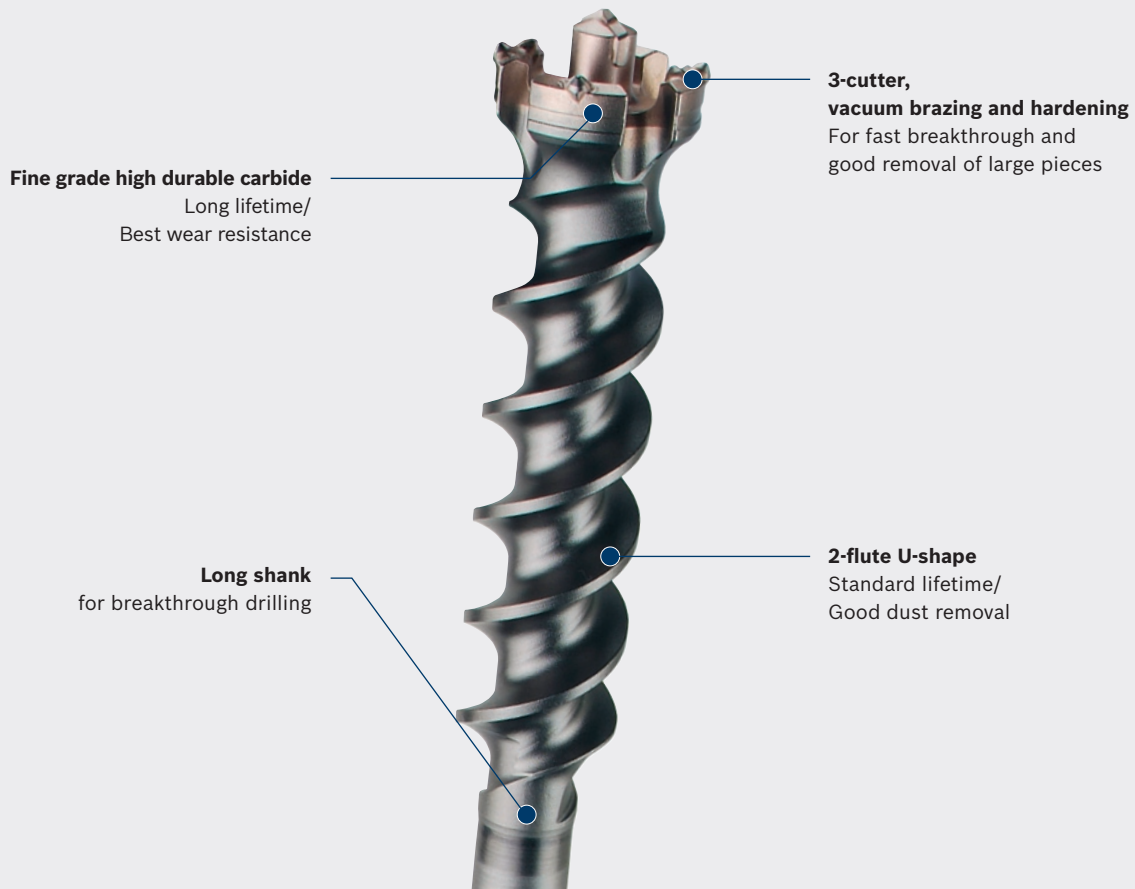

## SDS-max-9 Break Through drill bits

**SDS-max-9 BreakThrough** ▶ **Suitable** for breakthroughs with diameters from 45 mm to 80 mm in concrete, masonry, limestone, e.g. for fixing cables and pipes outside



- ▶ One-piece tool, bell shaped head with asymmetrically positioned carbide pins and centre cutter
- ▶ Large-volume spiral flute, tapered shank
- ▶ **Note:** Always ensure you use hammer drills with suitable capacity for breakthrough drill bits to avoid overload. Observe the operating instructions of the rotary hammer

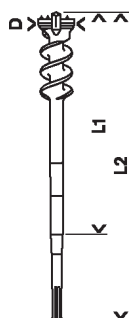

Product properties	Diameter (D) mm	Working length (L1) mm	Total length (L2) mm	Part number	Packaging type	Pack quantity	Minimum order quantity	Barcode 3165140...
	45	450	600	<b>1 618 596 455</b>	P1e	1	1	021951
	45	850	1000	<b>1 618 596 456</b>	P1e	1	1	021968
	55	450	600	<b>1 618 596 457</b>	P1e	1	1	021975
	55	850	1000	<b>1 618 596 458</b>	P1e	1	1	021982

### SDS-max-9 Break Through drill bits

Product properties			Ordering information				
Diameter (D) mm	Working length (L1) mm	Total length (L2) mm	Part number	Packaging type	Pack quantity	Minimum order quantity	Barcode 3165140...
65	450	600	<b>1 618 596 459</b>	P1e	1	1	021999
65	850	1000	<b>1 618 596 460</b>	P1e	1	1	022002
80	450	600	<b>1 618 596 461</b>	P1e	1	1	022019
80	850	1000	<b>1 618 596 462</b>	P1e	1	1	022026



# SDS-max-9 CoreCutter

For switch boxes

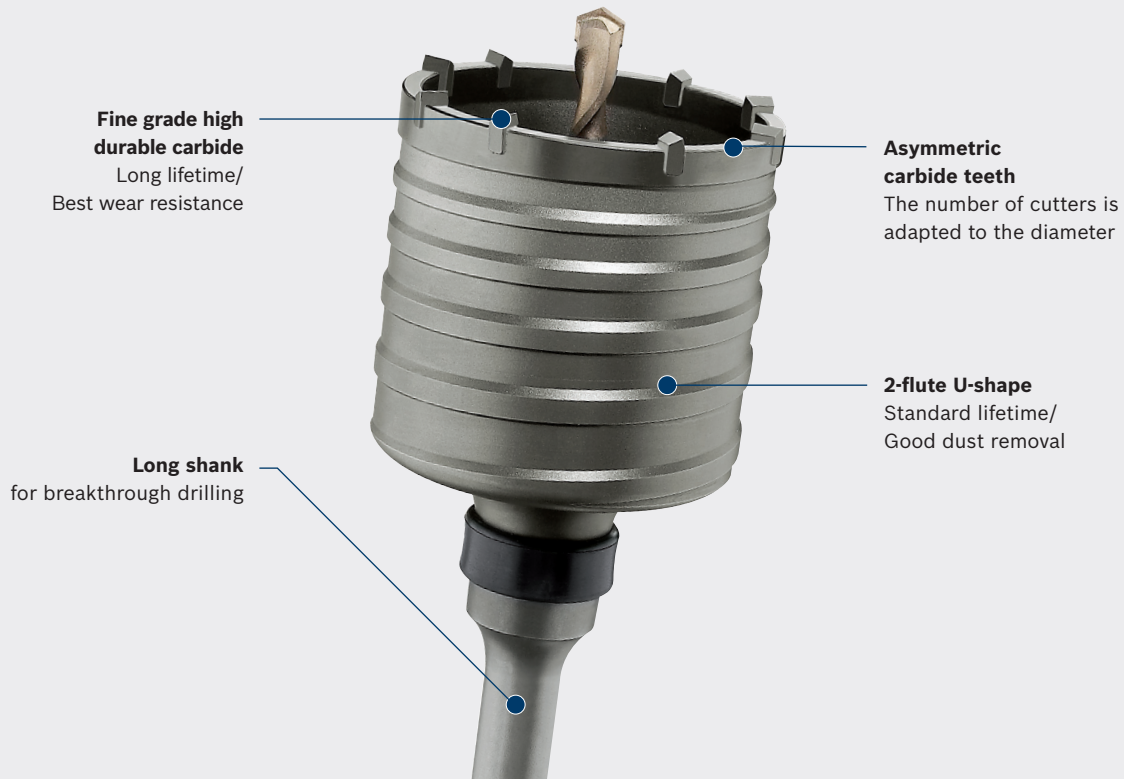

## SDS-max-9 Core Cutters, one-piece

**SDS-max-9 CoreCutter** ▶ **Suitable for concrete, masonry and limestone**



- ▶ One-piece design guarantees optimum transfer of the machine's power
- ▶ Aggressive work progress and simultaneously very quiet during operation thanks to the asymmetric teeth arrangement

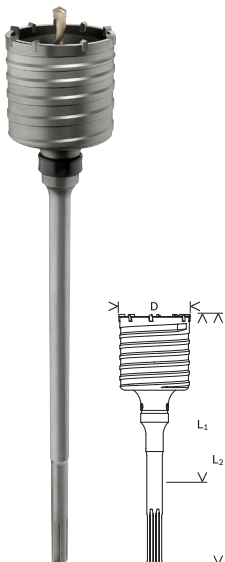

	Diameter mm	Working length (L1) mm	Total length (L2) mm	Cutters, number	Part number	Packaging type	Pack quantity	Minimum order quantity	Barcode 3163140...
<b>Product properties</b>				<b>Ordering information</b>					
	45	160	290	6	<b>F 00Y 145 188</b>	C2h	1	1	145510
	45	420	550	6	<b>F 00Y 145 189</b>	C2h	1	1	145527
	50	160	290	6	<b>F 00Y 145 190</b>	C2h	1	1	145534
	50	420	550	6	<b>F 00Y 145 191</b>	C2h	1	1	145541
	55	160	290	6	<b>F 00Y 145 192</b>	C2h	1	1	145558
	55	420	550	6	<b>F 00Y 145 193</b>	C2h	1	1	145565
	68	160	290	6	<b>F 00Y 145 194</b>	C2h	1	1	145572
	68	420	550	6	<b>F 00Y 145 195</b>	C2h	1	1	145589

### SDS-max-9 Core Cutters, one-piece

Diameter mm	Working length (L1) mm	Total length (L2) mm	Cutters, number	Part number	Packaging type	Pack quantity	Minimum order quantity	Barcode 3165140...
<b>Product properties</b>				<b>Ordering information</b>				
82	160	290	8	F 00Y 145 196	C2h	1	1	145596
82	420	550	8	F 00Y 145 197	C2h	1	1	145602
90	160	290	8	F 00Y 145 198	C2h	1	1	145619
90	420	550	8	F 00Y 145 199	C2h	1	1	145626
100	310	430	11	F 00Y 145 200	C2h	1	1	145633
125	310	430	11	F 00Y 145 201	C2h	1	1	145640
150	310	430	13	F 00Y 145 202	C2h	1	1	145657

### SDS-max-9 Core Cutters, two-piece, with thread



**long LIFE**

► Suitable for concrete, masonry and limestone



Diameter mm	Working length (L1) mm	Cutters, number	Part number	Packaging type	Pack quantity	Minimum order quantity	Barcode 3165140...
<b>Product properties</b>				<b>Ordering information</b>			
SDS-max-9 core cutters, two-piece							
45	80	6	2 608 580 518	C2h	1	1	557733
50	80	6	2 608 580 519	C2h	1	1	557740
55	80	6	2 608 580 520	C2h	1	1	557757
68	80	6	2 608 580 521	C2h	1	1	557764
82	80	8	2 608 580 522	C2h	1	1	557771
90	80	8	2 608 580 523	C2h	1	1	557788
100	80	11	2 608 580 524	C2h	1	1	557795
125	80	11	2 608 580 525	C2h	1	1	557801
150	80	13	2 608 580 526	C2h	1	1	557818

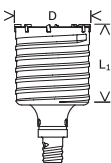

### Accessories for SDS-max core cutters

Diameter (D) mm	Working length (L1) mm	Total length (L2) mm	Part number	Packaging type	Pack quantity	Minimum order quantity	Barcode 3165140...
-----------------	------------------------	----------------------	-------------	----------------	---------------	------------------------	-----------------------

Product properties			Ordering information				
--------------------	--	--	----------------------	--	--	--	--

Adapter for two-piece SDS-max-9 Core Cutters



-	-	200	<b>2 608 580 527</b>	P1e	1	1	560030
-	-	460	<b>2 608 580 528</b>	P1e	1	1	560047

Pilot drill bit



<b>11.5</b>	84	136	<b>F 00Y 145 203</b>	P1c	1	1	145664
-------------	----	-----	----------------------	-----	---	---	--------



Fixing set: fixing pin and rubber ring

<b>5</b>	-	25	<b>F 00Y 145 204</b>	P0b	2	1	145671
----------	---	----	----------------------	-----	---	---	--------



# Chiselling

## 100% Bosch:

the new SDS-max RTec Sharp flat chisel and  
SDS-max RTec Speed pointed chisel





The particularly long, self-sharpening cutting edge has been further enhanced:

- ▶ To remove more material in less time
- ▶ To keep a consistently high removal rate over the chisel's entire lifetime
- ▶ To work efficiently without downtimes and time-consuming resharping

**Increased power output**

100h 0h

+30%

- ▶ No jamming
- ▶ Lifetime of 100 hours
- ▶ 30% higher material removal rate than standard pointed chisels

**Double material removal rate**

50h 0h

long LIFE +100%

- ▶ 100% longer lifetime due to the new self-sharpening cutting edge. Therefore removes twice as much material

**High blast power**

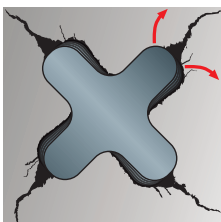

Bosch RTec Speed

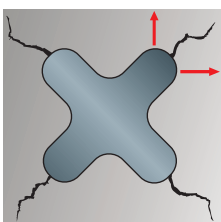

Star Point

**Additional impact energy**

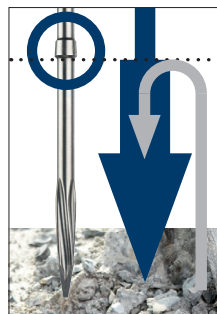

- ▶ The patented reflection element increases the power output: the recoil energy is converted into additional impact energy
- ▶ For an increase in material removal

# The right chisel for any application

Bosch is a strong partner for specialist retailers thanks to its innovative, high-quality tools for working in concrete. With many years of experience in production, state-of-the-art manufacturing technologies and continual development work, Bosch stands for high quality with a power of innovation. Furthermore Bosch offers

the perfect solution for every application: chisels for all conventional shanks and all brands of rotary and demolition hammer. This gives specialist retailers an impressive alternative to the chisels offered in direct distribution.



## SDS-plus for hammers < 5 joules For renovating and restoring

Page 61

Type	Application
Pointed chisel Flat chisel (targeted chiselling)	Adjustment work in masonry and concrete Restoring joints Clearing reinforcements
Spade chisel 40 and 60 mm	Removing roughcasting and layers of dirt Removing concrete residues from formwork boards Restoring steel
Tile chisel	Removing wall and floor tiles
Hollow gouging chisel	Cutting narrow channels in concrete
Winged gouging chisel with channel depth control	Cutting channels in masonry
Pointing chisel	Repointing bricks
Wood chisel	For general carpentry work



## SDS-max for hammers < 25 joules For renovation, restoration, breakthroughs, mortising and demolition work

Page 63

Type	Application
Pointed chisel Flat chisel (targeted chiselling)	Mortising and demolition work in masonry and concrete Adjustment work in masonry and concrete Restoring joints Clearing reinforcements
Spade chisel 50 to 115 mm	Removing roughcasting and layers of dirt Removing concrete residues from formwork boards Restoring steel
Tile chisel	Removing wall and floor tiles
Hollow gouging chisel	Cutting narrow channels in concrete
Gouging chisel	Cutting channels in masonry
Winged gouging chisel with channel depth control	Cutting channels in masonry
Pointing chisel	Repointing bricks
Excavation chisel	Digging in hard, compacted soil

Type	Application
Asphalt cutter	Restoration of asphalt coverings
Earth rod driver	Driving in earth rods
Tamping plates	Compacting soil and gravel
Bush hammer heads	Roughing up concrete and asphalt

## 22 mm hexagon (HEX) appropriate for TE-S system

For breakthroughs, demolition work and correction work

Page 65

Type	Application
Pointed chisel Flat chisel (targeted chiselling)	Mortising and demolition work in masonry and concrete Adjustment work in masonry and concrete Restoring joints Clearing reinforcements
Spade chisel	Adjustment work in asphalt, masonry and concrete
Excavation chisel	Digging in hard, compacted soil
Earth rod driver	Driving in earth rods

## Hex shank (HEX) 28 and 30 mm for hammers > 25 joules

For breakthroughs, mortising and demolition work

Page 65-67

Type	Application
Pointed chisel Flat chisel (targeted chiselling)	Mortising and demolition work in masonry and concrete Restoring joints Clearing reinforcements
Spade chisel	Adjustment work in asphalt, masonry and concrete
Excavation chisel	Digging in hard, compacted soil
Asphalt cutter	Restoration of asphalt coverings
Earth rod driver	Driving in earth rods
Tamping plates	Compacting soil and gravel



Pointed chisel

Flat chisel

Spade chisel

Tile chisel



Hollow gouging chisel

Gouging chisel

Winged gouging chisel

Pointing chisel

Wood chisel



Excavation chisel

Asphalt cutter

Earth rod driver





Tamping plate

Bush hammer head

# Bosch offers the right chisel

for every conventional rotary and demolition hammer



	Supplier of rotary and demolition hammers	Machine model
	<b>22 mm hexagon (HEX) for TE system</b>	<b>Page 65</b>
	Hilti	TE 805, TE 1000 AVR, TE 1500 AVR
	<b>Hex shank WAF 19 with turned down collar</b>	<b>Page 66</b>
	AEG	PH 240 D, PH 350, PH 350 D, PHD 26, PH 38, PHD 38
	Atlas Copco	PB 10 H, PH 5 H, PH 11 H, PHE 50 H
	Black & Decker	HD 2032, HD 2038
	Bosch	11206, 11208, 11209, 11306, UBH 6/35, UBH 6/35 D, UBH 12/50, USH 6, GBH 7/45 DE
	ELU	BH 41 K, BH 41 EK, BH 46 EK
	Hitachi	DH 38 YF, DH 38 YA, DH 50 SB, DH 40 FA/FB
	Kango	430 S, 501 S, 637 S, 950 S, 950 KS, 950 XS, 978 S
	Makita	HR 3850 B, HR 3520 B, HR 4040 C, HR 5000, HM 0810 B, HM 1242 C, HM 1140 C
	Milwaukee	5311, 5312, 5316, 5317, 5347, 5348, 5352, 5353, PH 11 H, PH 40 H
	Ryobi	CH 465, 1138
	<b>Hex shank WAF 19</b>	<b>Page 66</b>
	Atlas Copco	PB 14 D
	Bosch	USH 10 (11305), HSH 10 (12312)
	Casals	Tornado
	DeWalt	DW 558 K
	ELU	SH 60 K
	Hitachi	DH 50 SH 1
	Kango	638 S, 900 B, 900 S, 900 KS, 900 XS, 1400 B
	Makita	HM 1200 B
	Milwaukee	5335
	Ryobi	CH 486 K
	Spit	400
	<b>Hex shank WAF 28</b>	<b>Page 67</b>
	Atlas Copco	PB 32 B
	Bosch	USH 27, GSH 16, GSH 27
	Hitachi	H 65 SD, H 70 SD, H 90 SE
	Makita	HM 1303 B, HM 1304 B, HM 1800, HM 1801, HM 1810
	<b>Hex shank WAF 30</b>	<b>Page 68</b>
	Bosch	GSH 16-30
	Hitachi	H 65 SB, H 65 SB 2, H 70 SA
	Makita	HM 1300, HM 1303, HM 1304, HM 1400, HM 1500, 8900 N
	Ryobi	CH-500 K

# Chisels

for light rotary and demolition hammers



## Chisels with SDS-plus shank



► For use with SDS-plus chisel attachment or directly in SDS-plus hammers with rotation stop



Total length mm	Chisel cutting edge mm	Part number	Packaging type	Pack quantity	Minimum order quantity	Barcode 3165140...
<b>Product properties</b>		<b>Ordering information</b>				

Pointed chisel, Long Life with 30% longer lifetime and 15% higher material removal rate



250	-	2 609 390 576	P1e	1	1	370936
250	-	2 607 019 051	COa	5	1	293136

Flat chisel, Long Life with 30% longer lifetime and 15% higher material removal rate



250	20	2 609 390 394	P1e	1	1	308908
250	20	2 607 019 052	COa	5	1	293143

Spade chisel, self-sharpening, Long Life with 30% higher material removal rate



250	40	2 608 690 101	P1e	1	1	425940
250	60	2 608 690 102	P1e	1	1	425957

Tile chisel, angled, self-sharpening, Long Life with 30% higher material removal rate



260	40	2 608 690 091	P1e	1	1	328012
-----	----	---------------	-----	---	---	--------

3-piece chisel set

- 1 pointed chisel 250 mm, Long Life (2 609 390 576)
- 1 flat chisel 250 mm, Long Life (2 609 390 394)
- 1 tile chisel 260 mm, self-sharpening (2 608 690 091)

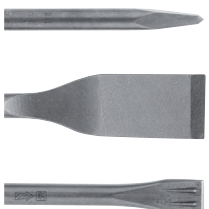

250	20	2 607 019 159	P1c	3	1	334488
250	40					
260						

### Chisels with SDS-plus shank

Product properties		Ordering information					
Total length mm	Chisel cutting edge mm	Part number	Packaging type	Pack quantity	Minimum order quantity	Barcode	3165140...

**Pointed chisel**



140	-	2 608 690 176	P1e	1	1	608398	
250	-	2 608 690 145	P1e	1	1	506489	
250	-	2 608 690 132	U0	10	1	462792	

**Pointed chisel for rotary hammers without rotation stop**



250	-	1 618 600 005	P1e	1	1	006347	
-----	---	---------------	-----	---	---	--------	--

**Flat chisel**



140	20	2 608 690 177	P1e	1	1	608404	
250	20	2 608 690 144	P1e	1	1	506472	
250	20	2 608 690 131	U0	10	1	462785	

**Spade chisel**



140	40	2 608 690 178	P1e	1	1	608411	
250	40	2 608 690 146	P1e	1	1	506496	
250	40	2 608 690 133	U0	5	1	462808	

**3-piece stubby chisel set**



Pointed chisel 140 mm



Flat chisel 140 x 20 mm



Spade chisel 140 x 40 mm

140	20	2 608 690 180	P1e	3	1	610681	
140	40						
140							

**Hollow gouging chisel**



250	22	1 618 601 004	P1e	1	1	015844	
-----	----	---------------	-----	---	---	--------	--



**Winged gouging chisel/Gouging chisel**

250	22	2 608 690 007	P1e	1	1	086738	
-----	----	---------------	-----	---	---	--------	--

**Pointing chisel, carbide-tipped**



130	32	1 608 690 014	P1e	1	1	045803	
200	32	1 608 690 015	P1e	1	1	045810	



**Wood chisel**

175	20	2 608 690 006	P1e	1	1	086721	
-----	----	---------------	-----	---	---	--------	--

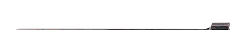

**Rod driver, 13 mm diameter**

58	-	2 608 690 010	P1e	1	1	086769	
----	---	---------------	-----	---	---	--------	--



**MV 200 chisel attachment for Bosch hammers with SDS-plus holder, without Vario-Lock system**

-	-	2 607 018 296	P1e	1	1	081276	
---	---	---------------	-----	---	---	--------	--

# Chisels

for heavy rotary and demolition hammers

## Chisels with SDS-max shank

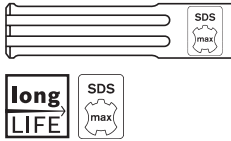

Total length mm	Chisel cutting edge mm	Part number	Packaging type	Pack quantity	Minimum order quantity	Barcode 3165140...
Product properties		Ordering information				

RTec Speed pointed chisel, self-sharpening with 30% higher material removal rate



400	-	2 608 690 167	P1e	1	1	533621
400	-	2 608 690 168	C0a	10	1	533638

RTec Sharp flat chisel, self-sharpening, Long Life with 100% higher material removal rate



400	25	2 608 690 124	P1e	1	1	460385
400	25	2 608 690 166	C0a	10	1	530200

Spade chisel, self-sharpening, Long Life with 30% higher material removal rate



350	50	2 608 690 097	P1e	1	2	397315
350	50	2 608 690 099	C0a	5	1	402996
400	80	2 608 690 198	P1e	1	1	670135
400	115	2 608 690 199	P1e	1	1	670142

Tile chisel, self-sharpening, Long Life with 30% higher material removal rate



300	50	2 608 690 098	P1e	1	1	397322
300	50	2 608 690 100	C0a	5	1	403009

Pointed chisel



280	-	1 618 600 023	P1e	1	1	047272
280	-	2 608 690 130	U0	10	1	462778
400	-	2 608 690 142	P1e	1	1	506458
400	-	2 608 690 128	U0	10	1	462754
600	-	1 618 600 012	P1e	1	1	022118
600	-	2 608 690 129	U0	5	1	462761

Flat chisel















280	25	1 618 600 210	P1e	1	1	047296
280	25	2 608 690 127	U0	10	1	462747
400	25	2 608 690 141	P1e	1	1	506441
400	25	2 608 690 125	U0	10	1	462723
600	25	1 618 600 203	P1e	1	1	022132
600	25	2 608 690 126	U0	5	1	462730

Spade chisel

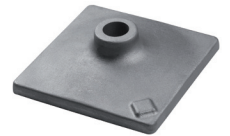

400	50	2 608 690 143	P1e	1	1	506465
400	50	2 608 587 184	U0	5	1	605786
300	80	1 618 601 008	P1e	1	1	033398
350	115	1 618 601 007	P1e	1	1	022156

Chisels with SDS-max shank

	Total length mm	Chisel cutting edge mm	Dimensions mm	Number of teeth	Part number	Packaging type	Pack quantity	Minimum order quantity	Barcode 3165140...				
	<b>Product properties</b>				<b>Ordering information</b>								
Tile chisel	300	80	-	-	1 618 601 019	P1e	1	1	052979				
	300	26	-	-	1 618 601 101	P1e	1	1	022163				
	300	32	-	-	1 618 601 102	P1e	1	1	022170				
	380	35	-	-	2 608 690 000	P1e	1	1	069380				
	280	38	-	-	2 607 990 010	P1e	1	1	058414				
	300	32	-	-	1 618 601 302	P1e	1	1	022194				
	400	110	-	-	1 618 601 017	P1e	1	1	049283				
	400	90	-	-	2 608 690 003	P1e	1	1	079761				
	260	13	-	-	2 608 690 004	P1e	1	1	079778				
	260	16.5	-	-	2 608 690 005	P1e	1	1	079785				
	Tamping plate for toolholder 1 618 609 003				-	-	120 x 120	-	1 618 633 101	PC1c	1	1	029339
					-	-	150 x 150	-	1 618 633 102	PC1c	1	1	029346
	Bush hammer head for toolholder 1 618 609 003				-	-	50 x 50	5 x 5	2 608 690 179	C0a	1	1	608428
	Bush hammer head for toolholder 1 618 609 003				-	-	60 x 60	5 x 5	1 618 623 205	PC1c	1	1	029025
					-	-	60 x 60	7 x 7	1 618 623 206	PC1c	1	1	029032
	Toolholder for tamping plates and bush hammer heads				220	-	-	-	1 618 609 003	P1e	1	1	022200



### Chisels with 22 mm hex shank



► **Appropriate for TE-S system**



Product properties				Ordering information						
Total length mm	Chisel cutting edge mm	Dimensions mm	Number of teeth	Part number	Packaging type	Pack quantity	Minimum order quantity	Barcode 3165140...		

Self-sharpening pointed chisel



400	-	-	-	<b>2 608 690 188</b>	U0	1	1	670036	
-----	---	---	---	----------------------	----	---	---	--------	--

Self-sharpening flat chisel



400	25	-	-	<b>2 608 690 190</b>	U0	1	1	670050	
-----	----	---	---	----------------------	----	---	---	--------	--

Self-sharpening spade chisel



400	50	-	-	<b>2 608 690 192</b>	U0	1	1	670074	
400	80	-	-	<b>2 608 690 193</b>	U0	1	1	670081	
400	115	-	-	<b>2 608 690 194</b>	U0	1	1	670098	



Excavation chisel

400	125	-	-	<b>2 608 690 195</b>	U0	1	1	670104	
-----	-----	---	---	----------------------	----	---	---	--------	--



Earth rod driver

300	25	-	-	<b>2 608 690 196</b>	U0	1	1	670111	
-----	----	---	---	----------------------	----	---	---	--------	--



Toolholder for tamping plate

300	-	-	-	<b>2 608 690 197</b>	U0	1	1	670128	
-----	---	---	---	----------------------	----	---	---	--------	--

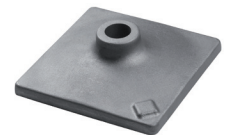

Tamping plate for toolholder 1 618 609 003

-	-	120 x 120	-	<b>1 618 633 101</b>	PC1c	1	1	029339	
---	---	-----------	---	----------------------	------	---	---	--------	--

### Chisels with 19 mm hex shank with turned down collar (17 mm diameter)

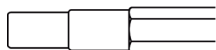

Total length mm	Chisel cutting edge mm	Part number	Packaging type	Pack quantity	Minimum order quantity	Barcode 3165140...
Product properties		Ordering information				

Pointed chisel



400	-	1 618 630 002	P0b	1	1	029063
-----	---	---------------	-----	---	---	--------

Flat chisel



400	22	1 618 630 003	P0b	1	1	029070
-----	----	---------------	-----	---	---	--------

Spade chisel



400	50	1 618 630 007	P0b	1	1	029117
-----	----	---------------	-----	---	---	--------

### Chisels with 19 mm hex shank

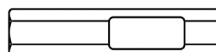

Pointed chisel



300	-	1 618 630 000	P0b	1	1	029049
400	-	1 618 630 001	P0b	1	1	029056

Flat chisel



300	25	1 618 630 200	P0b	1	1	029193
400	25	1 618 630 201	P0b	1	1	029209

Spade chisel



450	60	1 618 631 001	P0b	1	1	029247
-----	----	---------------	-----	---	---	--------

# Chisels

## for breakers

### Chisels with 28 mm hex shank

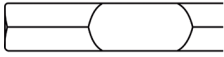

Total length mm	Chisel cutting edge mm	Dimensions mm	Part number	Packaging type	Pack quantity	Minimum order quantity	Barcode 3165140...
Product properties			Ordering information				

Pointed chisel, self-sharpening



400	-	-	2 608 690 106	U0	1	1	425995
-----	---	---	---------------	----	---	---	--------

Pointed chisel



520	-	-	1 618 600 019	U0	1	1	042543
-----	---	---	---------------	----	---	---	--------

Flat chisel



400	35	-	2 608 690 108	U0	1	1	426015
520	35	-	1 618 600 206	U0	1	1	042550

Spade chisel



400	80	-	1 618 661 000	U0	1	1	029414
-----	----	---	---------------	----	---	---	--------

Asphalt cutter



500	125	-	1 618 601 011	U0	1	1	042574
-----	-----	---	---------------	----	---	---	--------

Rounded spade chisel

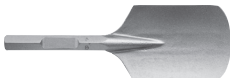

400	135	-	1 618 662 000	U0	1	1	029421
-----	-----	---	---------------	----	---	---	--------

Earth rod driver

for hammering in rods and rings up to 1" (25.4 mm) head diameter



300	-	-	1 618 609 005	U0	1	1	042604
-----	---	---	---------------	----	---	---	--------

Toolholder for tamping plates



390	-	-	1 618 609 006	U0	1	1	042611
-----	---	---	---------------	----	---	---	--------

Tamping plate for toolholder 1 618 609 006 or 2 608 690 115  
for compressing soil with a work surface of 225 cm<sup>2</sup> (1 618 633 104)  
or 400 cm<sup>2</sup> (1 618 633 105)

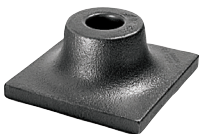

-	-	150 x 150	1 618 633 104	C0a	1	1	042628
-	-	200 x 200	1 618 633 105	C0a	1	1	042635



Transport cart

Appropriate for USH/GSH 27 Professional

-	-	-	1 610 795 007	C0a	1	1	042642
---	---	---	---------------	-----	---	---	--------

### Chisels with 30 mm hex shank

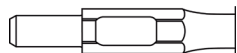

**long**  
**LIFE**

Total length mm	Chisel cutting edge mm	Dimensions mm	Part number	Packaging type	Pack quantity	Minimum order quantity	Barcode 3165140...
<b>Product properties</b>			<b>Ordering information</b>				

Pointed chisel, self-sharpening



400	-	-	<b>2 608 690 111</b>	U0	1	1	426046
-----	---	---	----------------------	----	---	---	--------

Flat chisel



400	35	-	<b>2 608 690 112</b>	U0	1	1	426053
-----	----	---	----------------------	----	---	---	--------

Spade chisel



450	75	-	<b>2 608 690 113</b>	U0	1	1	426060
-----	----	---	----------------------	----	---	---	--------

Asphalt cutter



450	125	-	<b>2 608 690 114</b>	U0	1	1	426077
-----	-----	---	----------------------	----	---	---	--------

Spade chisel, rounded



400	135	-	<b>2 608 690 110</b>	U0	1	1	426039
-----	-----	---	----------------------	----	---	---	--------

Toolholder



400	-	-	<b>2 608 690 115</b>	U0	1	1	426084
-----	---	---	----------------------	----	---	---	--------

Tamping plate for toolholder 1 618 609 006 or 2 608 690 115  
for compressing soil with a work surface of 225 cm<sup>2</sup> (1 618 633 104)  
or 400 cm<sup>2</sup> (1 618 633 105)

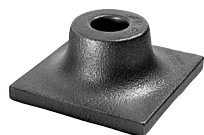

-	-	150 x 150	<b>1 618 633 104</b>	C0a	1	1	042628
-	-	200 x 200	<b>1 618 633 105</b>	C0a	1	1	042635

# Part number index

Part number	Page	MOQ*	Part number	Page	MOQ*	Part number	Page	MOQ*	Part number	Page	MOQ*
1 608 690 014	62	1	1 618 596 462	51	1	2 608 580 519	53	1	2 608 585 618	40	1
1 608 690 015	62	1	1 618 596 502	49	1	2 608 580 520	53	1	2 608 585 619	40	1
1 609 200 204	26	5	1 618 596 503	49	1	2 608 580 521	53	1	2 608 585 620	40	1
1 609 200 205	24	5	1 618 596 504	49	1	2 608 580 522	53	1	2 608 585 621	40	1
1 609 200 206	24	5	1 618 596 505	49	1	2 608 580 523	53	1	2 608 585 622	40	1
1 609 200 207	25	5	1 618 596 506	49	1	2 608 580 524	53	1	2 608 585 623	40	1
1 609 200 209	25	5	1 618 596 507	49	1	2 608 580 525	53	1	2 608 585 624	40	1
1 609 200 210	25	5	1 618 600 005	62	1	2 608 580 526	53	1	2 608 585 625	40	1
1 609 200 212	25	1	1 618 600 012	63	1	2 608 580 527	54	1	2 608 585 626	40	1
1 609 200 213	25	1	1 618 600 019	67	1	2 608 580 528	54	1	2 608 585 627	40	1
1 610 795 007	67	1	1 618 600 023	63	1	2 608 585 023	33	1	2 608 585 628	40	1
1 617 000 117	41	5	1 618 600 203	63	1	2 608 585 024	33	1	2 608 585 629	40	1
1 617 000 118	41	5	1 618 600 206	67	1	2 608 585 025	33	1	2 608 585 630	40	1
1 618 596 164	38	5	1 618 600 210	63	1	2 608 585 026	33	1	2 608 585 631	40	1
1 618 596 165	38	5	1 618 601 004	62	1	2 608 585 027	33	1	2 608 585 634	21	1
1 618 596 166	38	5	1 618 601 007	63	1	2 608 585 028	33	1	2 608 585 943	34	1
1 618 596 167	38	5	1 618 601 008	63	1	2 608 585 029	33	1	2 608 585 944	34	1
1 618 596 168	38	5	1 618 601 011	67	1	2 608 585 030	33	1	2 608 585 945	34	1
1 618 596 169	38	5	1 618 601 017	64	1	2 608 585 031	33	1	2 608 585 946	34	1
1 618 596 170	38	5	1 618 601 019	64	1	2 608 585 032	34	1	2 608 585 947	34	1
1 618 596 171	38	5	1 618 601 101	64	1	2 608 585 033	34	1	2 608 585 948	34	1
1 618 596 172	38	5	1 618 601 102	64	1	2 608 585 035	34	1	2 608 585 949	35	1
1 618 596 173	38	5	1 618 601 302	64	1	2 608 585 036	34	1	2 608 585 950	35	1
1 618 596 174	38	5	1 618 609 003	64, 65	1	2 608 585 037	34	1	2 608 585 951	35	1
1 618 596 175	38	5	1 618 609 005	67	1	2 608 585 038	34	1	2 608 585 952	39	1
1 618 596 176	38	5	1 618 609 006	67, 68	1	2 608 585 039	34	1	2 608 585 953	39	1
1 618 596 177	38	5	1 618 623 205	64	1	2 608 585 040	34	1	2 608 586 276	25	1
1 618 596 178	38	5	1 618 623 206	64	1	2 608 585 041	34	1	2 608 586 455	35	1
1 618 596 179	39	5	1 618 630 000	66	1	2 608 585 042	34	1	2 608 586 456	35	1
1 618 596 180	39	5	1 618 630 001	66	1	2 608 585 043	34	1	2 608 586 457	35	1
1 618 596 181	39	5	1 618 630 002	66	1	2 608 585 044	34	1	2 608 586 458	35	1
1 618 596 182	39	5	1 618 630 003	66	1	2 608 585 045	34	1	2 608 586 459	35	1
1 618 596 183	39	5	1 618 630 007	66	1	2 608 585 046	34	1	2 608 586 460	35	1
1 618 596 184	39	5	1 618 630 200	66	1	2 608 585 047	34	1	2 608 586 461	35	1
1 618 596 185	39	5	1 618 630 201	66	1	2 608 585 048	34	1	2 608 586 462	35	1
1 618 596 186	39	5	1 618 631 001	66	1	2 608 585 049	34	1	2 608 586 463	35	1
1 618 596 187	39	5	1 618 633 101	64, 65	1	2 608 585 050	34	1	2 608 586 464	35	1
1 618 596 188	39	5	1 618 633 102	64	1	2 608 585 051	34	1	2 608 586 465	35	1
1 618 596 189	38	5	1 618 633 104	67, 68	1	2 608 585 052	34	1	2 608 586 719	34	1
1 618 596 203	39	1	1 618 633 105	67, 68	1	2 608 585 053	34	1	2 608 586 720	34	1
1 618 596 204	39	5	1 618 661 000	67	1	2 608 585 054	34	1	2 608 586 721	34	1
1 618 596 205	39	1	1 618 662 000	67	1	2 608 585 055	35	1	2 608 586 722	34	1
1 618 596 207	39	1	2 607 010 521	29	1	2 608 585 056	35	1	2 608 586 723	34	1
1 618 596 224	39	1	2 607 010 522	29	1	2 608 585 057	35	1	2 608 586 724	34	1
1 618 596 225	39	1	2 607 010 543	29	1	2 608 585 058	35	1	2 608 586 725	34	1
1 618 596 226	39	1	2 607 010 546	29	1	2 608 585 059	35	1	2 608 586 726	34	1
1 618 596 231	37	5	2 607 017 035	26	2	2 608 585 060	35	1	2 608 586 727	34	1
1 618 596 232	39	1	2 607 017 038	26	1	2 608 585 061	35	1	2 608 586 728	34	1
1 618 596 233	39	1	2 607 017 079	26	4	2 608 585 062	35	1	2 608 586 738	46	1
1 618 596 236	39	1	2 607 017 080	23	4	2 608 585 063	35	1	2 608 586 739	46	1
1 618 596 237	39	1	2 607 017 081	23	4	2 608 585 064	35	1	2 608 586 740	46	1
1 618 596 238	40	1	2 607 017 082	23	4	2 608 585 065	35	1	2 608 586 741	46	1
1 618 596 239	40	1	2 607 017 083	23	4	2 608 585 066	35	1	2 608 586 744	46	1
1 618 596 240	40	1	2 607 018 296	62	1	2 608 585 067	35	1	2 608 586 745	46	1
1 618 596 241	40	1	2 607 018 367	26	1	2 608 585 068	35	1	2 608 586 746	46	1
1 618 596 257	39	1	2 607 019 051	61	1	2 608 585 069	35	1	2 608 586 747	46	1
1 618 596 259	39	1	2 607 019 052	61	1	2 608 585 073	36	1	2 608 586 749	47	1
1 618 596 260	39	1	2 607 019 159	61	1	2 608 585 223	28	5	2 608 586 750	47	1
1 618 596 261	39	1	2 607 019 927	41	1	2 608 585 224	28	5	2 608 586 751	47	1
1 618 596 262	39	1	2 607 019 928	41	1	2 608 585 225	20	5	2 608 586 752	47	1
1 618 596 263	39	1	2 607 019 929	41	1	2 608 585 596	37	5	2 608 586 753	47	1
1 618 596 264	38	5	2 607 019 932	36	1	2 608 585 597	38	5	2 608 586 754	47	1
1 618 596 265	38	5	2 607 019 933	36	1	2 608 585 598	38	5	2 608 586 755	47	1
1 618 596 267	38	1	2 607 990 010	64	1	2 608 585 599	38	1	2 608 586 756	47	1
1 618 596 268	39	5	2 608 550 057	44	1	2 608 585 600	38	5	2 608 586 757	47	1
1 618 596 269	39	1	2 608 550 064	44	1	2 608 585 601	38	1	2 608 586 758	47	1
1 618 596 270	39	5	2 608 550 065	44	1	2 608 585 602	38	5	2 608 586 759	47	1
1 618 596 271	39	5	2 608 550 074	43	1	2 608 585 603	38	1	2 608 586 760	47	1
1 618 596 315	38	5	2 608 550 075	43	1	2 608 585 604	38	5	2 608 586 761	47	1
1 618 596 316	39	5	2 608 550 076	43	1	2 608 585 605	38	5	2 608 586 762	47	1
1 618 596 318	39	5	2 608 550 077	43	1	2 608 585 607	39	1	2 608 586 763	47	1
1 618 596 319	39	1	2 608 550 078	44	1	2 608 585 608	40	1	2 608 586 764	47	1
1 618 596 320	39	1	2 608 550 088	44	1	2 608 585 609	40	1	2 608 586 765	47	1
1 618 596 321	39	1	2 608 550 089	44	1	2 608 585 610	40	1	2 608 586 766	47	1
1 618 596 455	50	1	2 608 550 612	43	1	2 608 585 611	40	1	2 608 586 767	47	1
1 618 596 456	50	1	2 608 550 613	43	1	2 608 585 612	40	1	2 608 586 768	47	1
1 618 596 457	50	1	2 608 550 614	43	1	2 608 585 613	40	1	2 608 586 769	47	1
1 618 596 458	50	1	2 608 550 615	43	1	2 608 585 614	40	1	2 608 586 770	47	1
1 618 596 459	51	1	2 608 550 616	43	1	2 608 585 615	40	1	2 608 586 771	47	1
1 618 596 460	51	1	2 608 550 617	43	1	2 608 585 616	40	1	2 608 586 772	47	1
1 618 596 461	51	1	2 608 580 518	53	1	2 608 585 617	40	1	2 608 586 773	47	1

Part number	Page	MOQ*	Part number	Page	MOQ*	Part number	Page	MOQ*	Part number	Page	MOQ*
2 608 586 774	47	1	2 608 588 136	17	5	2 608 596 135	25	5	2 608 597 691	21	1
2 608 586 775	47	1	2 608 588 137	17	5	2 608 596 136	25	5	2 608 597 692	21	1
2 608 586 776	47	1	2 608 588 138	17	5	2 608 596 137	25	1	2 608 597 693	21	1
2 608 586 777	47	1	2 608 588 139	17	5	2 608 596 138	25	1	2 608 597 694	21	1
2 608 586 778	47	1	2 608 588 140	17	5	2 608 596 139	25	1	2 608 597 695	21	1
2 608 586 779	47	1	2 608 588 141	17	5	2 608 596 140	25	1	2 608 597 696	21	1
2 608 586 780	47	1	2 608 588 142	18	5	2 608 596 141	25	1	2 608 597 697	21	1
2 608 586 781	47	1	2 608 588 143	18	5	2 608 596 142	25	1	2 608 597 698	21	1
2 608 586 782	47	1	2 608 588 144	18	5	2 608 596 143	25	5	2 608 597 699	21	1
2 608 586 783	47	1	2 608 588 145	18	5	2 608 596 145	25	5	2 608 597 700	21	1
2 608 586 784	47	1	2 608 588 146	18	5	2 608 596 146	38	5	2 608 597 701	21	1
2 608 586 785	47	1	2 608 588 147	18	5	2 608 596 148	25	5	2 608 597 702	21	1
2 608 586 786	47	1	2 608 588 148	18	5	2 608 596 149	25	5	2 608 597 703	21	1
2 608 586 787	47	1	2 608 588 149	18	5	2 608 596 150	25	1	2 608 597 704	22	1
2 608 586 788	47	1	2 608 588 150	18	5	2 608 596 151	25	1	2 608 597 705	22	1
2 608 586 789	47	1	2 608 588 151	18	5	2 608 596 152	25	1	2 608 597 706	22	1
2 608 586 790	47	1	2 608 588 152	18	1	2 608 596 157	44	5	2 608 597 707	22	1
2 608 586 791	47	1	2 608 588 153	18	5	2 608 596 158	38	5	2 608 597 708	22	1
2 608 586 792	47	1	2 608 588 154	18	5	2 608 596 183	38	1	2 608 597 709	22	5
2 608 586 793	47	1	2 608 588 155	18	1	2 608 596 185	39	1	2 608 597 713	22	1
2 608 586 794	47	1	2 608 588 156	18	5	2 608 596 186	39	1	2 608 597 714	22	1
2 608 586 795	47	1	2 608 588 157	18	1	2 608 596 199	38	5	2 608 597 715	22	1
2 608 586 796	47	1	2 608 588 158	18	1	2 608 596 357	25	5	2 608 597 716	22	1
2 608 586 797	47	1	2 608 588 159	18	1	2 608 596 358	25	1	2 608 597 717	22	1
2 608 586 798	47	1	2 608 588 160	18	1	2 608 596 359	25	5	2 608 597 718	22	1
2 608 586 799	47	1	2 608 588 161	18	1	2 608 596 361	25	1	2 608 597 719	22	1
2 608 586 800	48	1	2 608 588 162	18	1	2 608 596 362	25	5	2 608 597 720	22	1
2 608 586 801	48	1	2 608 588 163	18	5	2 608 596 364	25	1	2 608 597 721	22	1
2 608 586 802	48	1	2 608 588 164	18	1	2 608 596 365	25	5	2 608 597 773	37	5
2 608 586 803	48	1	2 608 588 165	19	1	2 608 596 366	25	1	2 608 597 774	37	5
2 608 586 804	48	1	2 608 588 167	19	1	2 608 596 368	25	5	2 608 597 775	38	5
2 608 586 805	48	1	2 608 588 196	27	1	2 608 596 369	25	1	2 608 597 776	38	5
2 608 586 806	48	1	2 608 588 197	27	1	2 608 597 041	25	1	2 608 597 777	38	5
2 608 586 807	48	1	2 608 588 198	27	1	2 608 597 043	25	1	2 608 597 778	38	5
2 608 586 994	42	1	2 608 588 199	27	1	2 608 597 044	25	1	2 608 597 779	38	5
2 608 586 995	42	1	2 608 588 200	27	1	2 608 597 047	25	1	2 608 597 780	38	5
2 608 586 996	42	1	2 608 588 201	28	1	2 608 597 048	25	1	2 608 597 782	39	5
2 608 586 997	42	1	2 608 588 202	28	1	2 608 597 049	25	1	2 608 597 898	21	5
2 608 586 998	42	1	2 608 588 203	28	1	2 608 597 051	25	1	2 608 597 899	21	5
2 608 586 999	42	1	2 608 588 204	28	1	2 608 597 052	25	1	2 608 597 944	38	5
2 608 587 100	42	1	2 608 588 205	28	1	2 608 597 054	25	1	2 608 598 046	44	1
2 608 587 146	28	1	2 608 588 206	28	1	2 608 597 055	25	1	2 608 598 047	44	1
2 608 587 147	28	1	2 608 588 207	28	1	2 608 597 122	38	1	2 608 598 048	44	1
2 608 587 148	28	1	2 608 588 208	28	1	2 608 597 123	39	1	2 608 598 109	44	1
2 608 587 149	28	1	2 608 588 209	28	1	2 608 597 124	39	1	2 608 598 110	44	1
2 608 587 150	28	1	2 608 588 210	28	1	2 608 597 125	39	1	2 608 690 000	64	1
2 608 587 151	28	1	2 608 588 211	28	1	2 608 597 126	39	1	2 608 690 003	64	1
2 608 587 152	28	1	2 608 588 212	28	5	2 608 597 127	39	1	2 608 690 004	64	1
2 608 587 153	28	1	2 608 595 359	27	5	2 608 597 128	39	1	2 608 690 005	64	1
2 608 587 157	30	5	2 608 595 360	28	1	2 608 597 129	40	1	2 608 690 006	62	1
2 608 587 158	30	5	2 608 595 361	28	1	2 608 597 130	38	5	2 608 690 007	62	1
2 608 587 159	30	5	2 608 595 506	28	1	2 608 597 655	20	5	2 608 690 010	62	1
2 608 587 160	30	5	2 608 595 507	28	1	2 608 597 656	20	5	2 608 690 091	61	1
2 608 587 161	30	5	2 608 595 508	28	1	2 608 597 657	20	5	2 608 690 097	63	2
2 608 587 162	30	5	2 608 596 050	27	5	2 608 597 658	20	5	2 608 690 098	63	1
2 608 587 163	31	5	2 608 596 051	27	5	2 608 597 659	20	5	2 608 690 099	63	1
2 608 587 164	31	5	2 608 596 052	28	5	2 608 597 660	21	5	2 608 690 100	63	1
2 608 587 165	31	5	2 608 596 053	28	5	2 608 597 661	21	5	2 608 690 101	61	1
2 608 587 166	31	5	2 608 596 054	28	5	2 608 597 662	21	5	2 608 690 102	61	1
2 608 587 167	31	5	2 608 596 055	28	5	2 608 597 663	21	5	2 608 690 106	67	1
2 608 587 168	31	5	2 608 596 056	28	5	2 608 597 664	21	5	2 608 690 108	67	1
2 608 587 169	31	1	2 608 596 057	28	5	2 608 597 665	21	5	2 608 690 110	68	1
2 608 587 170	31	1	2 608 596 058	28	5	2 608 597 666	21	5	2 608 690 111	68	1
2 608 587 171	34	1	2 608 596 059	28	5	2 608 597 667	21	5	2 608 690 112	68	1
2 608 587 172	34	1	2 608 596 060	28	5	2 608 597 668	21	1	2 608 690 113	68	1
2 608 587 173	34	1	2 608 596 061	28	5	2 608 597 669	21	1	2 608 690 114	68	1
2 608 587 174	35	1	2 608 596 062	28	1	2 608 597 670	21	1	2 608 690 115	67, 68	1
2 608 587 175	35	1	2 608 596 063	28	1	2 608 597 671	21	1	2 608 690 124	63	1
2 608 587 176	35	1	2 608 596 064	28	1	2 608 597 672	21	1	2 608 690 125	63	1
2 608 587 177	35	1	2 608 596 065	28	1	2 608 597 673	21	1	2 608 690 126	63	1
2 608 587 178	34	1	2 608 596 076	28	5	2 608 597 674	21	1	2 608 690 127	63	1
2 608 587 179	34	1	2 608 596 115	38	5	2 608 597 675	21	1	2 608 690 128	63	1
2 608 587 180	34	1	2 608 596 116	38	1	2 608 597 677	20	5	2 608 690 129	63	1
2 608 587 181	34	1	2 608 596 117	38	1	2 608 597 678	20	5	2 608 690 130	63	1
2 608 587 182	34	1	2 608 596 118	39	1	2 608 597 679	21	5	2 608 690 131	62	1
2 608 587 184	63	1	2 608 596 120	39	1	2 608 597 680	21	5	2 608 690 132	62	1
2 608 587 801	37	5	2 608 596 123	39	1	2 608 597 681	21	5	2 608 690 133	62	1
2 608 587 802	37	5	2 608 596 125	24	5	2 608 597 682	21	5	2 608 690 141	63	1
2 608 587 830	38	5	2 608 596 126	24	5	2 608 597 683	21	5	2 608 690 142	63	1
2 608 587 834	38	5	2 608 596 127	24	5	2 608 597 684	21	5	2 608 690 143	63	1
2 608 587 835	38	1	2 608 596 128	24	5	2 608 597 685	21	1	2 608 690 144	62	1
2 608 587 836	38	5	2 608 596 129	24	5	2 608 597 686	21	1	2 608 690 145	62	1
2 608 587 846	38	5	2 608 596 130	24	5	2 608 597 687	21	1	2 608 690 146	62	1
2 608 587 849	38	1	2 608 596 131	25	5	2 608 597 688	21	1	2 608 690 166	63	1
2 608 587 910	40	1	2 608 596 132	25	5	2 608 597 689	21	1	2 608 690 167	63	1
2 608 587 929	40	5	2 608 596 134	25	5	2 608 597 690	21	1	2 608 690 168	63	1

Part number	Page	MOQ*
2 608 690 176	62	1
2 608 690 177	62	1
2 608 690 178	62	1
2 608 690 179	64	1
2 608 690 180	62	1
2 608 690 188	65	1
2 608 690 190	65	1
2 608 690 192	65	1
2 608 690 193	65	1
2 608 690 194	65	1
2 608 690 195	65	1
2 608 690 196	65	1
2 608 690 197	65	1
2 608 690 198	63	1
2 608 690 199	63	1
2 609 390 394	61	1
2 609 390 576	61	1
F 00Y 145 188	52	1
F 00Y 145 189	52	1
F 00Y 145 190	52	1
F 00Y 145 191	52	1
F 00Y 145 192	52	1
F 00Y 145 193	52	1
F 00Y 145 194	52	1
F 00Y 145 195	52	1
F 00Y 145 196	53	1
F 00Y 145 197	53	1
F 00Y 145 198	53	1
F 00Y 145 199	53	1
F 00Y 145 200	53	1
F 00Y 145 201	53	1
F 00Y 145 202	53	1
F 00Y 145 203	54	1
F 00Y 145 204	54	5

# Date of production

or packing

## Encrypted month codes

	2005	2006	2007	2008	2009	2010	2011	2012	2013	2014	2015
<b>January</b>	581	681	781	881	981	001	101	201	301	417	517
<b>February</b>	582	682	782	882	982	002	102	202	302	418	518
<b>March</b>	583	683	783	883	983	003	103	203	303	419	519
<b>April</b>	584	684	784	884	984	004	104	204	304	420	520
<b>May</b>	585	685	785	885	985	005	105	205	305	453	553
<b>June</b>	586	686	786	886	986	006	106	206	306	454	554
<b>July</b>	587	687	787	887	987	007	107	207	307	455	555
<b>August</b>	588	688	788	888	988	008	108	208	308	456	556
<b>September</b>	589	689	789	889	989	009	109	209	309	457	557
<b>October</b>	590	690	790	890	990	010	110	210	310	458	558
<b>November</b>	591	691	791	891	991	011	111	211	311	459	559
<b>December</b>	592	692	792	892	992	012	112	212	312	460	560



# The Bosch ordering and packaging control system

The ordering and packaging control system makes it easier to order the right amount and find the packaging type at a glance.

Order quantities are rounded up to the minimum order quantity.

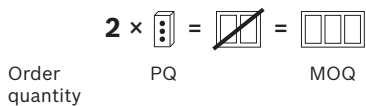

Order quantities must be a multiple of the minimum order quantity: 3, 6, 9, etc.

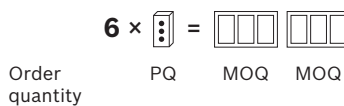

**For example:**

**Step 1:** The packaging type for each part number can be found on the product pages:

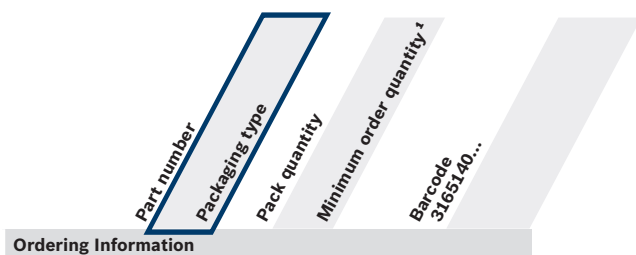

Part number	Packaging type	Pack quantity	Minimum order quantity	Barcode
2 608 585 780	P1p	1	1	511421
2 608 585 781	P1p	1	1	511438

**Step 2:** An illustration of the corresponding packaging type and specifications about the type of suspension and form of the packaging can be found on the back cover.



**P1p** Watchbox with Euro hole  
**P2p** Watchbox with other type of suspension

**Step 3:** How is a packaging type designation structured?



**1. There are six different material groups which are identified by the initial letter in the English designation:**

- Packaging made of paper, cardboard or corrugated board (**C**ardboard)
- Plastic packaging (**P**lastic)
- Combined plastic/cardboard packaging (**P**lastic and **C**ardboard)
- Metal packaging (**M**etal)
- Unpacked product (**U**npacked)
- Wood packaging (**W**ood)

**2. Each packaging has one of three different types of suspension:**

- 0** without any type of suspension
- 1** with Euro hole
- 2** other type of suspension

**3. In the six material groups, each form of packaging is identified by a lower case letter:**

**C Packaging made of paper, cardboard or corrugated board**

- a Box
- b Folded carton
- c Pocket
- d Sleeve
- e Hanger
- f Paper bag
- h Tube
- k Carton with sleeve

**P Plastic packaging**

- a Box
- b Bag
- c Pouch
- d Bag with tab card
- e Hanger
- f Shrink-wrapped
- h Tube
- k Cassette
- n Sleeve
- p Watchbox

**PC Combined plastic/cardboard packaging**

- a Blister
- b Folding blister
- c Shrink-wrapped carton
- d Tight Pack

**U Unpacked product**

No form specifications

**W Wood packaging**

- a Case



# Packaging

## that conveys clear information

Packaging made of paper, cardboard or corrugated board (**C**ardboard)



**C0a** Box without any type of suspension



**C0f** Paper bag without any type of suspension



**C0h** Tube without any type of suspension



**C2h** Tube with other type of suspension

Combined plastic/cardboard packaging (**P**lastic and **C**ardboard)

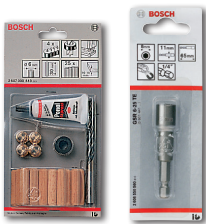

**PC1a** Blister with Euro hole



**PC1b** Folding blister with Euro hole



**PC1c** Shrink-wrapped carton with Euro hole

Unpacked product  
(**U**npacked)



**PC1d** Tight Pack with Euro hole



**U0** Without any type of suspension

## Plastic packaging (Plastic)

---



**P0a** Box without any type of suspension



**P0b** Bag without any type of suspension



**P1c** Pouch with Euro hole

**P1a** Box with Euro hole

---

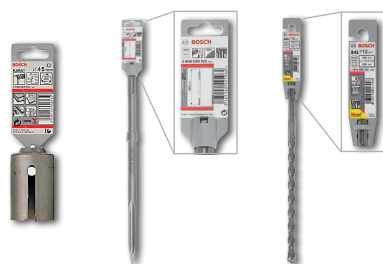

**P1e** Hanger with Euro hole



**P1f** Shrink-wrapped with Euro hole



**P1h** Tube with Euro hole

---



**P1k** Cassette with Euro hole

---