

# Product datasheet

Specifications



## inductive sensor XS4 M18 - L34mm - PPS - Sn8mm - 12..24VDC - cable 2m

Local distributor code: 22490135 XS4P18PC410

EAN Code : 3389110919516

### Main

Range of product	Telemecanique Inductive proximity sensors XS
Series name	General purpose
Sensor type	Inductive proximity sensor
Sensor name	XS4
Sensor design	Cylindrical M18
Size	34 mm
Body type	Fixed
Detector flush mounting acceptance	Non flush mountable
Material	Plastic
Type of output signal	Discrete
Wiring technique	4-wire
[Sn] nominal sensing distance	8 mm
Discrete output function	1 NO + 1 NC
Output circuit type	DC
Discrete output type	PNP
Electrical connection	Cable
Cable length	2 m
[Us] rated supply voltage	12...24 V DC with reverse polarity protection
Switching capacity in mA	<= 200 mA with overload and short-circuit protection
IP degree of protection	IP68 double insulation conforming to IEC 60529

### Complementary

Thread type	M18 x 1
Detection face	Frontal
Front material	PPS
Enclosure material	PPS
Operating zone	0...6.4 mm
Differential travel	1...15% of Sr

Cable composition	4 x 0.22 mm <sup>2</sup>
Wire insulation material	PVC
Status LED	Output state: 1 LED (yellow)
Supply voltage limits	10...36 V DC
Switching frequency	<= 2000 Hz
Maximum voltage drop	<2 V (closed)
Current consumption	0...10 mA no-load
Maximum delay first up	5 ms
Maximum delay response	0.15 ms
Maximum delay recovery	0.35 ms
Marking	CE
Threaded length	26 mm
Height	18 mm
Length	34 mm
Net weight	0.1 kg

## Environment

Product certifications	CSA UL
Ambient air temperature for operation	-25...70 °C
Ambient air temperature for storage	-40...85 °C
Vibration resistance	25 gn amplitude = +/- 2 mm (f = 10...55 Hz) conforming to IEC 60068-2-6
Shock resistance	50 gn for 11 ms conforming to IEC 60068-2-27

## Packing Units

Unit Type of Package 1	PCE
Number of Units in Package 1	1
Package 1 Height	4.1 cm
Package 1 Width	9.3 cm
Package 1 Length	14.2 cm
Package 1 Weight	78.0 g
Unit Type of Package 2	S03
Number of Units in Package 2	44
Package 2 Height	30 cm
Package 2 Width	30 cm
Package 2 Length	40 cm
Package 2 Weight	4.67 kg

## Offer Sustainability

Sustainable offer status	Green Premium product
REACH Regulation	<a href="#">REACH Declaration</a>
EU RoHS Directive	Pro-active compliance (Product out of EU RoHS legal scope) <a href="#">EU RoHS Declaration</a>

---

<b>Mercury free</b>	Yes
<b>RoHS exemption information</b>	<a href="#">Yes</a>
<b>Environmental Disclosure</b>	<a href="#">Product Environmental Profile</a>
<b>Circularity Profile</b>	<a href="#">End of Life Information</a>

---

### **Contractual warranty**

---

<b>Warranty</b>	18 months
-----------------	-----------

Dimensions

mm  
in.

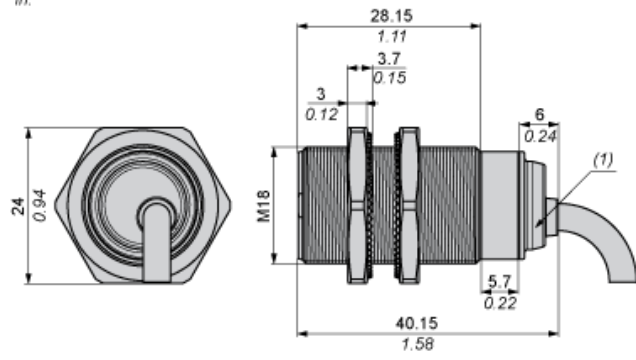

(1) LED

**Minimum Mounting Distances**

---

Side by side

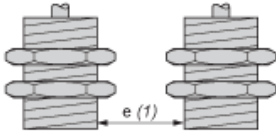

**e (1) ≥ 32 mm/1.26 in.**

Face to face

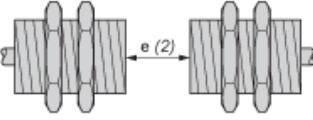

**e (2) ≥ 96 mm/3.78 in.**

Facing a metal object

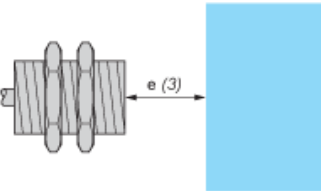

**e (3) ≥ 24 mm/0.94 in.**

Mounted in a metal support

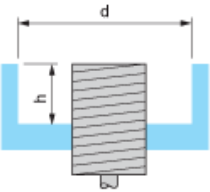

**d ≥ 56 mm/2.20 in.**

**h ≥ 16 mm/0.63 in.**

## Wiring Schemes

---

PNP 4-wire

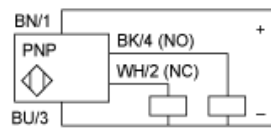

- BU :** Blue
- BN :** Brown
- BK :** Black
- WH :** White

**Performance Curves**

---

**Standard Steel Target : 24x24x1 mm**

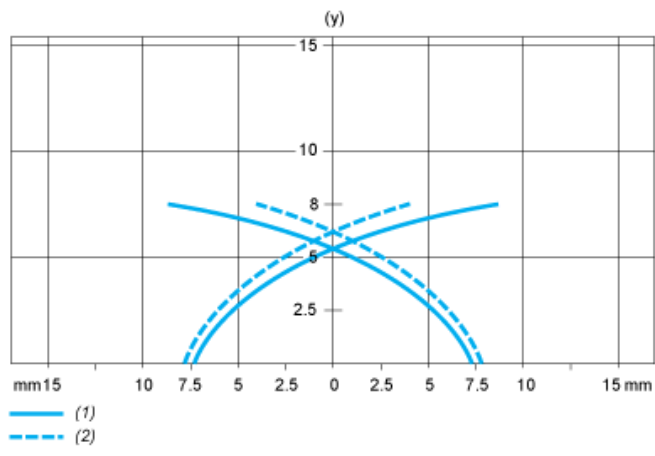

- (1) Pick-up points
- (2) Drop-out points (object approaching from the side)
- (y) Sensing distance in mm

**Recommended replacement(s)**