

Product datasheet

Specifications



inductive sensor XS5 M30 - L74mm - brass - Sn10mm - 12..48VDC - M12

Local distributor code: 387027544 XS530B1DAM12

EAN Code : 3389110145564

Main

Range of product	Telemecanique Inductive proximity sensors XS
Series name	General purpose
Sensor type	Inductive proximity sensor
Device application	-
Sensor name	XS5
Sensor design	Cylindrical M30
Size	62 mm
Body type	Fixed
Detector flush mounting acceptance	Flush mountable
Material	Metal
Type of output signal	Discrete
Wiring technique	2-wire
[Sn] nominal sensing distance	10 mm
Discrete output function	1 NO
Output circuit type	DC
Electrical connection	Male connector M12, 4 pins
[Us] rated supply voltage	12...48 V DC
Switching capacity in mA	1.5...100 mA DC with overload and short-circuit protection
IP degree of protection	IP67 conforming to IEC 60529 IP69K conforming to DIN 40050

Complementary

Thread type	M30 x 1.5
Detection face	Frontal
Front material	PPS
Enclosure material	Nickel plated brass
Operating zone	0...8 mm
Differential travel	1...15% of Sr
Status LED	Output state: 1 LED (yellow)

Supply voltage limits	10...58 V DC
Maximum residual current	0.5 mA open state
Switching frequency	<= 2000 Hz
Maximum voltage drop	<4 V (closed)
Maximum delay first up	10 ms
Maximum delay response	0.3 ms
Maximum delay recovery	0.3 ms
Marking	CE
Threaded length	52 mm
Length	74 mm
Net weight	0.145 kg

Environment

Product certifications	CCC UL CSA
Ambient air temperature for operation	-25...70 °C
Ambient air temperature for storage	-40...85 °C
Vibration resistance	25 gn amplitude = +/- 2 mm (f = 10...55 Hz) conforming to IEC 60068-2-6
Shock resistance	50 gn for 11 ms conforming to IEC 60068-2-27

Packing Units

Unit Type of Package 1	PCE
Number of Units in Package 1	1
Package 1 Height	3.4 cm
Package 1 Width	6.5 cm
Package 1 Length	15.1 cm
Package 1 Weight	132.0 g
Unit Type of Package 2	S02
Number of Units in Package 2	44
Package 2 Height	15.0 cm
Package 2 Width	30.0 cm
Package 2 Length	40.0 cm
Package 2 Weight	6.064 kg

Offer Sustainability

Sustainable offer status	Green Premium product
REACH Regulation	REACH Declaration
EU RoHS Directive	Pro-active compliance (Product out of EU RoHS legal scope) EU RoHS Declaration
Mercury free	Yes
RoHS exemption information	Yes
Environmental Disclosure	Product Environmental Profile
Circularity Profile	End of Life Information

Contractual warranty

Warranty

18 months

Dimensions

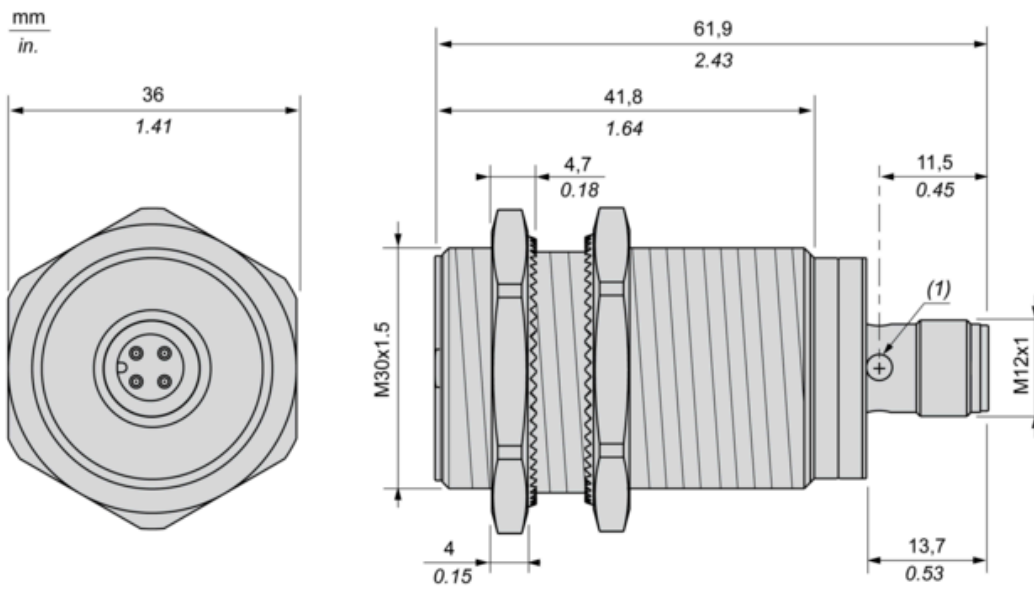

(1) : LED

Minimum Mounting Distances

Side by side

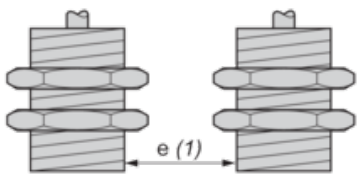

$e (1) \geq 20 \text{ mm}/0.79 \text{ in}$

Face to face

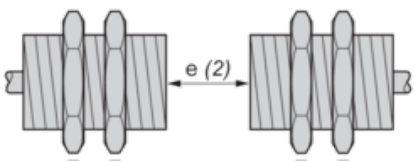

$e (2) \geq 120 \text{ mm}/4.72 \text{ in}$

Facing a metal object

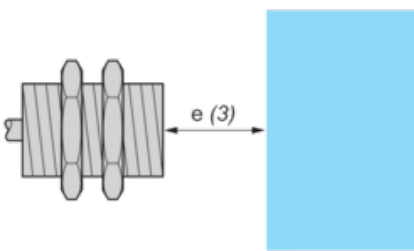

$e (3) \geq 30 \text{ mm}/1.18 \text{ in.}$

Wiring Schemes

2-Wire Non-polarised

M12 connector

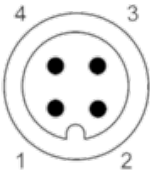

NO output

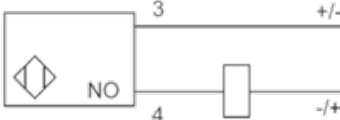

Performance Curves

Standard Steel Target : 30x30x1 mm

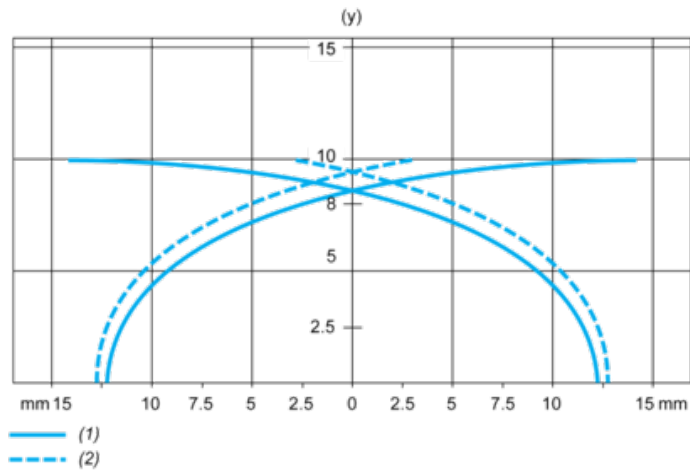

- (1) Pick-up points
- (2) Drop-out points (object approaching from the side)
- (y) Sensing distance in mm

Recommended replacement(s)