

Product datasheet

Specifications



inductive sensor XS4 M30 - L70mm - PPS - Sn15mm - 12..24VDC - M12

Local distributor code: 386330203 XS4P30KP340D

EAN Code : 3389110518757

Main

Range of product	Telemecanique Inductive proximity sensors XS
Series name	General purpose
Sensor type	Inductive proximity sensor
Sensor name	XS4
Sensor design	Cylindrical M30
Size	70 mm
Body type	Fixed
Detector flush mounting acceptance	Non flush mountable
Material	Plastic
Type of output signal	Discrete
Wiring technique	4-wire
[Sn] nominal sensing distance	15 mm
Discrete output function	1 NO or 1 NC programmable
Output circuit type	DC
Discrete output type	PNP and NPN
Electrical connection	Male connector M12, 4 pins
[Us] rated supply voltage	12...24 V DC with reverse polarity protection
Switching capacity in mA	<= 200 mA with overload and short-circuit protection
IP degree of protection	IP67 conforming to IEC 60529

Complementary

Thread type	M30 x 1.5
Detection face	Frontal
Front material	PPS
Enclosure material	PPS
Operating zone	0...12 mm
Differential travel	1...15% of Sr
Status LED	Output state: 1 LED (yellow)

Supply voltage limits	10...36 V DC
Switching frequency	<= 1000 Hz
Maximum voltage drop	<2.6 V (closed)
Current consumption	0...10 mA no-load
Maximum delay first up	5 ms
Maximum delay response	0.3 ms
Maximum delay recovery	0.7 ms
Marking	CE
Threaded length	51 mm
Height	30 mm
Length	70 mm
Net weight	0.145 kg

Environment

Product certifications	UL CSA
Ambient air temperature for operation	-25...70 °C
Ambient air temperature for storage	-40...85 °C
Vibration resistance	25 gn amplitude = +/- 2 mm (f = 10...55 Hz) conforming to IEC 60068-2-6
Shock resistance	50 gn for 11 ms conforming to IEC 60068-2-27

Packing Units

Unit Type of Package 1	PCE
Number of Units in Package 1	1
Package 1 Height	3.7 cm
Package 1 Width	9.5 cm
Package 1 Length	10.1 cm
Package 1 Weight	76.0 g
Unit Type of Package 2	S01
Number of Units in Package 2	12
Package 2 Height	15 cm
Package 2 Width	15 cm
Package 2 Length	40 cm
Package 2 Weight	1.095 kg

Offer Sustainability

Sustainable offer status	Green Premium product
REACH Regulation	REACH Declaration
EU RoHS Directive	Pro-active compliance (Product out of EU RoHS legal scope) EU RoHS Declaration
Mercury free	Yes
RoHS exemption information	Yes
Environmental Disclosure	Product Environmental Profile

Contractual warranty

Warranty 18 months

Dimensions

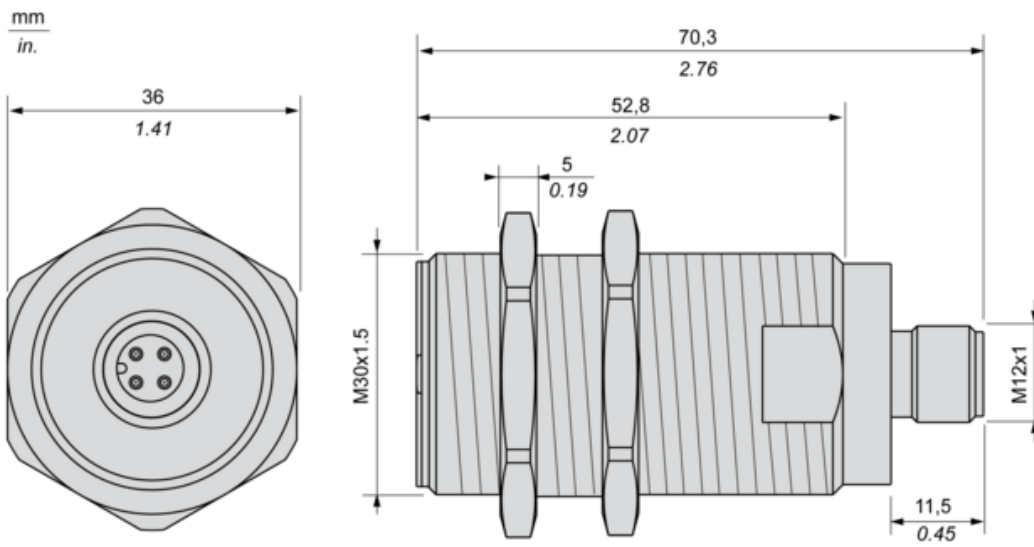

Minimum Mounting Distances

Side by side



$e (1) \geq 60 \text{ mm} / 2.36 \text{ in.}$

Face to face

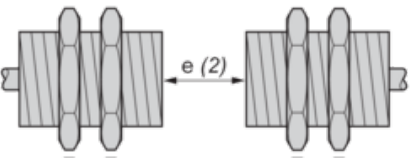

$e (2) \geq 180 \text{ mm} / 7.09 \text{ in.}$

Facing a metal object

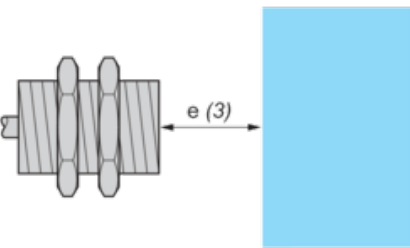

$e (3) \geq 45 \text{ mm} / 1.77 \text{ in.}$

Mounted in a metal support

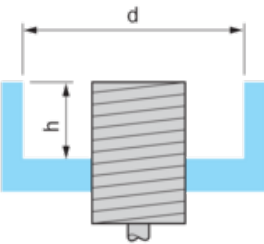

$d \geq 90 \text{ mm} / 3.54 \text{ in.}$

$h \geq 30 \text{ mm} / 1.18 \text{ in.}$

Wiring Schemes

M12 Connector

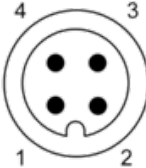

4-Wire DC, PNP/NPN, NO or NC output

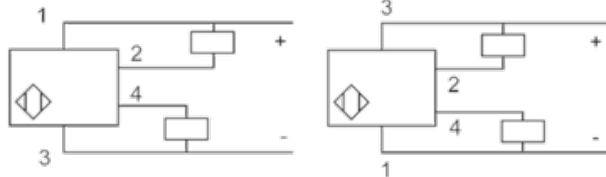

Performance Curves

Standard Steel Target : 45x45x1 mm

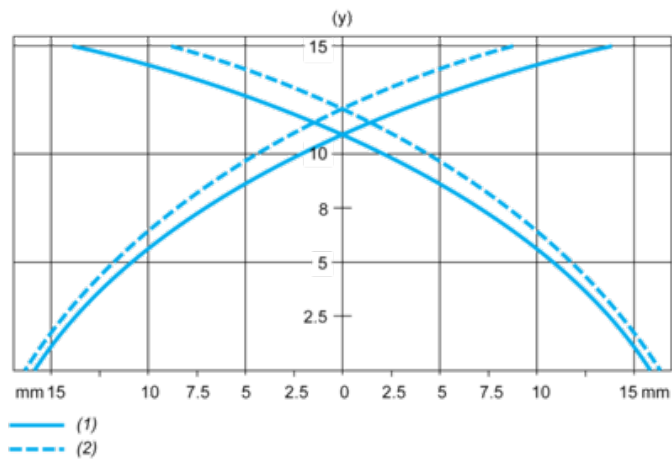

- (1) Pick-up points
- (2) Drop-out points (object approaching from the side)
- (y) Sensing distance in mm

Recommended replacement(s)