

Product datasheet

Specifications



inductive sensor XS5 M12 - L35mm
- brass - Sn2mm - 12..24VDC -
cable 2m

Local distributor code: 387012630 XS512B1PBL2

EAN Code : 3389110143768

Main

| | |
|------------------------------------|---|
| Range of product | Telemecanique Inductive proximity sensors XS |
| Series name | General purpose |
| Sensor type | Inductive proximity sensor |
| Device application | - |
| Sensor name | XS5 |
| Sensor design | Cylindrical M12 |
| Size | 37 mm |
| Body type | Fixed |
| Detector flush mounting acceptance | Flush mountable |
| Material | Metal |
| Type of output signal | Discrete |
| Wiring technique | 3-wire |
| [Sn] nominal sensing distance | 2 mm |
| Discrete output function | 1 NC |
| Output circuit type | DC |
| Discrete output type | PNP |
| Electrical connection | Cable |
| Cable length | 2 m |
| [Us] rated supply voltage | 12...24 V DC with reverse polarity protection |
| Switching capacity in mA | <= 200 mA DC with overload and short-circuit protection |
| IP degree of protection | IP68 double insulation conforming to IEC 60529 IP69K conforming to DIN 40050 |

Complementary

| | |
|--------------------|---------------------|
| Thread type | M12 x 1 |
| Detection face | Frontal |
| Front material | PPS |
| Enclosure material | Nickel plated brass |
| Operating zone | 0...1.6 mm |

| | |
|--------------------------|------------------------------|
| Differential travel | 1...15% of Sr |
| Cable composition | 3 x 0.34 mm ² |
| Wire insulation material | PVC |
| Status LED | Output state: 1 LED (yellow) |
| Supply voltage limits | 10...36 V DC |
| Switching frequency | <= 5000 Hz |
| Maximum voltage drop | <2 V (closed) |
| Current consumption | <= 10 mA no-load |
| Maximum delay first up | 10 ms |
| Maximum delay response | 0.1 ms |
| Maximum delay recovery | 0.1 ms |
| Marking | CE |
| Threaded length | 25 mm |
| Length | 35 mm |
| Net weight | 0.075 kg |

Environment

| | |
|---------------------------------------|---|
| Product certifications | UL CSA |
| Ambient air temperature for operation | -25...70 °C |
| Ambient air temperature for storage | -40...85 °C |
| Vibration resistance | 25 gn amplitude = +/- 2 mm (f = 10...55 Hz) conforming to IEC 60068-2-6 |
| Shock resistance | 50 gn for 11 ms conforming to IEC 60068-2-27 |

Packing Units

| | |
|------------------------------|----------|
| Unit Type of Package 1 | PCE |
| Number of Units in Package 1 | 1 |
| Package 1 Height | 4.2 cm |
| Package 1 Width | 9.7 cm |
| Package 1 Length | 13.2 cm |
| Package 1 Weight | 74.0 g |
| Unit Type of Package 2 | S03 |
| Number of Units in Package 2 | 44 |
| Package 2 Height | 30 cm |
| Package 2 Width | 30 cm |
| Package 2 Length | 40 cm |
| Package 2 Weight | 4.665 kg |

Offer Sustainability

| | |
|--------------------------|---|
| Sustainable offer status | Green Premium product |
| REACH Regulation | REACH Declaration |
| EU RoHS Directive | Pro-active compliance (Product out of EU RoHS legal scope) EU RoHS Declaration |

| | |
|-----------------------------------|---|
| Mercury free | Yes |
| RoHS exemption information | Yes |
| Environmental Disclosure | Product Environmental Profile |
| Circularity Profile | End of Life Information |

Contractual warranty

| | |
|-----------------|-----------|
| Warranty | 18 months |
|-----------------|-----------|

Dimensions

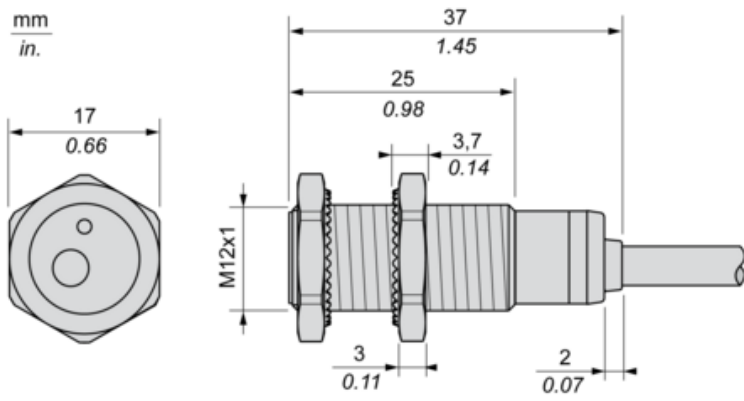

Minimum Mounting Distances

Side by side

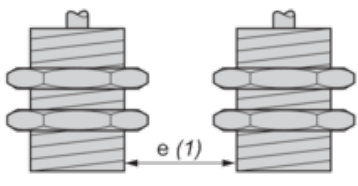

$e (1) \geq 4 \text{ mm}/0.16 \text{ in.}$

Face to face

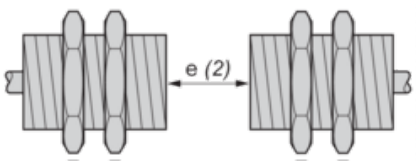

$e (2) \geq 24 \text{ mm}/0.94 \text{ in.}$

Facing a metal object

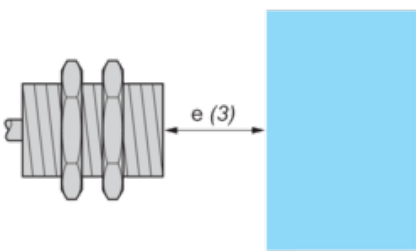

$e (3) \geq 6 \text{ mm}/0.24 \text{ in.}$

Mounting

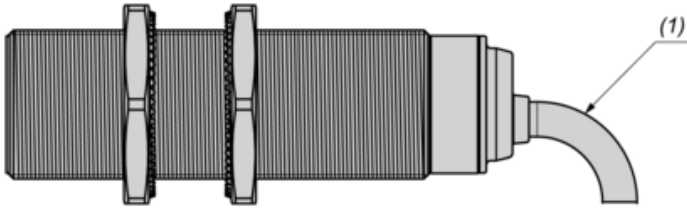

(1) Bending cable: 4 x external cable diameter

Wiring Schemes

PNP

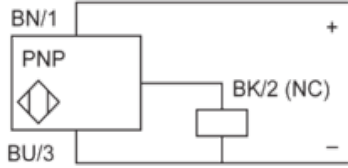

- BU** : Blue
- BN** : Brown
- BK** : Black

Performance Curves

Standard Steel Target : 12x12x1 mm

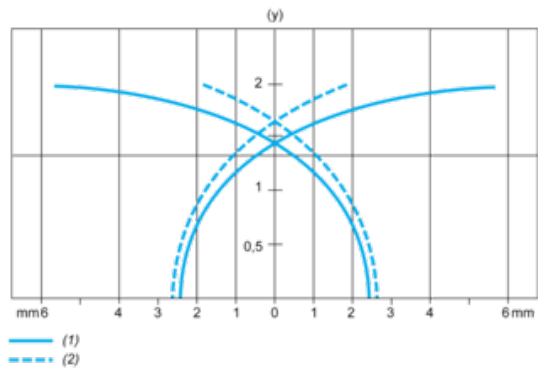

- (1) Pick-up points
- (2) Drop-out points (object approaching from the side)
- (y) Sensing distance in mm

Recommended replacement(s)