

DATASHEET

COUGAR

Cougar 200W LED IP65 Asymmetric Floodlight 740

Energy Efficiency Classification Class E
 High Quality Die Cast Aluminium Construction
 Toughened Glass Front Panel



GENERAL INFORMATION	
Product Code	NCU200/740
Product Range	Floodlighting
Product Category	Floodlighting
IP Rating	65
IK Rating	IK08
Warranty	5 Years Unlimited
DIMENSION/WEIGHT	
Dimensions Circular (DIA x H) (mm)	DIA=N/A, H=N/A
Dimensions Square/Rectangular (L x W x H) (mm)	L=346, W=68, H=532
Cut-out Size (mm)	N/A
Product Weight (Kg)	9.1
CONSTRUCTION	
Body Material	Die Cast Aluminium
Body Colour	Black
Optical Material	N/A
Optical Finish	N/A
Termination	0.7m H05RN-F Flex
Driver - Integal or Remote	Integral
PACKAGING	
Carton Dimensions (mm)	N/A
Quantity per Outer Carton	N/A
Total Weight incl. Carton (Kg)	N/A

LUMINAIRE PERFORMANCE	
Energy Rating	E
Luminaire Lumens (lm)	23050
Power Consumption (W)	200
LED Lumens (lm/W)	175
Efficacy (l.lm/c.W)	115
Operating Temp. (Min/Max)	-20°C to 25°C
LIGHT SOURCE	
Type	LED
Correlated Colour Temp.	4000
Colour Rendering Index (CRI)	>70
Lumen Depreciation	L70 50000
SDCM	<5
ELECTRICAL INPUT	
VOLTAGE (V)	220-240V AC
Operating Frequency	50
In Rush	60A @510us
Drivers per MCB*	B16=4 C16=6
Class	Class 1
Power Factor	>0.95
Cable Entry	Prewired
ELECTRICAL OUTPUT	
Forward Current (mA)	N/A
Forward Voltage (Vf)	N/A
EMERGENCY DATA	
Mode of Operation	N/A
Battery Duration	N/A
Battery Type	N/A
Battery Specification	N/A
Ballast Lumen Factor (BLF)	N/A
DIMMING	
DALI	N/A
OTHER	N/A
Switch Dim	N/A
Corridor Function	N/A
SENSORS	
Microwave	N/A
PIR	N/A
STANDARDS/APPROVALS	
CE Marked	Yes
Certificate of Conformity	Yes
Accreditations	N/A
BARCODE	
EAN NUMBER	5055943068384

* GUIDE ONLY

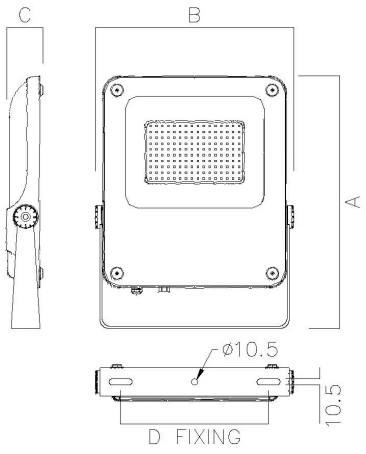

SIZE	A	B	C	D
50W	358	250	60	120-180
100W	408	281	60	142-202
150W	442	346	64	180-260
200W	532	346	68	180-260

