

**Standard Dimensions:**

The following are standard dimensions unless otherwise stated.

All dimensions subject to commercial tolerance.

- Hole Size: 14mm diameter
- Hole Spacing (From End): 20mm from end of fitting
- Hole spacing (On Center): 48mm center to center
- Fitting Width: 40mm

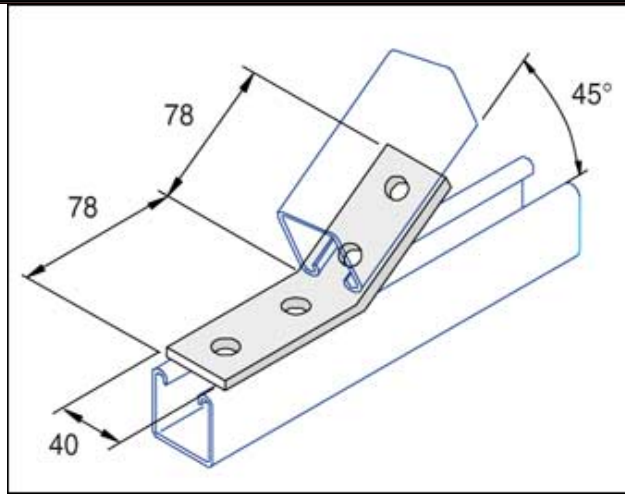

Part No.	Finish	Weight	Box Qty
P1074	HG	0.25	25
P1074	SS	0.21	25

**Project:** \_\_\_\_\_

**Approval Stamp:**

**Architect / Engineer:** \_\_\_\_\_

**Date:** \_\_\_\_\_ **Phone:** \_\_\_\_\_

**Contractor:** \_\_\_\_\_

**Address:** \_\_\_\_\_

**Notes 1:** \_\_\_\_\_

\_\_\_\_\_