



INSTALL RANGE

QVIS

LED LIGHTING

QVIS Lighting, now approaching its seventh year as a recognised luminaire manufacturer, continues to grow through innovation, depth of range and customer loyalty. As well as being a member of the Lighting Industry Association (LIA), The Manufacturers' Organisation (MAKE) and Philips EnabLED Licencing Program, QVIS is also an ISO 9001:2015 registered company. Through its high level of service and support, the QVIS brand installs trust in the competence to design, supply and service for the life of the project, well beyond its install. A focus on specification and value engineering ensures QVIS offers lighting solutions across all major sectors with minimal lead time and equal or superior product specifications.

Fully equipped with the latest in LED technology, QVIS is established as an affordable brand that doesn't compromise on quality and performance. QVIS is committed to incorporating reputable component manufacturers who guarantee long life and serviceability on their product lines.

Sustainability is important to QVIS, as it is for our customers. We focus on ensuring energy efficiency across our range of fully integrated LED luminaires, which have a proven record of high performance and longevity. Suitable across a wide range of sectors, including but not limited to; commercial, health, industrial, retail and education sector, we offer the flexibility of interchanging drivers on request. With conventional 1-10V, Switch Dim and DALI options, along with the latest in Bluetooth and Wireless communication, QVIS offer dimmable solutions for lighting control requirements, assisting in energy saving, building sustainability performance and in turn, a reduction in carbon footprint.

In order to further enhance its growing reputation and brand recognition within the UK, QVIS has acquired lighting specialists from some of the biggest manufacturers in Europe and partnered with market leading component and solution providers. Utilising their wealth of knowledge and expertise in design, supply and implementation, QVIS gain a full understanding of their customer's project needs and requirements.

In 2019, ADATA companies; QVIS lighting and OYN-X merged to offer our wholesale partners both lighting and security. It is not only the synergy of these companies that led to the merge, but also the enhanced customer service and offering that would ensue. With a range of premium Security and CCTV products now added to the range, the exceptional quality and reliability that QVIS customers have experienced now extends beyond lighting.

The QVIS customer base and market coverage has grown exponentially and continues on this trajectory, while investment in an ever expanding product range and sales support will continue to give QVIS Lighting and Security customers peace of mind.

ACCREDITATION



OUR SUPPLIERS

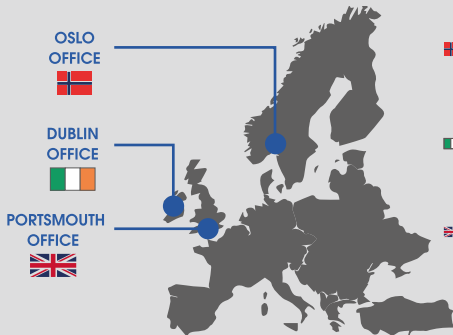

Phone: +47 40178640
Email: bjorn@qvislighting.com

Phone: +353(0)8726 97494
Email: andy@qvis.ie

Phone: +44(0)2393 870050
Email: sales@qvislighting.com



🇮🇪 Dublin showroom - New for 2020

CONTENTS*

SURFACE/SUSPENDED

DOWNLIGHTS



PAGE 3



PAGE 5

MODULAR PANELS



PAGE 7



PAGE 9



PAGE 11

*Luminaires shown within the Install range are stocked in volume at our Hampshire HQ. We pride ourselves on the ability to turn full project quantities around with very short lead times, although please note that our stock is subject to availability

Taurus

TRI-COLOUR SURFACE BULKHEAD



SCREWLESS
DESIGN



TRI
COLOUR



RAISED
MOUNT PLATE



CRI



TAU-16-325TC

16W
POWER

1680
LUMENS

EPISTAR

LEDs inside

LIFUD

Driver as standard

IP54

SPECIFICATIONS

4

Taurus



| Model | Wattage | Colour Temp | Power Factor | Weight | Dimensions |
|--------------|---------|--------------|--------------|--------|----------------|
| TAU-16-325TC | 16W | CCT 3K/4K/6K | >0.9 | 0.89kg | ∅325mm x 109mm |

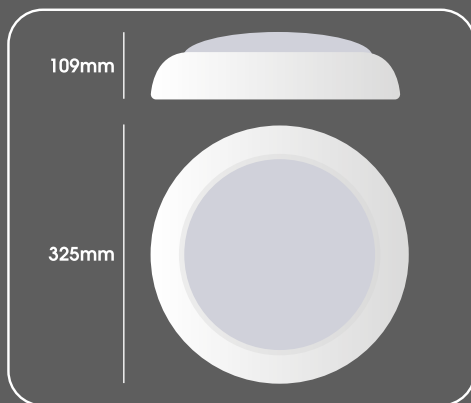
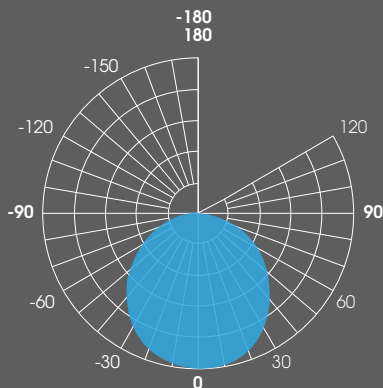

OPTIONS

**INTEGRAL
EMERGENCY**



LEAD TIME

DIMMING



LEAD TIME

**MICROWAVE
SENSOR**



LEAD TIME

VIRGO

TRI-COLOUR & DUAL POWER DOWNLIGHT



TRI
COLOUR



DUAL
POWER



POLYCARBONATE
HOUSING



OPAL
DIFFUSER



VGO- /

8W/12W
POWER

12W/18W
POWER

18W/25W
POWER

520-840
LUMENS

840-1350
LUMENS

1350-2000
LUMENS

/8/12-
80/160TC

/12/18-
120/200TC

/18/25-
150/270TC

EPISTAR **Q-DRIVE**

LEDs inside

Driver as standard

IP44

SPECIFICATIONS

6

VIRGO



| Model | Wattage | Colour Temp | Power Factor | Weight | Dimensions |
|---------------------|---------|--------------|--------------|--------|-----------------|
| VGO-8/12-80/160TC | 8W/12W | CCT 3K/4K/6K | >0.85 | 0.4kg | ∅180mm x 20.5mm |
| VGO-12/18-120/200TC | 12W/18W | CCT 3K/4K/6K | >0.9 | 0.53kg | ∅220mm x 21.5mm |
| VGO-18/25-150/270TC | 18W/25W | CCT 3K/4K/6K | >0.9 | 0.95kg | ∅300mm x 25mm |

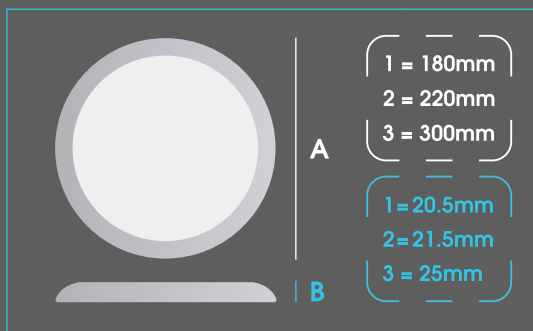
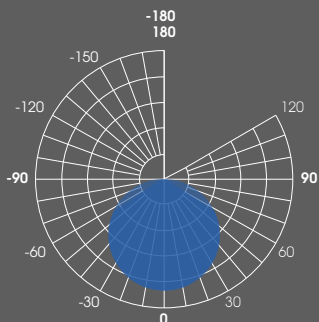

Need something more bespoke for your project?

No problem! Take a look at our 'Concept Range' catalogue, available to view at www.qvisled.com/downloads

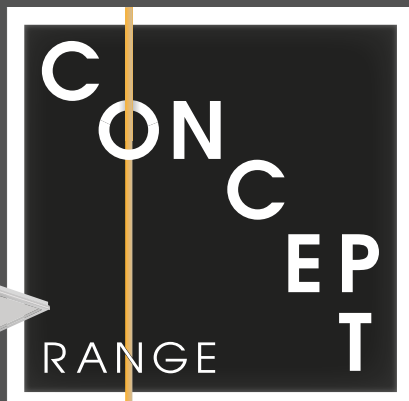



OYN-X

EDGE-LIT MODULAR PANEL



RATED



BEAM ANGLE



LOW UGR



CRI

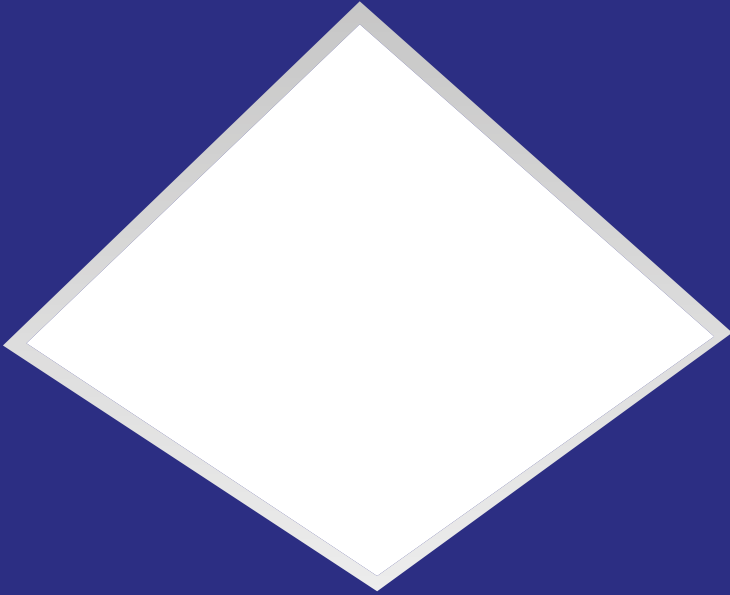

OX-PRO-34-6X6YY*

34W
POWER

3570
LUMENS

*YY is for colour temperature
NW = 4000K (Neutral White)
WW = 6000K (Cool White)

EPISTAR Q-DRIVE

LEDs inside

Driver as standard



IP44

SPECIFICATIONS

8

OYN-X

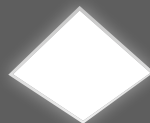

| Model | Wattage | Colour Temp | Power Factor | Weight | Dimensions |
|-----------------|---------|----------------|--------------|--------|------------------------|
| OX-PRO-34-6X6YY | 34W | 4000K or 6000K | 0.95 | 2.5kg | 595mm x 595mm x 10.5mm |

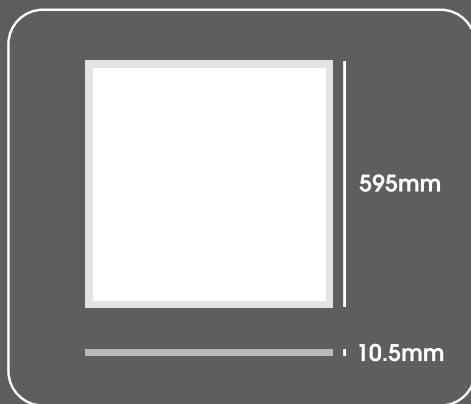
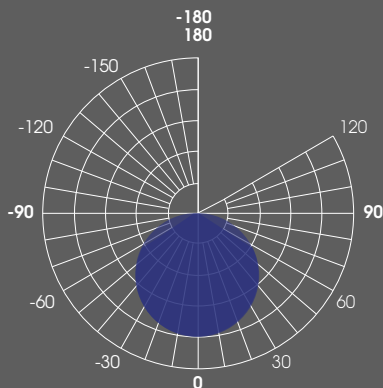

OPTIONS

**INTEGRAL
EMERGENCY**



LEAD TIME

VARIOUS DIMMING OPTIONS



SWITCH DIM



CORRIDOR



PHASE DIM



IOT

LEAD TIME



OYN-X

BACK-LIT MODULAR PANEL



RATED



BEAM ANGLE



LOW UGR



CRI

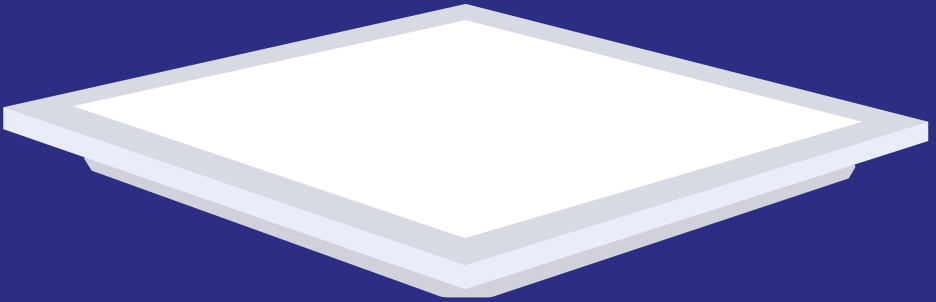

OX-BL-35-6X6NW*

35W
POWER

3675
LUMENS

*Add /LG to the model
for a microprismatic diffuser
(diffuser is otherwise opal)

EPISTAR PHILIPS

LEDs inside

Driver as standard



IP44

SPECIFICATIONS

10

OYN-X

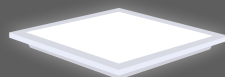

| Model | Wattage | Colour Temp | Power Factor | Weight | Dimensions |
|-------------------|---------|-------------|--------------|--------|----------------------|
| OX-BL-35-6X6NW | 35W | 4000K | 0.95 | 2.5kg | 595mm x 595mm x 32mm |
| OX-BL-35-6X6NW/LG | 35W | 4000K | 0.95 | 2.5kg | 595mm x 595mm x 32mm |

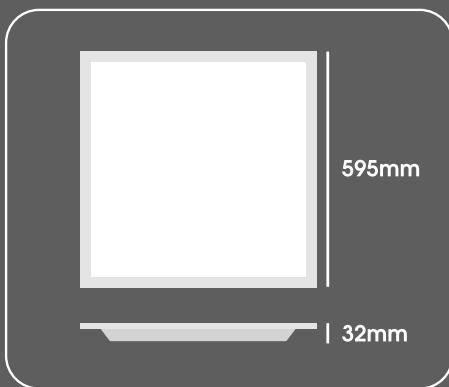
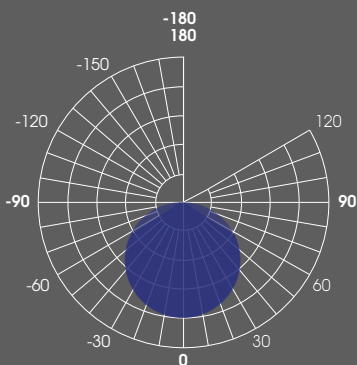

OPTIONS

**INTEGRAL
EMERGENCY**



LEAD TIME

VARIOUS DIMMING OPTIONS



SWITCH DIM



CORRIDOR



PHASE DIM



IOT

LEAD TIME

PHOENIX

WING REFLECTOR MODULAR PANEL



LED
ARRAY



OPAL
DIFFUSER



LOW UGR



CRI

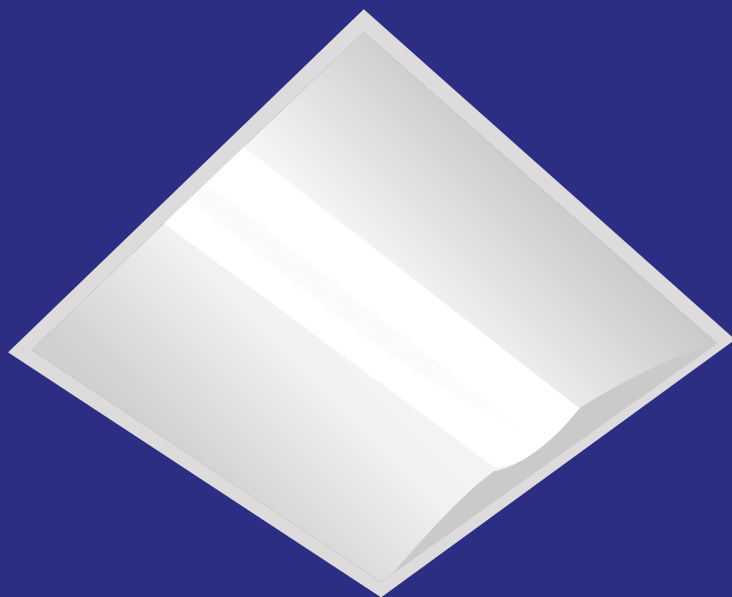

PHO-30-6X6NW

30W
POWER

3780
LUMENS

EPISTAR **TRIDONIC**

LEDs inside

Driver as standard

IP40

SPECIFICATIONS

12

PHOENIX

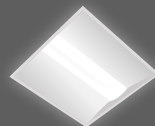

| Model | Wattage | Colour Temp | Power Factor | Weight | Dimensions |
|--------------|---------|-------------|--------------|--------|----------------------|
| PHO-30-6X6NW | 30W | 4000K | 0.95 | 2.5kg | 595mm x 595mm x 72mm |

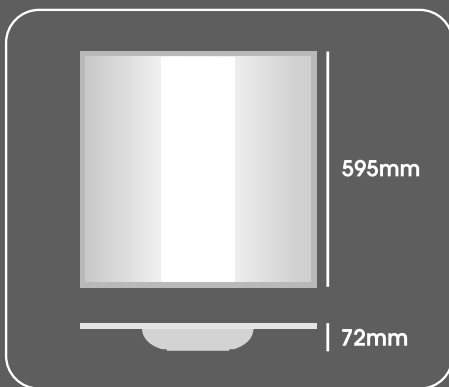
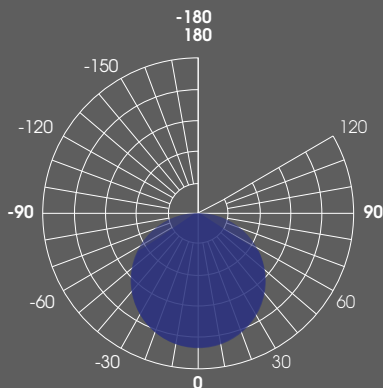

OPTIONS

**INTEGRAL
EMERGENCY**



LEAD TIME

DIMMING



LEAD TIME

ALTERNATIVES

**20W-40W
MODELS**

Request any wattage within this range - This is on a basis of 5W increments

6000K colour temperature model available from factory

LEAD TIME

For more information, visit the
Qvis LED website!

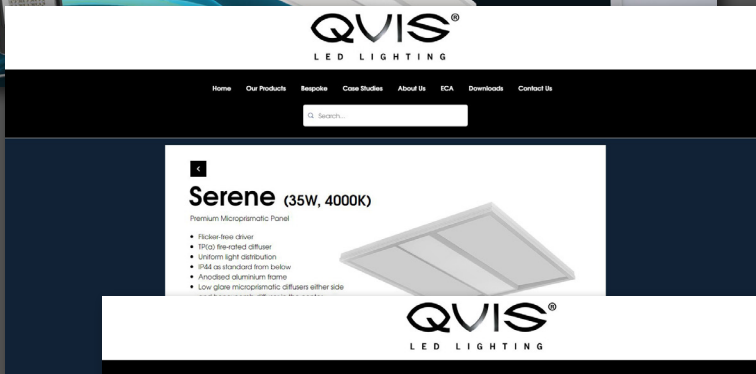

Find us at www.qvisled.com

See our full product range in our latest LED catalogue, updated for 2020!

GLOW UFO HIGH BAY

EXPLODED DRAWING OF UFO HIGHBAY

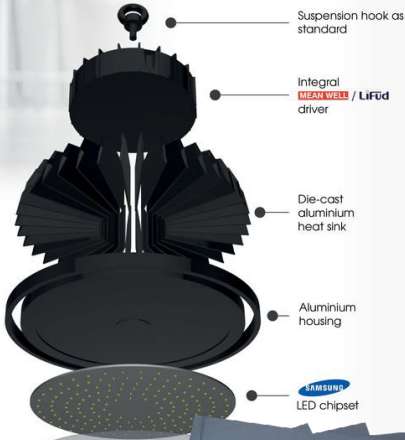

Suspension hook as standard

Integral **MEAN WELL** / **LifUD** driver

Die-cast aluminium heat sink

Aluminium housing

SAMSUNG LED chipset

GLOW UFO HIGH BAY



BUILD

- Aluminium heat-sink
- Low glare optic
- High performance efficacy, 130lm/w
- 120° beam angle as standard (reflectors available)
- Suspension hook as standard (surface bracket available)

OPTIONS

- Dimmable (1-10v as standard, DALI from factory)
- Integral emergency option
- Photocell and microwave sensor available
- Flood & agriculture diffuser available (polycarbonate)

SAMSUNG **LifUD**
LED chipsets
Driver as standard

UFO HIGH BAY

Higher wattages available from factory

| Dimensions | 100mm | 150mm | 200mm | 300mm |
|------------------------|---------------------|---------------------|---------------------|---------------------|
| System Power | 100W | 150W | 200W | 300W |
| LED Chipset | Samung | Samung | Samung | Samung |
| Driver Manufacturer | MEAN | MEAN | MEAN | MEAN |
| Colour Rendering Index | >85 | >85 | >85 | >85 |
| Lumen Output | 10000lm | 15000lm | 20000lm | 30000lm |
| LED Efficacy | 130lm/w | 130lm/w | 130lm/w | 130lm/w |
| Beamable | 1.30v | 1.30v | 1.10v | 1.10v |
| Power Factor | >0.9 | >0.9 | >0.9 | >0.9 |
| IP Rating | IP65 | IP65 | IP65 | IP65 |
| Beam Spread | 120° | 120° | 120° | 120° |
| Case Temperature | 4000x1000K | 4000x1000K | 4000x1000K | 4000x1000K |
| Housing/Material | Aluminium | Aluminium | Aluminium | Aluminium |
| Diffuser Material | Tempered Glass | Tempered Glass | Tempered Glass | Tempered Glass |
| Operating Temperature | -20 to +45°C | -20 to +45°C | -20 to +45°C | -20 to +45°C |
| IP Rating | IP65 | IP65 | IP65 | IP65 |
| AC 200-240V 47-63Hz | AC 200-240V 47-63Hz | AC 200-240V 47-63Hz | AC 200-240V 47-63Hz | AC 200-240V 47-63Hz |
| 3.3kg | 3.8kg | 4.1kg | 4.8kg | 5.3kg |
| 1000mm x 160mm | 1000mm x 160mm | 1000mm x 160mm | 1000mm x 160mm | 1000mm x 160mm |

ADD /EM FOR EMERGENCY

May: W = 16h in DTM for 4000K & CW for 6000K

DIMMING OPTIONS



03 870 050 Email: sales@qvislighting.com Visit our website: www.qvisled.com
Change without notice.



Scan to view!

<https://www.paperturn-view.com/uk/qvis-lighting-security/qvis-led-brochure-2020-interactive?pid=NzY76154&v=7>



CONTACT YOUR LOCAL REP

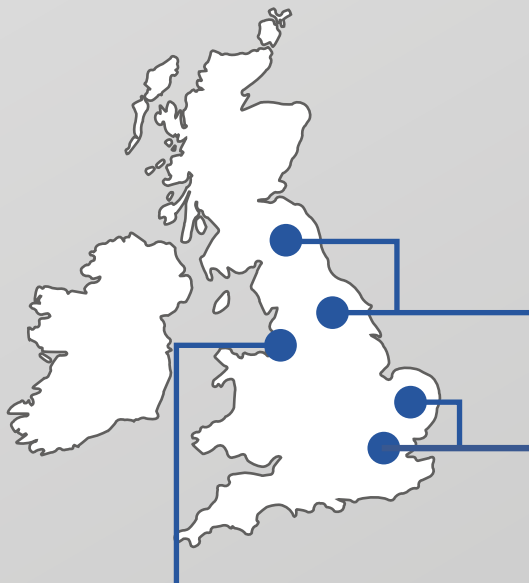

Nick (NORTH & MIDLANDS)

📞 07741163721

Roxanne (E. ANGLIA & LONDON)

📞 07741163917

Eva (MANCHESTER)

📞 07741163914

QVIS
LED LIGHTING

Affordability Without Compromise

ADDRESS:

Qvis HQ, 36 New Lane, Havant, Hampshire, PO9 2JL

OPENING TIMES:

Monday to Friday - 8.00am to 5.30pm GMT

CONTACT US:

Call: +44 (0) 2393 870 050 Email: sales@qvislighting.com Website: www.qvisled.com