

TECHNICAL DATASHEET

ADRCV1230TD
30W 12V DC CONSTANT VOLTAGE TRIAC DIMMABLE



PRODUCT FEATURES

- Constant Voltage LED Power Supply
- Moulded Polycarbonate Body
- Overload Protection
- Regulated Output
- Thermal Cutout
- SELV Rated
- Triac Dimmable

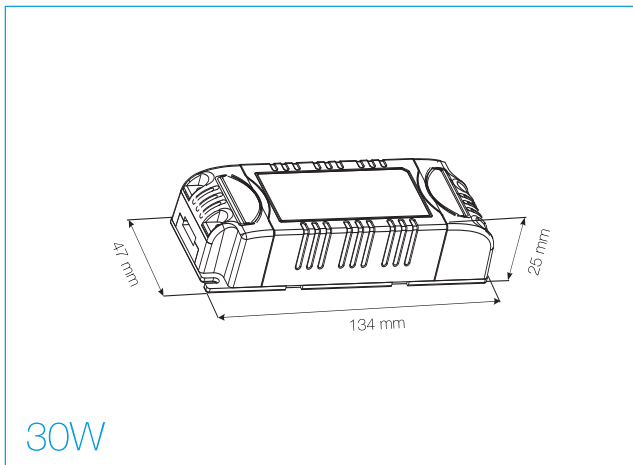

MAINS
DIMMABLE

		ErP Compliant	
	3 Year Guarantee	12V	

PRODUCT CODE	ADRCV1230TD
Operating Voltage	180-240 V AC
Output Voltage	12V DC
Operating Load	20-30W
Output Current (Max.)	2.5A
Temperature	-30~+45°C