

JCC Emergency Remote Pack

3 hour maintained LED emergency lighting pack



WARNINGS AND CAUTIONS

- To be installed in accordance with the local current wiring regulations and standards
- To avoid electric shock, serious injury or property damage, isolate power before installing, removing or servicing the product
- It is recommended that this product is installed by an electrician or a competent person with sufficient experience to install this product
- Any broken or damaged parts should be replaced as soon as possible. JCC will not accept responsibility for claims arising from sub-standard installations; which will void the warranty
- Emergency product routine inspection and tests must be undertaken at times of least risk and in accordance with EN 50172:2004. A copy of this report must accompany any fitting returned to the JCC for any reason

INSTALLATION INSTRUCTIONS

ENGLISH

- Read instructions and check that you have all of the tools and accessories required to complete the installation correctly. Isolate power supply before starting the installation.

1. Wire the emergency remote pack to the mains supply as indicated in figure 1. If a dimmable variant, connect the dimming control wires (DALI/1-10V/DSI) as shown in the product instruction sheet

2. Connect the two core cable from the remote pack into the mains input terminals of the driver (not supplied) as shown in figure 2.

3. Connect the driver low voltage output from the driver to the remote pack as shown in figure 3.

4. Connect the low voltage output from the inverter to the luminaire (not supplied) as shown in figure 4.

5. Connect batteries to the remote pack prior to completing the installation.

6. Ensure the green LED charge indicator is located alongside the luminaire and is visible once the fitting is installed and operational. Reconnect mains power supply and test for operation. (Allow 24hrs for batteries to charge before testing).

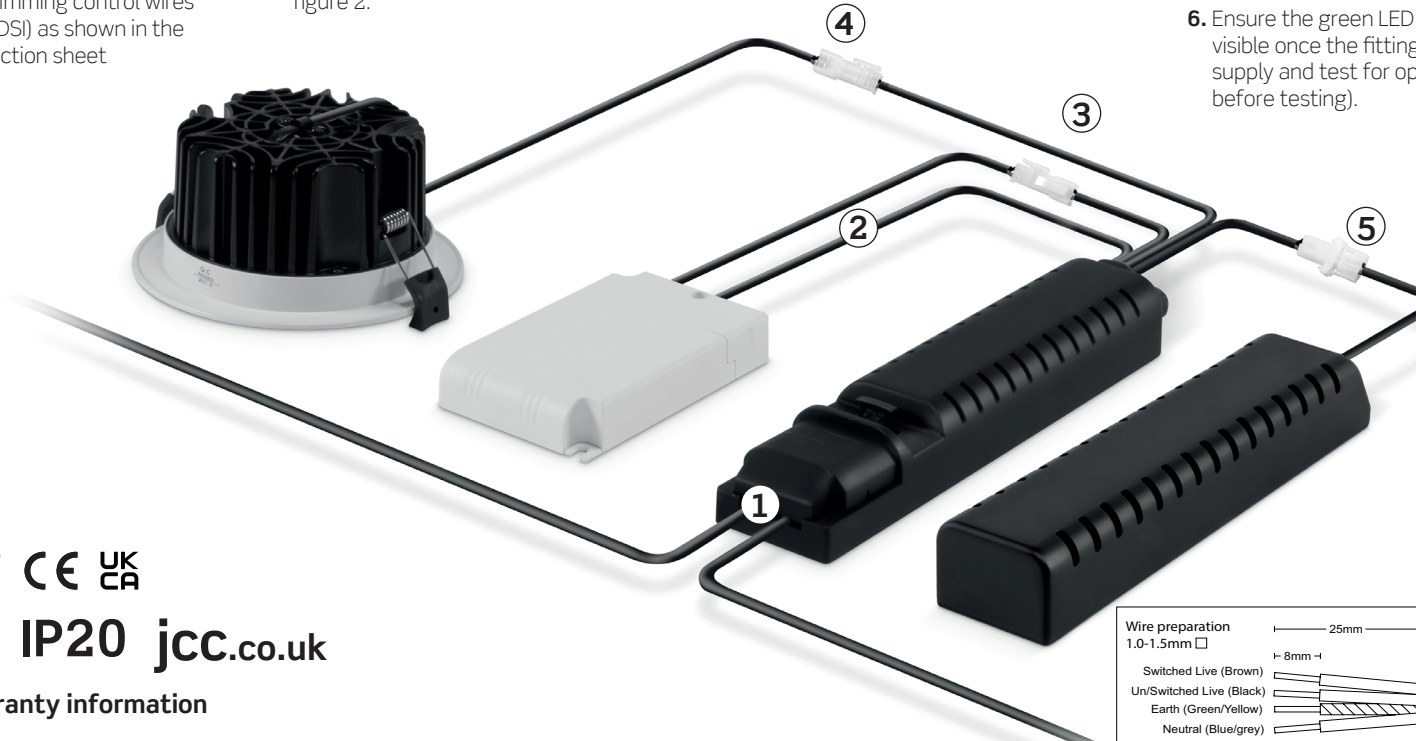

Electrical Input connection

100-240V~ 50/60Hz ±1Hz
(6-80VDC 50W max output)
Class II  with earth provision

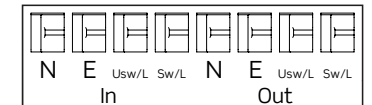

Loop in/Loop out connections

LV connection from Inverter to Luminaire

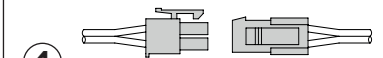

LV connection from LED Driver to Inverter

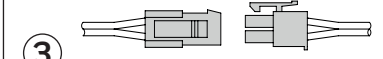

Mains supply from Inverter to LED Driver

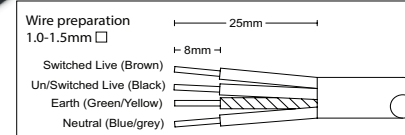
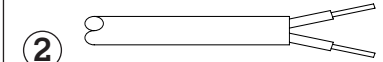

   IP20 jcc.co.uk

Important warranty information

This product is supported by a 2-year standard warranty which will extend to 3 years if registered within the first year of purchase. (2 year on batteries). Please register at jcc.co.uk/warranty - Terms and conditions apply.

The installer will be asked to provide the following information, which is detailed on a label attached to the product's chassis:
Product Code/Date Code.

Emergency range routine inspection and test

All tests must be undertaken at times of least risk and in accordance with EN 50172:2004 as indicated below:

Daily: Indicators of the emergency remote pack should be visually inspected for correct operation.

Monthly: (in addition to the daily check) If automatic testing devices are used, the results of the short duration tests shall be recorded. Test shall be carried out as follows:

Switch the luminaire over to emergency mode to operate from the batteries by simulating a failure of supply to the normal lighting, for a period sufficient to ensure correct luminaire operation.

NOTE: The period of simulation failure should be sufficient for the purpose of this clause whilst minimising damage to the system components e.g lamps. During this period, all luminaires and signs shall be checked to ensure that they are present, clean and functioning correctly. At the end of this test period, the supply to the normal lighting should be restored and any indicator lamp or device should be checked to ensure that is showing that the normal supply has been restored.

Annually: If automatic testing devices are used, the results of the short duration tests shall be recorded. For all other systems the monthly inspection shall be carried out and the following additional tests made:

- Each luminaire and internally illuminated sign shall be tested monthly as above but for its full duration in accordance with the manufacturer's information.
- The normal supply for the luminaire should be restored and any charge indicator lamp or device should be checked to ensure that it shows the normal supply has been restored. The charging arrangements should be checked for proper functioning.
- The date of the test and its results shall be recorded in the system logbook.

A copy of this report must accompany any fitting returned to the manufacturer for any reason.

General Information

Our products are designed to comply with the requirements of UK law and the relevant industry national and international standards and should not be modified in any way. All emergency lighting systems should comply with the recommendations of BS5266-1: Code of Practice for the Emergency Lighting of Premises and be installed by competent engineers in accordance with the relevant wiring regulations. Before installing any type of Emergency Lighting always seek the advice and approval of the local Fire Prevention Officer (or equivalent authority).

Maintenance

Failed or faulty light sources connected to this equipment should be replaced immediately. These units are designed especially for a long and trouble free life. Under normal conditions, will require no routine maintenance or service beyond the inspection and test regime of BS5266-1.

Both mains supply and battery protection fusing is incorporated internally. Should access to these or any other part of the circuitry be required this must be undertaken only by suitably qualified person. Special care must be taken when removing the cover to circuitry and battery. Only replacement components authorised by the company must be used. Disposal of replaced components should be in accordance with the component manufacturers instructions.

Profile & Dimensions

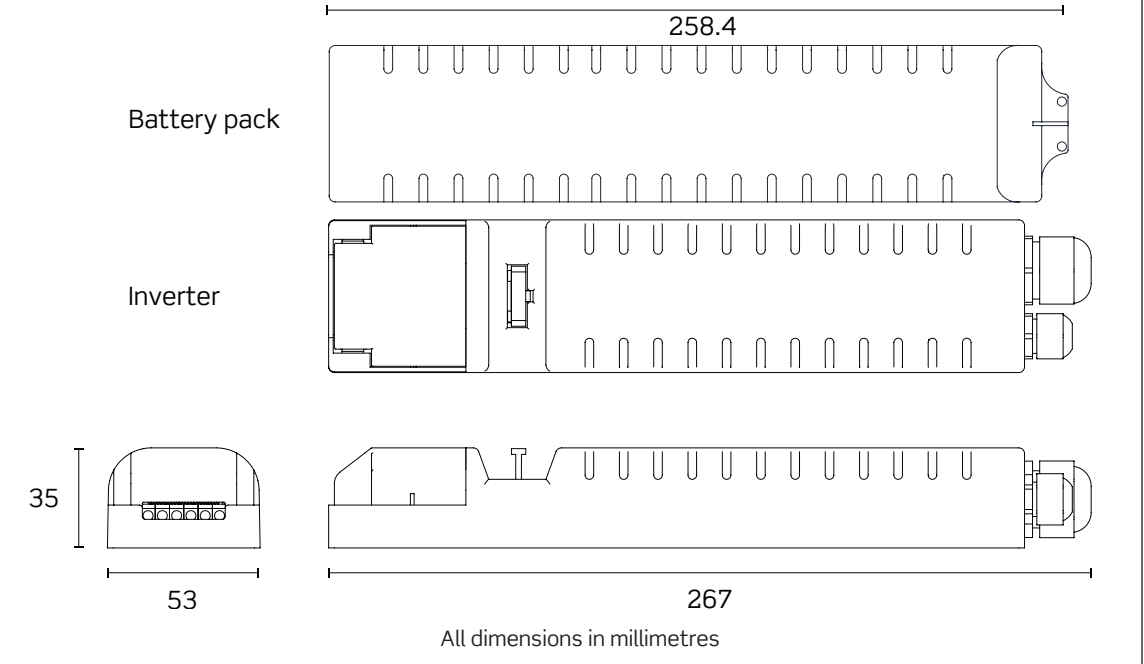

Emergency test record sheet

Month	Test Type	First Year		Second Year		Third Year		Fourth Year		Fifth Year	
		Sign	Date	Sign	Date	Sign	Date	Sign	Date	Sign	Date
January	Functional										
February	Functional										
March	Functional										
April	Functional										
May	Functional										
June	Functional										
July	Functional										
August	Functional										
September	Functional										
October	Functional										
November	Functional										
December	3 hour										