

TIMEGUARD®

8.5W/17W LED Slimline PIR Floodlights

Model: LED100PIRBP - Black (Single Flood)

Model: LED100PIRWHP - White (Single Flood)

Model: LED200PIRBP - Black (Twin Flood)

Model: LED200PIRWHP - White (Twin Flood)



Model: LED200PIRBP



Model: LED100PIRBP

Installation & Operating Instructions

1. General Information

These instructions should be read carefully and retained for further reference and maintenance.

Note: Timeguard reserve the right to alter these instructions at any time. Up to date instructions will always be available for download at www.timeguard.com

2. Safety

- Before installation or maintenance, ensure the mains supply to the luminaire is switched off and the circuit supply fuses are removed or the circuit breaker turned off.
- It is recommended that a qualified electrician is consulted or used for the installation of this luminaire and install in accordance with the current IEE wiring and Building Regulations.
- Check that the total load on the circuit including when this luminaire is fitted does not exceed the rating of the circuit cable, fuse or circuit breaker.
- To clean use a clean dry cloth only. Do not use liquid cleaners.

3. Technical Specifications

The specification below covers the single & twin head models.

- Mains Supply: 230V AC 50Hz
- This luminaire is of class II construction
- Energy Usage: 8.5KwH/1000H (Single Head)
17 KwH/1000H (Twin Head)
- Beam Angle (Per Spotlight): 98° x 98°
- Lamp Adjustment Pan and Tilt: Left and Right 40°
,Downward 70°
- Lumen Output: 1000lm (Single Head)
2000lm (Twin Head)
- Colour Temperature: 4000K
- Operating Temperature: -20°C to +50°C

- Back Box Mounting Hole Centres: 60mm
- IP Rating: IP55
- Motion Detection Range: Up to 10m at a 2.5m mounting height
- Detection Angle: 180°
- Time On Adjustment: 10 seconds to 30 minutes (10s, 30s, 1min, 2min to 30min)
- Lux Adjustment: 5 to 500 lux
- Standby Power Consumption: 0.4W
- PIR Warm Up Duration: 30 seconds (approx)
- Manual Pulse Override: Switch ON/OFF rocker switch within 2 seconds to enter 6 hours on time
- CE / UKCA Compliant
- Construction: Polycarbonate
- Dimensions Single Head (H x W x D): 160mm x 80mm x 50mm
Twin Head (H x W x D): 160mm x 167mm x 50mm

Other Loads - External Slave

- LED Lamps Max 100W
Slave terminal available for additional external lighting loads;
LED loads of 8W or above = 100W.
LED loads of 2W or less = 20W max LED. (10 Sets) .
LED loads over 2W and under 8W = 80W max LED. (10 Sets).

Other Loads - External Slave

- A maximum of 4 LED100/200PIR floodlights can be wired in parallel to enable any detector to turn ON all the lights connected.
Note: if you have the PIR floodlights set for different time durations, and you trigger more than one PIR sensor, the light will stay ON for duration of the highest set time.

4. Selecting a location

- The PIR sensor has a number of detection zones, at various vertical and horizontal angles as shown.

See image A

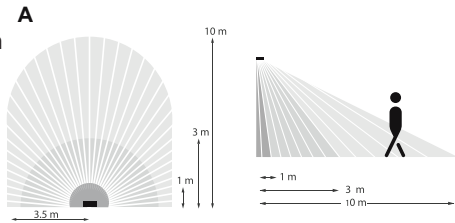

- The best all-round coverage is achieved with the floodlight mounted at the optimum height of 2.5 metres. See image B.

- Appropriate positioning of the PIR is required to ensure optimum performance.

- The PIR sensor is more sensitive to movement across its field of vision than to movement directly towards it. Therefore position the floodlight so that its PIR sensor looks across the likely approach path where possible.

- Avoid positioning the floodlight where there are any sources of heat in the detection area of its PIR sensor (extractor fans, tumble dryer or boiler exhausts etc.) including opposite any other light sources such as other security floodlights.

- Reflective surfaces (e.g. pools of water or white painted walls) and overhanging branches may cause false activation under extreme conditions.

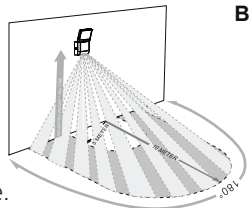

- During extreme weather conditions the PIR sensor may exhibit unusual behaviour. This does not indicate a fault with the product. Once normal weather conditions return, the PIR sensor will resume normal operation.

5. Installation

- Ensure the mains supply is switched off and the circuit supply fuses are removed or the circuit breaker turned OFF (See image 1).
- An isolating switch should be installed to enable the power to be switched ON and OFF for maintenance purposes.
- Disconnect the back box from the luminaire by releasing the lugs (left or right side). See Image 2.
- Firmly grip the back box with your hand, from top and bottom and carefully pull away from the luminaire. See Image 3.
- Mark the position of the mounting holes on the wall using the back box as a template (See image 4). Drill the holes ensuring not to infringe with any gas/water pipes or electrical cables that may be hidden below the surface. Insert the rawl plugs into the holes. Pass the 230V 50Hz supply and load cables through the cable entry points on the back box, ensuring the grommets are used to maintain the IP rating of the luminaire.

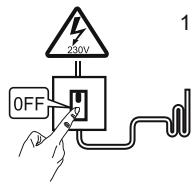

1

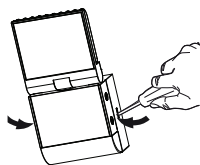

2

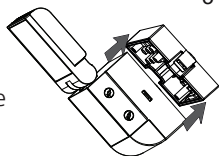

3

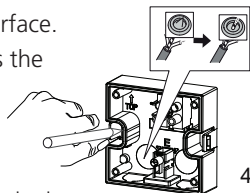

4

- Fix the back box to the wall using the 2 mounting screws, making sure it is the correct way up. Take care not to over-tighten the

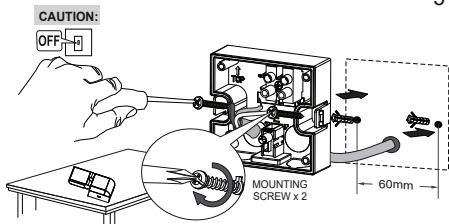

screws to prevent damage to the back box. If using a power screwdriver, use the lowest torque setting. See image 5.

- Terminate the 230V 50Hz mains supply cable into the terminal block (See image 6) ensuring that the correct polarity is observed and that all bare conductors are sleeved (See section 5. Connection Diagram). Note that rear and bottom cable entry points are available as shown on image 5 & 6..

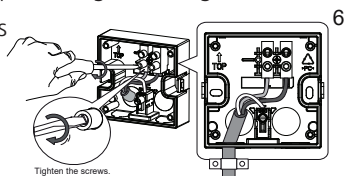

- Re-connect the luminaire to the back box ensuring the 2 lugs firmly latch on the left and right hand side, indicated by a 'click'. See image 7.

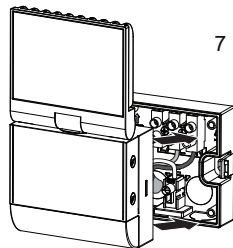

6. Connection Diagram

**230V AC 50Hz
MAINS SUPPLY**

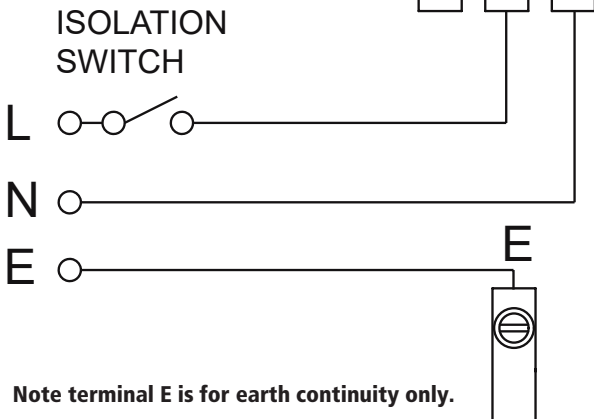

Note terminal E is for earth continuity only.

230V 50Hz Mains Supply

Live Supply (Brown or Red)	L
Neutral Supply (Blue or Black) to	N
Earth (Green/Yellow) to	E

For additional external (slave) lighting, connect the external load to the terminal block on the back box as follows:

Live Supply (Brown or Red)	L↓
Neutral Supply (Blue or Black) to	N
Earth (Green/Yellow) to	E

Parallel Switching

- A maximum of 4x LED100/200PIR twin floodlights can be wired in parallel to enable any detector to turn ON all the lights connected.
- Please refer to the following diagram which shows an example of 2x LED100/200PIR floodlights connected in parallel, with two slave (non PIR controlled) floodlights at the same time:

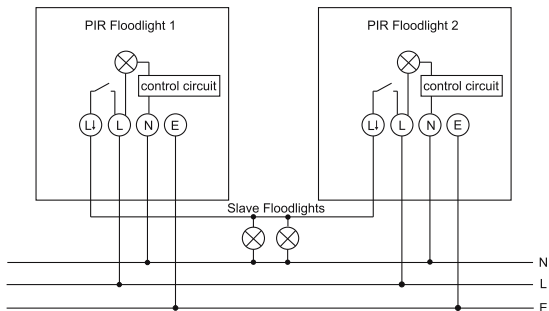

7. Setting Up

Walk Test Procedure (Test Mode)

- Make sure the PIR sensor is set to Test Mode i.e. the time on adjustment to the minimum (fully anti-clockwise) position, and the Lux Level set the Sun symbol (fully clockwise). A thin flat head screwdriver or a 2.5mm Allen key can be used for adjustments.
- Turn the power to the unit ON. The lamp will immediately illuminate as the unit goes through its warm-up period. After approximately 30 seconds the lamp will extinguish. This indicates the unit is wired correctly and the unit is in Test Mode. Remain outside the detection area during the warm-up period.

- The unit will now operate during daytime as well as at night, this allows testing to be carried out to establish whether the sensor is covering the required area. Walk across the location the sensor is fitted, to establish the detection zone.
- The sensor will detect you approximately up to 10 metres forward at mounting height of 2.5m. As you cross the detection zone, the lamp will illuminate. When no movement is detected the lamp will extinguish.
- Repeat the above, at various distances and angles to confirm the detection area is suitable.
- When the walk tests are complete, the unit can be adjusted for automatic operation.
- The time on adjustment controls how long the unit remains illuminated following activation and after all motion ceases.
- Use a thin flat blade screwdriver to make adjustments.
- The LUX Level adjustment determines the level of darkness required for the unit to start operating. The setting is best achieved by the procedure below;
 1. Set the LUX Level adjustment knob fully clockwise (Sun symbol).
 2. When the ambient light level reaches the level of darkness at which you wish the lamp to become operative (i.e. at dusk) slowly rotate the control in an anti-clockwise direction until a point is reached where the lamp illuminates.
 3. Leave the dial set at this point.
- At this position the unit should operate at approximately the same level of darkness each evening.
- Continue to adjust until the unit operates as desired.

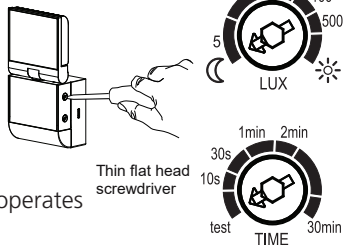

8. Lamp Adjustment

- Pan/Tilt adjustment options (Single Head).

Frontwards
Down 70°

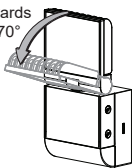

Backwards
Down 60°

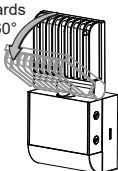

Left & Right 40° (limited by wall)

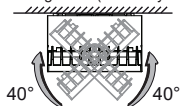

- Pan/Tilt adjustment options (Twin Head).

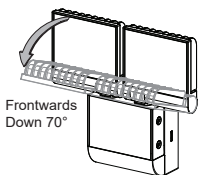

Frontwards
Down 70°

Pan Outward 21° (limited by wall)
Pan Inward 45°

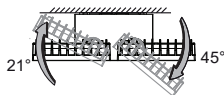

Pan Outward 45°, Pan Inward 45°
- with corner bracket

9. Manual Override

- The light can be switched ON extended periods by use of the manual override function. This can be activated after dusk by using the internal wall switch or circuit breaker.
- Switch the internal wall switch twice (OFF/ON, OFF/ON) within 2 seconds. The floodlight will now illuminate continuously for 6 hours, unless it is either switched back into auto mode, or dawn arrives prior to the 6 hour on time, which will result in the luminaire switching off.
- To reset the 6 hour ON time, switch the internal wall switch twice, (OFF/ON, OFF/ON) within 2 seconds.
- To return to auto mode, switch the internal wall switch once (OFF/ON) within 2 seconds. The floodlight will return to auto mode, and will operate normally as set up.

10. Lens Mask Sticker

- There is 1x lens mask sticker included in the accessory pack.
- The purpose of the lens mask sticker is to mask out areas not desired for detection. You can restrict left or right detection, or reduce detection zone to cover a smaller area.

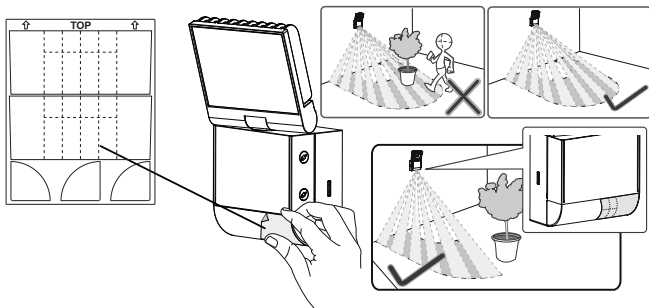

10

3 Year Guarantee

In the unlikely event of this product becoming faulty due to defective material or manufacture, within 3 years of the date of purchase, please return it to your supplier with proof of purchase and it will be replaced free of charge. For years 2 to 3 or with any difficulty in the first year, telephone our helpline.

Note: a proof of purchase is required in all cases.

For all eligible replacements (where agreed by Timeguard), the customer is responsible for all shipping/postage charges outside of the UK. All shipping costs are to be paid in advance before a replacement is sent.



If you experience problems, do not immediately return the unit to the store.

Email the Timeguard Customer Helpline:

HELPLINE

helpline@timeguard.com

or call the helpdesk on 020 8450 0515

Qualified Customer Support Coordinators will be online to assist in resolving your query.



A **theben** Group Company

For a product brochure please contact:

Timeguard Limited.

Victory Park 400 Edgware Road,
London NW2 6ND

Sales Office: 02084521112
or email csc@timeguard.com

www.timeguard.com

67.058.695 (Issue 1)