



GS3

Term Tech Grommet Strip Plain Profile Natural 1.6mm-2mm Panel Thickness (25m Coil)



The Termination Technology range of Grommet Strips are perfect for protecting cables and conduits from sharp edges created from cutting through sheet metal and panels. Available in a Plain profile and Castellated profile to cover a range of panel thicknesses in a natural colour. A Black option is also available in the most common size.

Technical Data

Colour and Material

Material	Polyethylene (PE)
Colour	Natural

Dimensions

Dimension A (mm)	2
Dimension B (mm)	3
Dimension C (mm)	4.3
Dimension D (mm)	4.3
Product Length (m)	25

Electrical Ratings

Dielectric Strength (kV/mm)	60
-----------------------------	----

Physical Attributes

Tensile Strength (Mpa)	>12 at Break
Maximum Elongation (%)	>550

Temperature and Fire Information

Continuous Operating Temperature (°C)	-50 to +85
---------------------------------------	------------

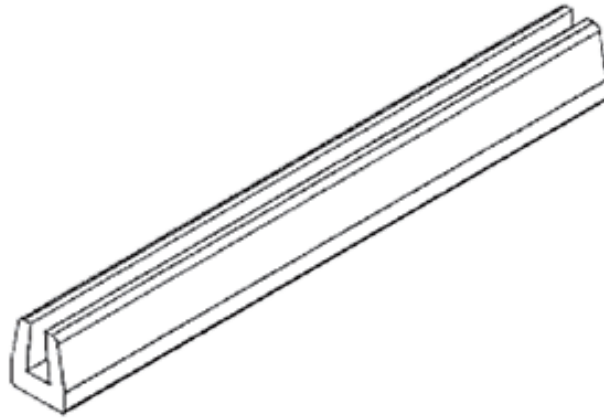
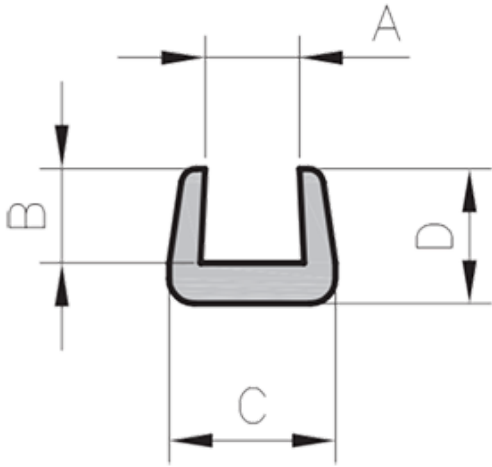
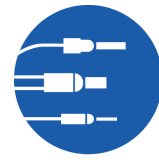

**Termination
Technology Ltd**

Quality and Service

The company with the RIGHT connections at the RIGHT price.

Company Registration Number: 05062297

W: www.termtech.co.uk

T: 01179 354 900

E: sales@termtech.co.uk

Termination Technology Ltd, Unit 4C Crofts End Ind Estate, Crofts End Road,
Bristol BS5 7UW

