

Exova Warringtonfire
Holmesfield Road
Warrington
WA1 2DS
United Kingdom

T : +44 (0) 1925 655 116
F : +44 (0) 1925 655 419
E : warrington@exova.com
W: www.exova.com



Title:

The Fire Resistance Performance of a Loadbearing Timber Floor Assembly Protected by a Plasterboard Ceiling Designed to Provide 30 minutes Fire Resistance, Incorporating Twenty Three Downlight Fittings, When Tested Accordance with BS EN 1365 - 2: 2014

WF Report No: 385023-B

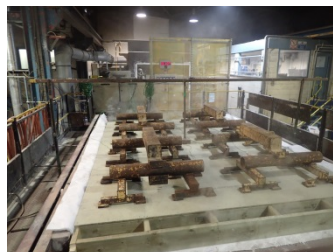

Prepared for:

Integral LED

Unit 6, Iron Bridge Close, Iron Bridge Business Park, London, NW10 0UF, UK

Date:

26th January 2018

Notified Body No:

0833



0249

This test report is additional to that issued as WF Test report No. 385023 and dated 15th December 2017. The original test report remains valid and is not replaced by this additional test report.

Summary

Objective To determine the fire resistance performance of a loadbearing timber floor assembly protected by a plasterboard ceiling designed to provide 30 minutes fire resistance, incorporating twenty three down light fittings, when tested in accordance with BS EN 1365 - 2: 2014.

Sponsor **Integral LED**
Unit 6, Iron Bridge Close, Iron Bridge Business Park, London, NW10 0UF, UK

Summary of Tested Assembly Briefly, the timber floor had overall nominal dimensions of 4500 mm long by 3000 mm wide and comprised softwood timber joists at 600 mm centres. The upper surface of the floor comprised nominally 22 mm thick tongue and grooved chipboard flooring.

The floor assembly was protected on its underside by a direct fixed ceiling, formed from a single layer of 12.5 mm thick British Gypsum Fireline plasterboard, the ceiling was screw fixed to the underside of the floor joists.

The floor supported an evenly distributed load of 0.876 kN/m².

The ceiling incorporated 22 down lighter light fittings, 2 of which are subject to this test report and were referenced as follows:

Test Ref.	Model Ref.	Description
I	ILD LFR70A XXX	Round, fixed, LED recessed downlight
M	ILD LFR92C XXX	Round, tiltable, LED recessed downlight
A-H, J-L and N-W	Items reported separately	

Test Results:

Loadbearing Capacity	35 minutes*
<hr/>	
Integrity Performance	
Sustained flaming	35 minutes*
Gap gauge	35 minutes*
Cotton pad	35 minutes*
<hr/>	
Insulation	35 minutes*

*The test was discontinued after a period of 35 minutes.

Date of Test 24th August 2017

This report may only be reproduced in full. Extracts or abridgements of reports shall not be published without permission of Exova Warringtonfire.

Signatories



Responsible Officer
D. Fitzsimmons*
Technical Officer



Approved
W. Drazkiewicz*
Technical Officer



Head of Department
S. Hankey*
Business Unit Head

* For and on behalf of **Exova Warringtonfire**.

Report Issued

Date : 26th January 2018

This test report is additional to that issued as WF Test report No. 385023 and dated 15th December 2017. The original test report remains valid and is not replaced by this additional test report.

This copy has been produced from a .pdf format electronic file that has been provided by **Exova Warringtonfire** to the sponsor of the report and must only be reproduced in full. Extracts or abridgements of reports must not be published without permission of **Exova Warringtonfire**. The pdf copy supplied is the sole authentic version of this document. All pdf versions of this report bear authentic signatures of the responsible **Exova Warringtonfire** staff.

CONTENTS	PAGE NO.
SUMMARY	2
SIGNATORIES.....	4
TEST PROCEDURE	6
TEST SPECIMEN	7
SCHEDULE OF COMPONENTS	11
INSTRUMENTATION.....	13
TEST OBSERVATIONS	14
TEST PHOTOGRAPHS.....	15
TEMPERATURE & DEFLECTION DATA	17
LOAD CALCULATIONS.....	26
PERFORMANCE CRITERIA AND TEST RESULTS.....	28
ONGOING IMPLICATIONS	28
CONCLUSIONS.....	29
DIRECT FIELD OF APPLICATION	30

Test Procedure

Introduction	<p>The specimen tested was of a loadbearing timber floor construction protected by a direct fix ceiling assembly. The test was conducted in accordance with BS EN 1365-2: 2014, 'Fire resistance tests for loadbearing elements – Part 2: Floors and Roofs'. This test report should be read in conjunction with that Standard and with BS EN 1363-1: 2012, 'Fire resistance tests part 1, general requirements' and BS EN 1363-2: 1999, 'Fire resistance tests part 2, alternative and additional procedures'.</p> <p>The purpose of the test was to evaluate the performance of a timber floor construction protected by a ceiling of known fire resistance, when incorporating down lighter light fitting assemblies.</p> <p>The specimen was judged on its ability to comply with the performance criteria for loadbearing capacity, integrity and insulation, as required by BS EN 1365-2: 2014.</p>
Fire Test Study Group/EGOLF	<p>Certain aspects of some fire test specifications are open to different interpretations. The Fire Test Study Group and EGOLF have identified a number of such areas and have agreed Resolutions which define common agreement of interpretations between fire test laboratories which are members of the Groups. Where such Resolutions are applicable to this test they have been followed.</p>
Instruction To Test	<p>The test was conducted on the 24th August 2017 at the request of Integral LED, the test sponsor.</p>
Test Assembly Construction	<p>A comprehensive description of the test construction is given in the Schedule of Components. The description is based on a detailed survey of the specimen and information supplied by the sponsor of the test.</p>
Installation	<p>Representatives of Exova Warringtonfire assembled the floor construction and installed the downlighters between the 21st and 24th August 2017.</p>
Conditioning	<p>The specimens' storage, construction, and test preparation took place in the test laboratory over a total combined time of 4 days. Throughout this period of time both the temperature and the humidity of the laboratory were measured and recorded as being within a range of from 18°C to 26.5°C and 55.5% to 80% respectively.</p>

Test Specimen

Figure 1- General Elevation of Test Specimen

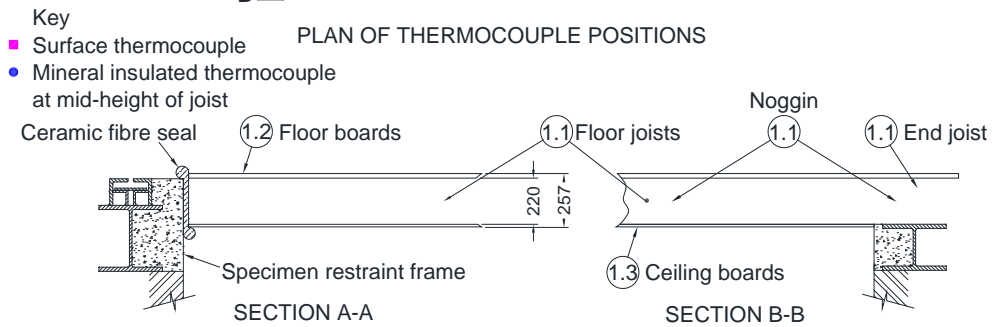
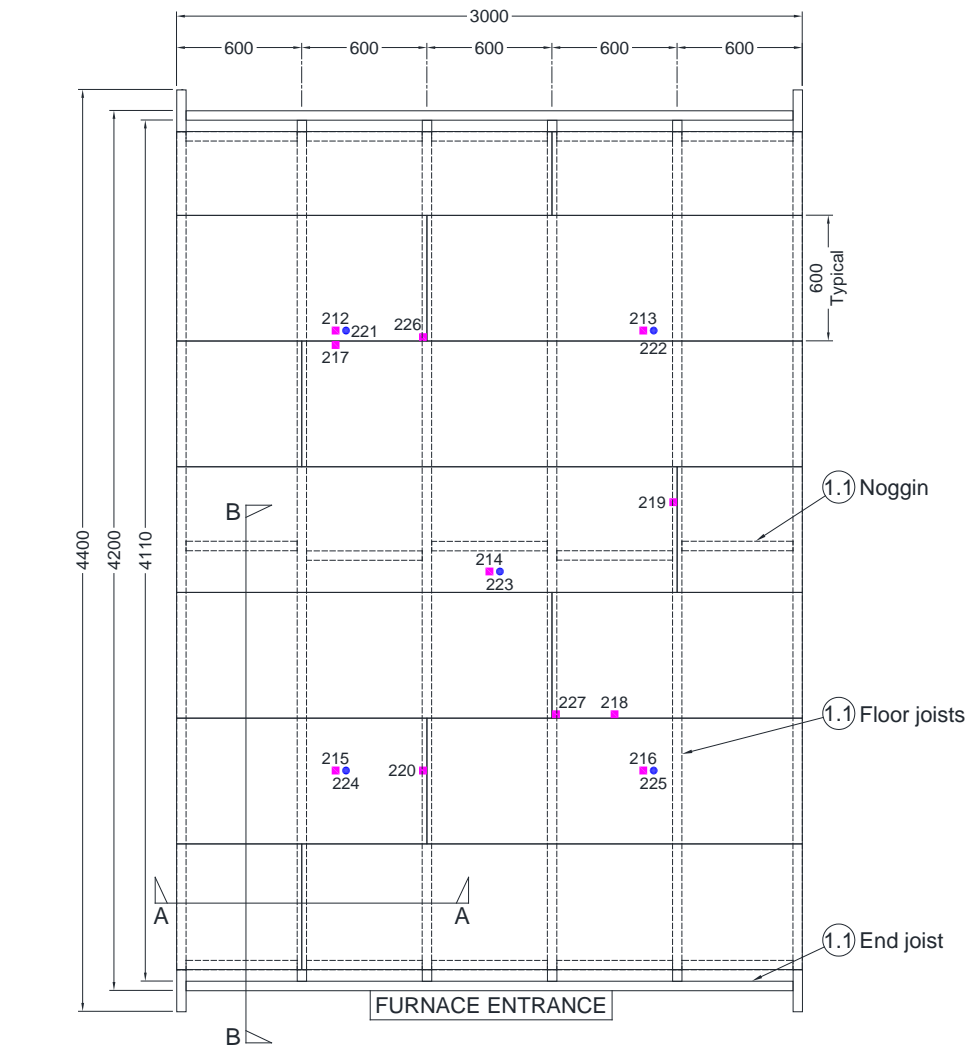

Do not scale. All dimensions are in mm

Figure 2 – Details of Downlighter Positions

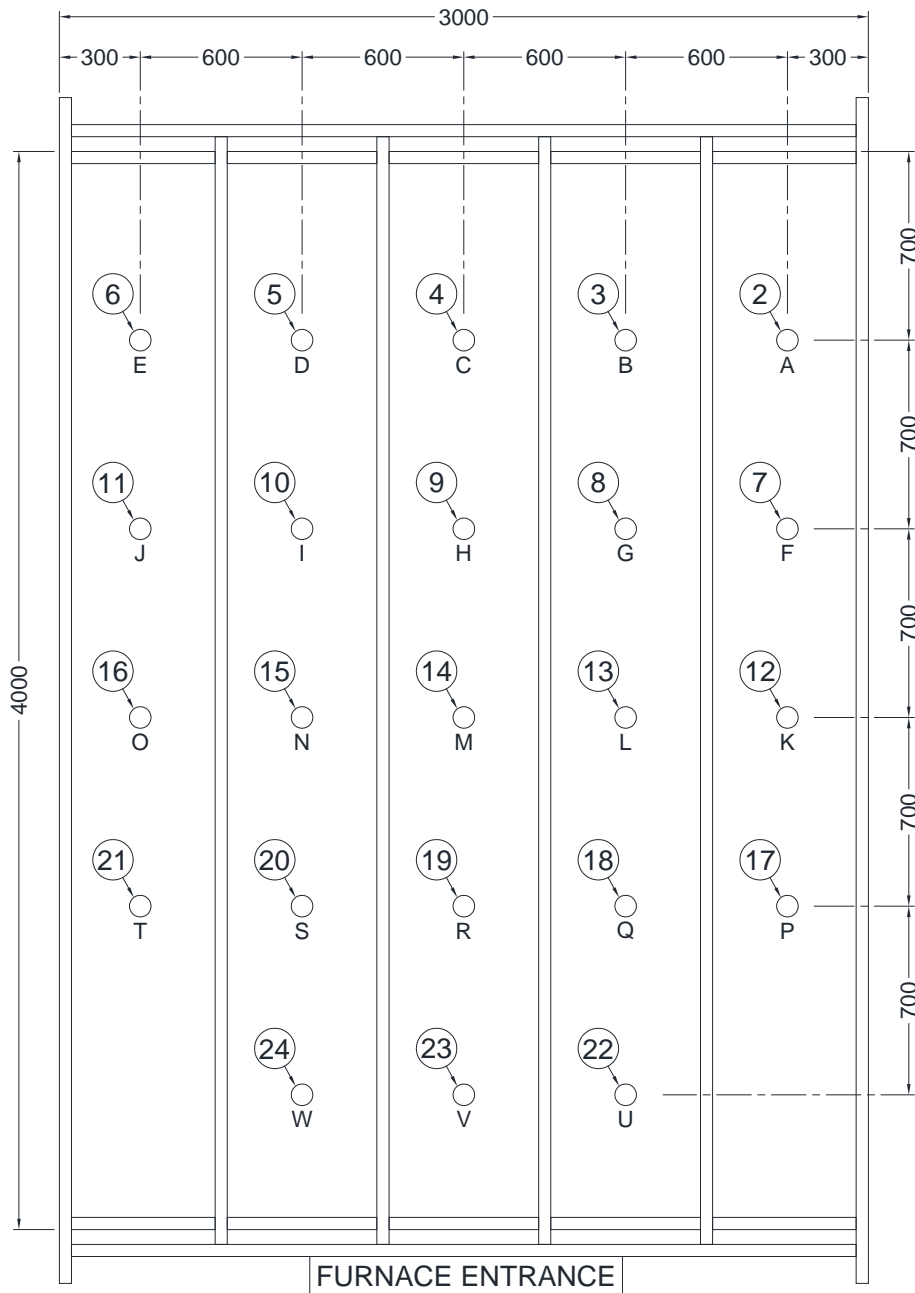

Do not scale. All dimensions are in mm

Figure 3 – Details of Downlighters Specimen I

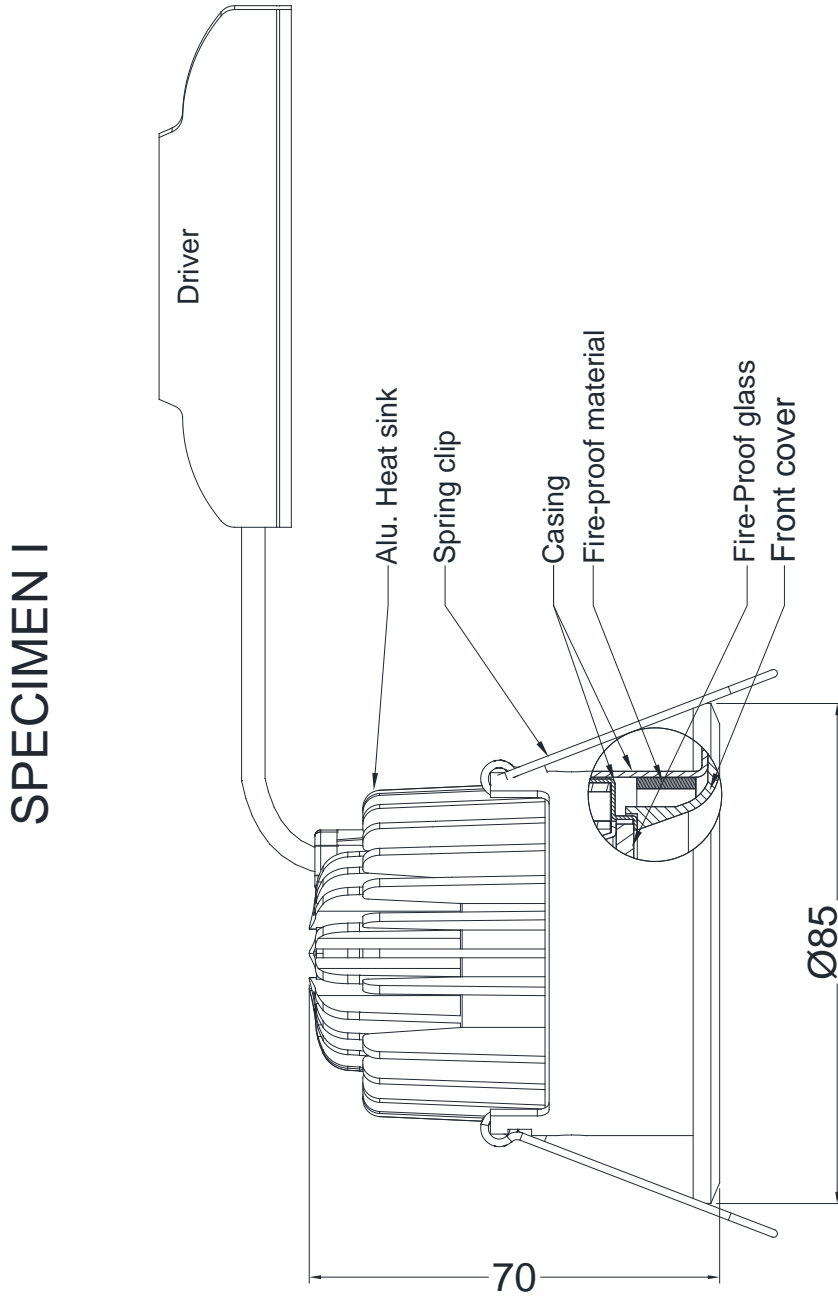

SPECIMEN I

Fixed
With reflector ILDLFR70AXXX
Cut out: Ø70

Do not scale. All dimensions are in mm

Figure 4 – Details of Downlighters Specimen M

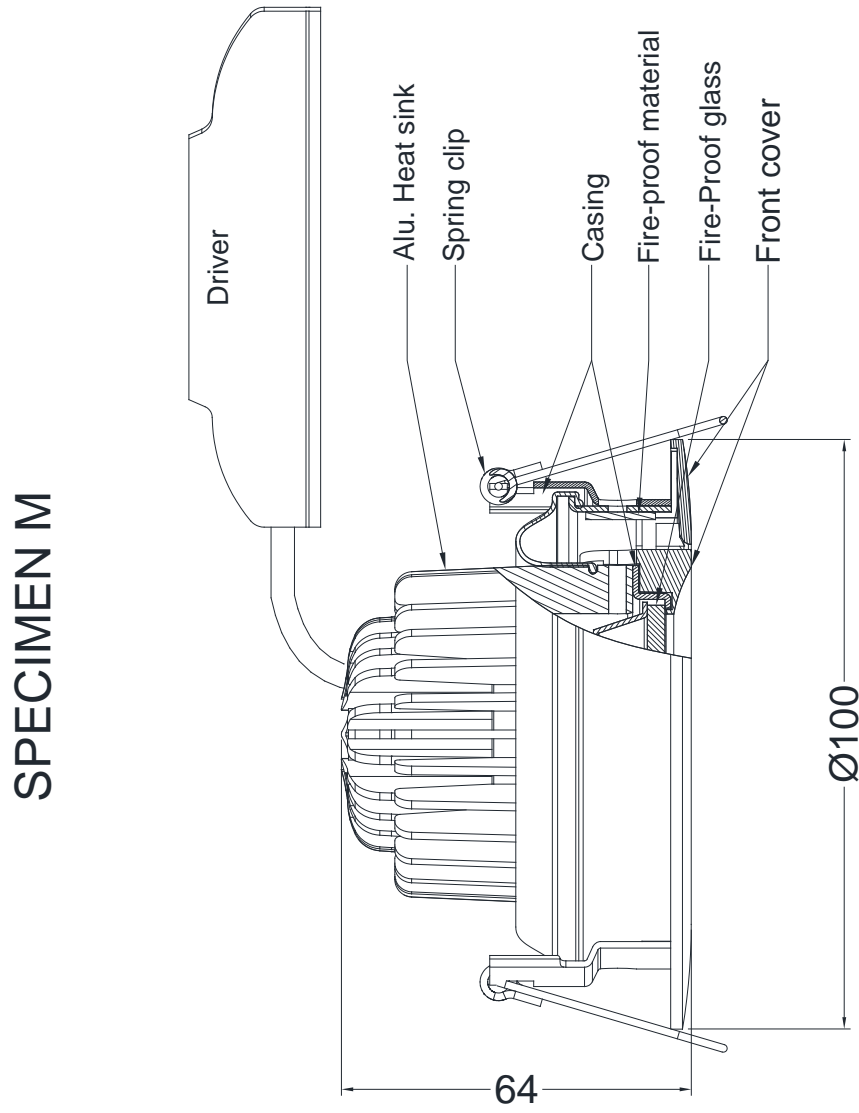

SPECIMEN M

Tilttable
With reflector ILDLFR92CXXX
Cut out: Ø92

Do not scale. All dimensions are in mm

Schedule of Components

(Refer to Figures 1 to 4)
(All values are nominal unless stated otherwise)
(All other details are as stated by the sponsor)

<u>Item</u>	<u>Description</u>
1. Timber Floor	
1.1 Floor Joists	
Material	: British Home-grown, rough sawn softwood, kiln dried
Grade	: C16, to BS EN 519
Density	: 511 kg/m ³
Size	: 45 mm x 197 mm
Joist centres	: 600 mm
1.2 Noggins	
Material	: British Home-grown, rough sawn softwood, kiln dried
Grade	: C24, to BS EN 519
Density	: 511 kg/m ³
Size	: 65 mm x 45 mm
Joist centres	: 1200 mm
1.3 Floor Boards	
Material	: Flooring grade tongue and groove chipboards
Reference	: FSC E1 P5
Thickness	: 22 mm
Size	: 600 mm wide
Fixing	: Fixed in a single layer with 6 mm diameter x 60 mm long countersunk steel screws to floor joists at 300 mm centres
1.4 Ceiling Boards	
Manufacturer	: British Gypsum
Type / reference	: Gyproc Fireline Wallboard
Density	: 803 kg/m ³
Thickness	: 12.5 mm thick
Fixing	
i. method	: The boards were screw fixed to the soffit of the joists with all joints in the second layer staggered with respect to those of the first layer
ii. fixings	: Drywall self drill and tapping screws 38 mm and 50 mm long for the 1 st and 2 nd board layers respectively
iii. frequency	: 150 mm centres along joints and 150 mm to the perimeter of the ceiling

<u>Item</u>	<u>Description</u>
2. Specimen A	: Item reported separately
3. Specimen B	: Item reported separately
4. Specimen C	: Item reported separately
5. Specimen D	: Item reported separately
6. Specimen E	: Item reported separately
7. Specimen F	: Item reported separately
8. Specimen G	: Item reported separately
9. Specimen H	: Item reported separately
10. Specimen I	
Manufacturer	: Integral LED
Type	: Round, fixed, LED recessed downlight
Reference	: ILDLFR70AXXX
Materials	
i. casing	: Mild steel
ii. front cover	: Die cast aluminium
iii. heat sink	: Die cast aluminium
iv. spring clip	: Stainless steel
v. gasket	: 4.3 mm wide x 1.7 mm thick flexible plastics ring
Overall dimensions and construction	: See Figure 11 for details
Cut out size	: 70 mm diameter
Driver	: None
Lamp	: COB
11. Specimen J	: Item reported separately
12. Specimen K	: Item reported separately
13. Specimen L	: Item reported separately
14. Specimen M	
Manufacturer	: Integral LED
Type	: Round, tiltable, LED recessed downlight
Reference	: ILDLFR92CXXX
Materials	
i. casing	: Mild steel
ii. front cover	: Die cast aluminium
iii. heat sink	: Die cast aluminium
iv. spring clip	: Stainless steel
v. gasket	: 4.3 mm wide x 1.7 mm thick flexible plastics ring
Overall dimensions and construction	: See Figure 15 for details
Cut out size	: 92 mm diameter
Driver	: None
Lamp	: COB
15. Specimen N	: Item reported separately
16. Specimen O	: Item reported separately
17. Specimen P	: Item reported separately
18. Specimen Q	: Item reported separately
19. Specimen R	: Item reported separately
20. Specimen S	: Item reported separately
21. Specimen T	: Item reported separately
22. Specimen U	: Item reported separately
23. Specimen V	: Item reported separately
24. Specimen W	: Item reported separately

Instrumentation

General	The instrumentation was provided in accordance with the requirements of the Standard.
Furnace	The furnace was controlled so that its mean temperature complied with the requirements of BS EN 1363-1: 2012, using eight plate thermometers distributed over a plane 100 mm from the underside of the test construction.
Thermocouple Allocation	Thermocouples were provided to monitor the unexposed surface of the floor assembly and the output of all instrumentation was recorded at no less than one minute intervals as follows:
Thermocouples 212 to 216	At five positions on the unexposed surface of the floor assembly, one approximately at the centre and one at approximately the centre of each quarter section.
Thermocouples 217 to 220 & 226 to 227	At six positions on the unexposed surface of the floor assembly, positioned adjacent to joints in the floor boarding.
Thermocouples 221 to 225	<p>At five positions in the air cavity of the floor assembly, one approximately at the centre and one at approximately the centre of each quarter section.</p> <p>The locations and reference numbers of the various unexposed surface and internal thermocouples are shown in Figure 1.</p>
Roving Thermocouple	A roving thermocouple was available to measure temperatures on the unexposed surface of the specimen at any position which might appear to be hotter than the temperatures indicated by the fixed thermocouples.
Furnace Pressure	After the first five minutes of testing and for the remainder of the test. The calculated pressure differential relative to the laboratory atmosphere 100 mm away from the underside of the assembly was 20(+0, -5) Pa between 5 and 10 minutes of testing and 20(+0, -3) Pa after 10 minutes of testing and for the remainder of the test.
Loadbearing Capacity Criteria	Linear deflection transducer was provided at the approximate centre on the unexposed surface of the specimen to record its vertical deflection.
Integrity Criteria	Cotton pads and gap gauges were available to evaluate the integrity of the floor assembly.

Test Observations

Time		All observations are from the unexposed face unless noted otherwise.
mins	secs	The ambient air temperature in the vicinity of the test construction was 21°C at the start of the test with a maximum variation of +1°C during the test.
00	00	The test commences.
04	00	Very light steam/smoke release is observed from latitude edges of the specimen.
07	00	When viewed from the exposed face, the paper face of the boards is observed charring away as small hairline cracks begin to form.
12	00	Steam/smoke release from the latitude edges increases.
14	00	When viewed from the exposed face, the joints between the boards are expanding.
17	00	Steam/smoke release from the latitude edges continues to slightly increase.
20	00	When viewed from the exposed face, the joints between the boards continue to slowly expand.
26	00	Steam/smoke release form the latitude edges continues to slightly increase.
31	00	When viewed from the exposed face, the joint between the boards continue to slightly expand.
35	00	The test is discontinued.

Test Photographs

The exposed face of the assembly prior to the start of the test



The unexposed face of the assembly after 10 minutes of testing



The unexposed face of the assembly after 20 minutes of testing



The unexposed surface of the assembly after a test duration of 30 minutes



Temperature & Deflection Data

Mean furnace temperature, together with the temperature/time relationship specified in the Standard

Time Mins	Specified Furnace Temperature Deg. C	Actual Furnace Temperature Deg. C
0	20	44
1	349	285
2	445	461
3	502	538
4	544	580
5	576	596
6	603	612
7	626	623
8	646	638
9	663	662
10	678	671
11	693	687
12	706	698
13	717	705
14	728	731
15	739	748
16	748	754
17	757	762
18	766	769
19	774	776
20	781	783
21	789	790
22	796	798
23	802	803
24	809	809
25	815	815
26	820	820
27	826	824
28	832	831
29	837	836
30	842	840
31	847	844
32	852	850
33	856	857
34	860	864
35	865	871

Individual and mean temperatures recorded on the unexposed surface of the floor assembly

Time Mins	T/C Number 212 Deg. C	T/C Number 213 Deg. C	T/C Number 214 Deg. C	T/C Number 215 Deg. C	T/C Number 216 Deg. C	Mean Temp Deg. C
0	24	24	24	21	22	23
1	24	24	24	21	22	23
2	24	24	24	21	22	23
3	24	24	24	21	22	23
4	24	24	24	21	22	23
5	24	24	24	21	22	23
6	24	24	24	22	22	23
7	24	24	24	22	22	23
8	24	25	24	22	22	23
9	25	25	24	23	23	24
10	25	26	24	23	23	24
11	26	26	25	24	24	25
12	27	27	25	25	25	26
13	27	28	25	26	25	26
14	28	29	26	27	26	27
15	29	30	26	28	27	28
16	30	31	27	29	28	29
17	31	31	27	30	29	30
18	32	32	28	31	31	31
19	33	33	29	32	32	32
20	34	34	29	33	33	33
21	35	35	30	34	34	34
22	36	36	30	35	35	34
23	37	37	31	36	36	35
24	39	38	32	38	37	37
25	41	39	33	40	39	38
26	44	41	33	43	41	40
27	47	43	34	47	44	43
28	51	46	35	51	47	46
29	55	49	36	56	51	49
30	59	53	38	60	55	53
31	64	57	39	66	59	57
32	68	61	41	71	63	61
33	71	65	43	76	67	64
34	73	68	46	81	71	68
35	75	71	48	84	74	70

Individual temperatures recorded adjacent to joints in the flooring

Time Mins	T/C Number 217 Deg. C	T/C Number 218 Deg. C	T/C Number 219 Deg. C	T/C Number 220 Deg. C	T/C Number 226 Deg. C	T/C Number 227 Deg. C
0	22	22	22	22	20	20
1	22	22	22	22	20	20
2	22	22	22	22	20	20
3	22	22	22	22	20	21
4	22	22	22	22	20	21
5	22	22	22	22	20	21
6	22	22	22	22	20	21
7	22	22	22	22	21	21
8	23	23	22	23	21	22
9	23	23	22	23	21	22
10	23	24	23	23	21	23
11	24	24	23	24	22	23
12	25	25	23	24	22	24
13	26	26	23	25	23	25
14	27	27	24	26	24	26
15	28	28	24	27	25	27
16	29	29	24	28	26	28
17	30	30	25	29	27	30
18	31	32	25	30	28	31
19	33	33	26	31	29	32
20	34	34	26	31	30	34
21	35	35	27	32	31	36
22	36	37	27	33	32	38
23	37	38	28	34	33	40
24	39	40	28	35	34	43
25	41	42	29	36	35	45
26	44	44	30	37	36	47
27	46	47	30	38	37	50
28	50	51	32	39	39	52
29	54	54	33	40	41	54
30	58	58	34	42	42	57
31	62	62	36	44	44	59
32	66	65	38	46	46	61
33	71	69	40	50	48	63
34	74	72	42	53	50	66
35	78	74	44	58	53	68

Individual temperatures recorded in the air cavity

Time Mins	T/C Number 221 Deg. C	T/C Number 222 Deg. C	T/C Number 223 Deg. C	T/C Number 224 Deg. C	T/C Number 225 Deg. C
0	25	25	23	24	24
1	26	25	23	25	24
2	35	35	24	43	37
3	57	58	28	60	60
4	67	68	32	68	69
5	74	75	37	73	73
6	77	81	42	81	80
7	80	86	46	88	90
8	84	93	50	95	96
9	91	99	54	99	100
10	101	101	58	101	103
11	106	103	62	103	107
12	109	104	66	105	110
13	111	106	69	108	112
14	115	109	71	111	115
15	124	114	74	116	122
16	144	126	76	127	130
17	169	149	77	155	150
18	188	168	79	188	178
19	206	186	81	221	208
20	221	202	83	235	227
21	238	216	85	251	242
22	250	228	88	268	256
23	261	244	90	276	270
24	274	251	94	289	281
25	284	277	96	303	292
26	305	299	97	312	303
27	322	309	97	324	310
28	334	316	97	334	318
29	344	324	98	341	326
30	356	334	100	349	334
31	366	343	107	357	341
32	375	351	113	369	350
33	384	358	120	384	360
34	393	366	126	392	366
35	407	375	133	404	376

Deflection of the floor assembly during the test

Time Mins	Central Vertical Deflection mm	Rate Of Deflection mm/min
0	0.0	0.0
1	2.6	2.6
2	3.1	0.6
3	3.2	0.1
4	3.1	-0.1
5	3.1	0.0
6	3.2	0.1
7	3.4	0.2
8	3.4	0.0
9	3.5	0.1
10	3.5	0.0
11	3.7	0.2
12	3.8	0.2
13	4.0	0.2
14	4.3	0.3
15	4.3	0.1
16	4.4	0.1
17	4.6	0.2
18	4.8	0.2
19	5.1	0.3
20	5.2	0.1
21	5.5	0.3
22	6.0	0.5
23	6.6	0.5
24	7.1	0.6
25	7.9	0.8
26	8.8	0.9
27	9.9	1.1
28	11.1	1.3
29	12.6	1.5
30	14.2	1.6
31	16.0	1.8
32	18.0	2.0
33	20.1	2.1
34	21.8	1.8
35	24.4	2.6

Recorded Furnace 100 mm below the floor assembly

Time Mins	Recorded Pressure Pascals
0	-24
1	-17
2	21
3	17
4	17
5	18
6	18
7	19
8	18
9	20
10	20
11	17
12	17
13	18
14	14
15	18
16	19
17	20
18	22
19	21
20	19
21	20
22	18
23	19
24	19
25	18
26	21
27	18
28	18
29	19
30	21
31	22
32	22
33	23
34	23
35	15

Graph showing specified and actual furnace temperatures

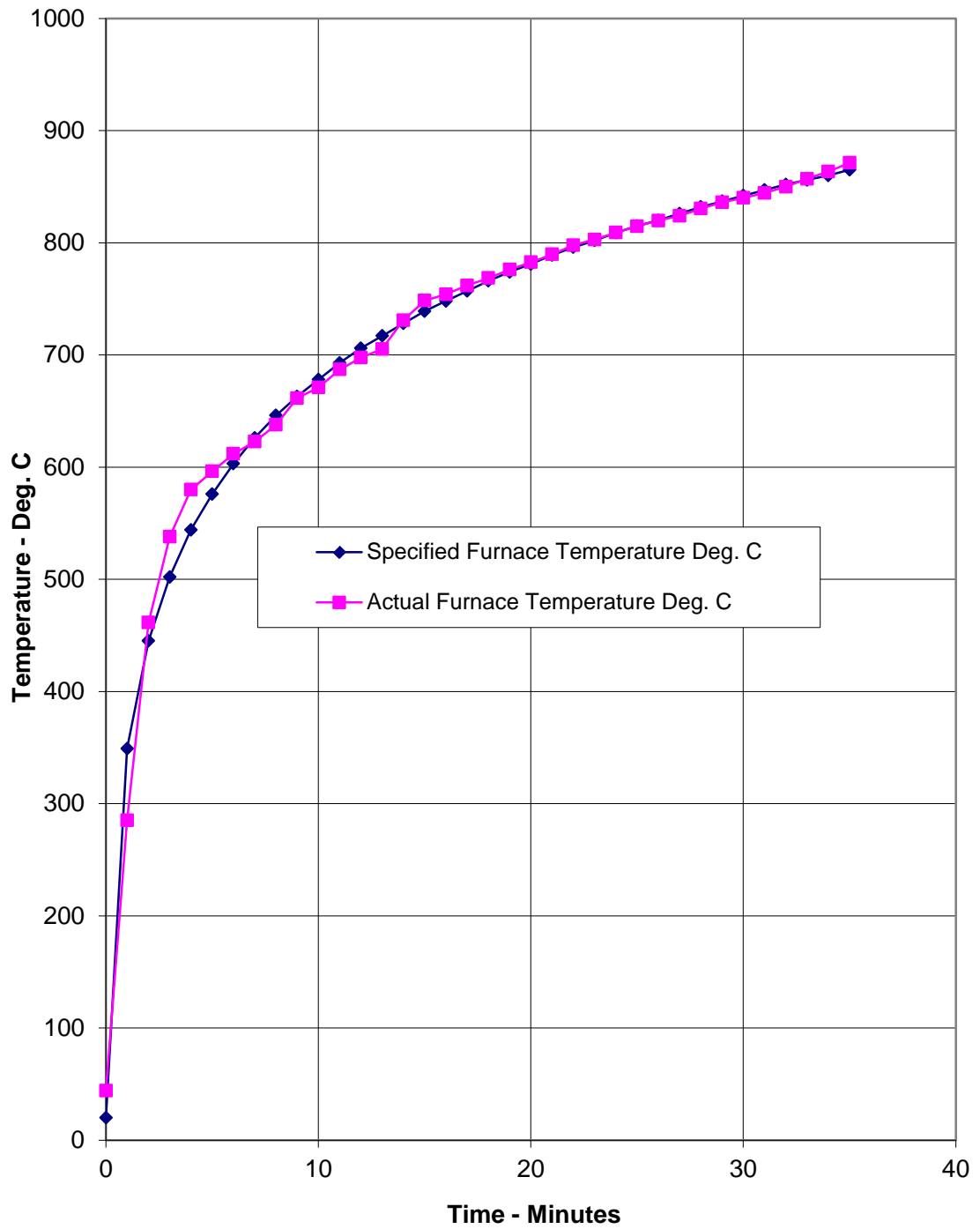

Graph showing mean unexposed surface temperature of the floor assembly

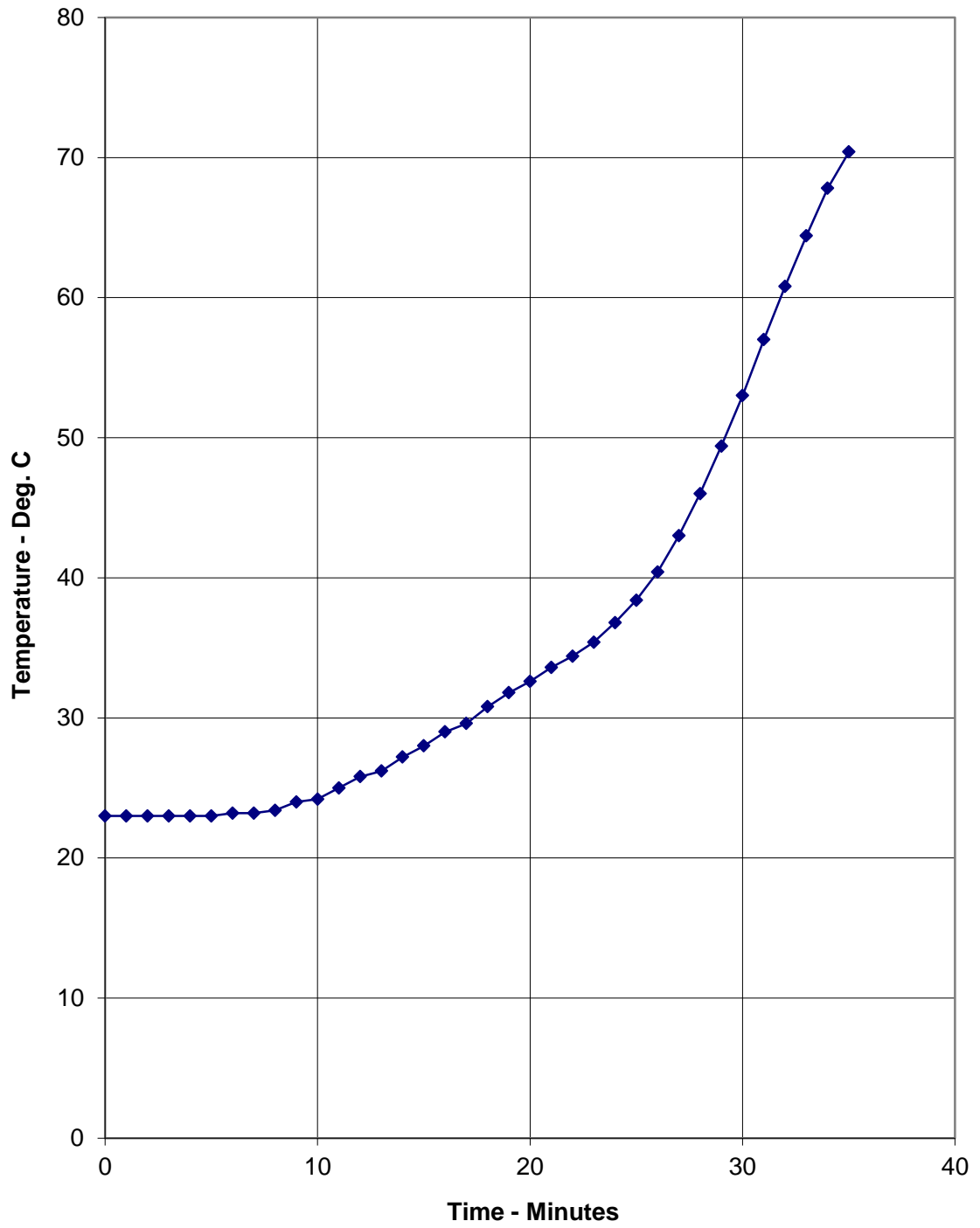

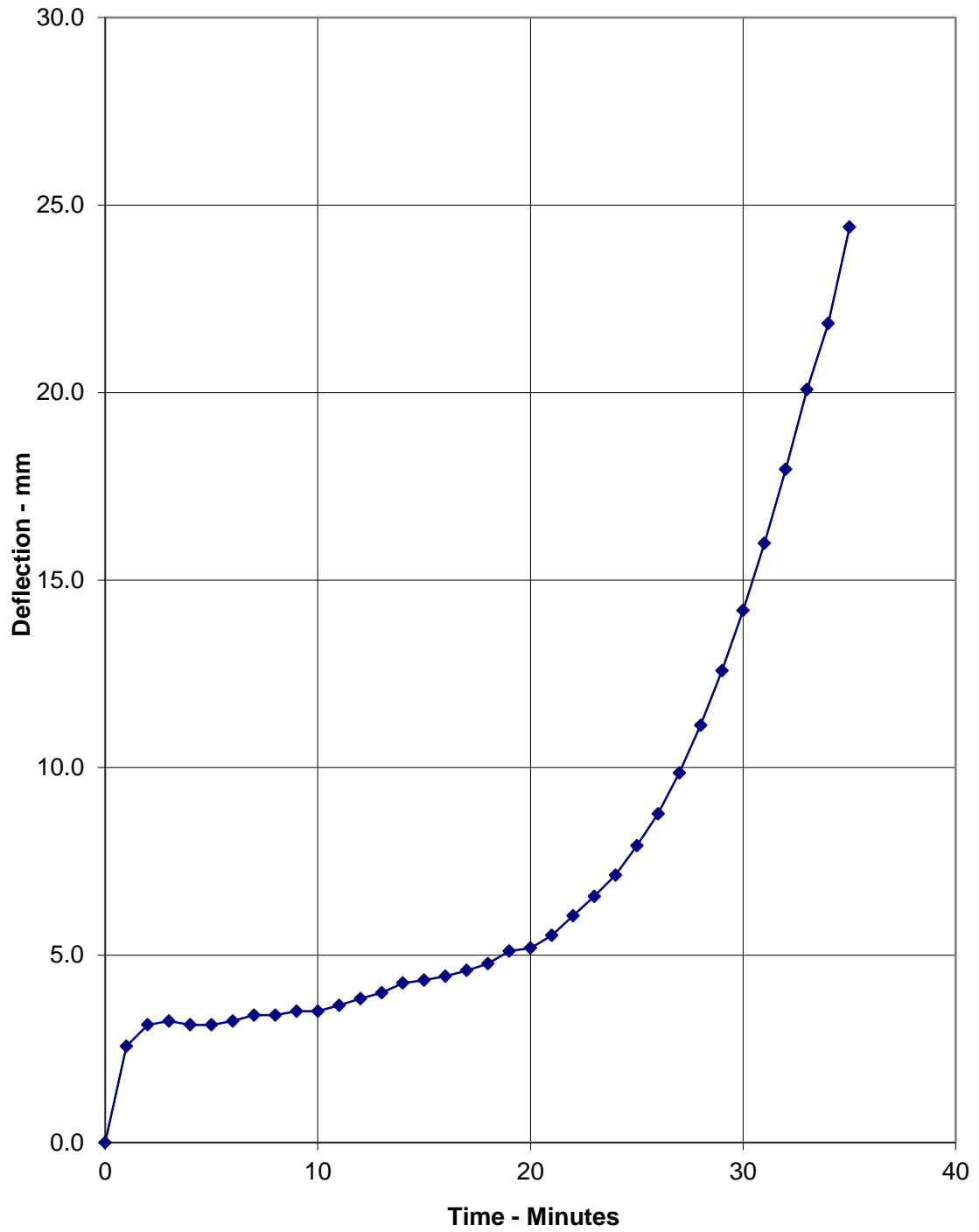
Graph showing the central vertical deflection of the floor assembly during the test

Load Calculations

1. Physical Parameters of Timber Joists

Measured Joist dimensions (d x b)	: 198 mm deep by 46 mm thick
Mean spacing (M)	: 600 mm
Effective span (L)	: 4400 mm
Timber grade of joists	: C16

2. Parameters - BS 5268: Part 2: 1996

Basic dry stress in bending	: 5.3 N/mm ² (Table 7)
Modification factor for loading	: 1.1 (Table 2.9 (a))
Therefore working stress (F)	: 5.83 N/mm ²
Nominal density	: 370 kg/m ³

3. Total Loading Required Per Joist

Moment of Inertia (I)	: $bd^3/12$: $(46 \times 198^3)/12$: 29755836 mm ⁴
Distance from neutral axis to base of joist (y)	: 99 mm
Maximum bending stress	: Fl/y : $(5.83 \times 29755836)/99$: 1752288 N/mm ²
Also maximum bending stress	: $wL^2/8$: 1752288 N/mm ²
Where w	= Load per unit length
∴ w	= $(1752288 \times 8) / (4400 \times 4400)$ = 0.724 N/mm = 724 N/m
∴ Total loading (W)	: 3185.6 N : 324.7 kg

4. Dead Weight

Combined weight of overall specimen:

Actual density of joist	: 360.2 kg/m ³
Actual density of floor boarding	: 652.2 kg/m ³
Actual density of ceiling board	: 930 kg/m ³

Effective width of floor supported per joist (m) : 0.45 m

Weight of joist	: 14.4 kg
Weight of floorboard	: 37.9 kg
Weight of ceiling (3 layers of board)	: 36.8 kg

Total dead weight per joist : 89.1 kg

5. **Imposed Load**

Imposed load per joist required : total load per joist - dead weight per joist
: 324.7 – 89.1
: 235.6 kg

Assuming even distribution of loading

Maximum imposed load per metre square : $(235.6 \times 9.81) / (4.4 \times 0.6)$
: 875.5 N/m²
: **0.876 kN/m²**
: 89.3 kg/m²

Calculation made by



W. Drazkiewicz
Technical Officer
For and on behalf of
Exova Warringtonfire

Checked by



D. Fitzsimmons
Technical Officer
Fire Resistance Department

This copy has been produced from a .pdf format electronic file that has been provided by **Exova Warringtonfire** to the sponsor of the report and must only be reproduced in full. Extracts or abridgements of reports must not be published without permission of **Exova Warringtonfire**. The pdf copy supplied is the sole authentic version of this document. All pdf versions of this report bear authentic signatures of the responsible **Exova Warringtonfire** staff.

Performance Criteria and Test Results

Loadbearing Capacity The limiting deflection and the limiting rate of deflection for the specimen, as specified by the Standard, are calculated as 202 mm and 10.1 mm per minute respectively. The allowable rate of deflection criteria is not applicable for the first 10 minutes of the test. This criterion was satisfied for the 35 minute test duration.

Integrity It is required that specimens retain their separating function, without:

- Causing ignition of a cotton pad when applied
- Permitting the penetration of a gap gauge in the prescribed manner
- Sustained flaming on the unexposed surface
- Integrity failure also occurs simultaneously with loadbearing capacity failure.

These requirements were satisfied for the duration of the test:

Sustained flaming 35 minutes*

Gap gauge 35 minutes*

Cotton pad 35 minutes*

*The test duration. The test was discontinued after a period of 35 minutes

Insulation It is required that the mean temperature rise of the unexposed surface shall not be greater than 140°C and that the maximum temperature rise shall not be greater than 180°C. Insulation failure occurs simultaneously with integrity failure. The insulation requirements were satisfied for the 35 minute test duration.

Ongoing Implications

Limitations This report details the method of construction, the test conditions and the results obtained when the specific element of construction described herein was tested following the procedures outlined in BS EN 1363-1: 2012, and where appropriate BS EN 1363-2: 1999. Any significant deviation with respect to size, constructional details, loads, stresses, edge or end conditions other than those allowed under the field of direct application in the relevant test method is not covered by this report. Annex A of BS EN 1363-1: 2012, provides guidance information on the application of fire resistance tests and the interpretation of test data.

Because of the nature of fire resistance testing and the consequent difficulty in quantifying the uncertainty of measurement of fire resistance, it is not possible to provide a stated degree of accuracy of the result.

Conclusions

Evaluation against objective A specimen of a loadbearing timber floor assembly protected by a direct fix ceiling assembly incorporating twenty three light fittings, has been subjected to a fire resistance test in accordance with the procedures given in BS EN 1365-2:2014. The specimen satisfied the performance requirements for the periods shown below:

Loadbearing capacity		35 minutes*
Integrity performance	Sustained flaming	35 minutes*
	Gap Gauge	35 minutes*
	Cotton pad	35 minutes*
Insulation performance		35 minutes*

*The test was discontinued after a period of 35 minutes

Direct Field Of Application

The results are directly applicable to a similar untested floor construction provided the following is true:

The maximum moments and shear forces, which when calculated on the same basis as the test load, shall not be greater than those tested.

With respect to the ceiling system:

The size of panels of the ceiling lining shall not be changed.

The total area occupied by fixtures and fittings relative to the area of the ceiling lining is not increased and the maximum tested opening in the lining is not exceeded.

With respect to the cavity:

The height of the cavity or cavities is equal to or greater than the height tested.

No combustible or insulating material is added to the cavity unless the same amount (fire load) of combustible or insulating material was included in the test specimen.

Title:

The Fire Resistance Performance of a Loadbearing Timber Floor Assembly Protected by a Plasterboard Ceiling Designed to Provide 60 minutes Fire Resistance, Incorporating Twenty Three Downlight Fittings, When Tested Accordance with BS EN 1365 - 2: 2014

WF Report No: 385024-A



Prepared for:

Integral LED

Unit 6, Iron Bridge Close, Iron Bridge Business Park,
London, NW10 0UF, UK

Date:

26th January 2018

Notified Body No:

0833



0249

This test report is additional to that issued as WF Test report No. 385024 and dated 15th December 2017. The original test report remains valid and is not replaced by this additional test report.

Summary

Objective To determine the fire resistance performance of a loadbearing timber floor assembly protected by a plasterboard ceiling designed to provide 60 minutes fire resistance, incorporating twenty three down light fittings, when tested in accordance with BS EN 1365 - 2: 2014.

Sponsor **Integral LED**
Unit 6, Iron Bridge Close, Iron Bridge Business Park, London, NW10 0UF, UK

Summary of Tested Assembly Briefly, the timber floor had overall nominal dimensions of 4500 mm long by 3000 mm wide and comprised softwood timber joists at 600 mm centres. The upper surface of the floor comprised nominally 22 mm thick tongue and grooved chipboard flooring.

The floor assembly was protected on its underside by a direct fixed ceiling, formed from two layers of 12.5 mm thick British Gypsum Fireline plasterboard, the ceiling was screw fixed to the underside of the floor joists.

The floor supported an evenly distributed load of 0.784 kN/m².

The ceiling incorporated 22 down lighter light fittings, 2 of which are subject to this test report and were referenced as follows:

Test Ref.	Model Ref.	Description
I	ILD LFR70A XXX	Round, fixed, LED recessed downlight
M	ILD LFR92C XXX	Round, tiltable, LED recessed downlight
A-H, J-L and N-W	Items reported separately	

Test Results:

Loadbearing Capacity	66 minutes*
<hr/>	
Integrity Performance	
Sustained flaming	66 minutes*
Gap gauge	66 minutes*
Cotton pad	66 minutes*
<hr/>	
Insulation	66 minutes*

*The test was discontinued after a period of 66 minutes.

Date of Test 24th August 2017

This report may only be reproduced in full. Extracts or abridgements of reports shall not be published without permission of Exova Warringtonfire.

Signatories



Responsible Officer
D. Fitzsimmons*
Technical Officer



Approved
W. Drazkiewicz*
Technical Officer



Head of Department
S. Hankey*
Business Unit Head

* For and on behalf of **Exova Warringtonfire**.

Report Issued

Date : 26th January 2018

This test report is additional to that issued as WF Test report No. 385024 and dated 15th December 2017. The original test report remains valid and is not replaced by this additional test report.

This copy has been produced from a .pdf format electronic file that has been provided by **Exova Warringtonfire** to the sponsor of the report and must only be reproduced in full. Extracts or abridgements of reports must not be published without permission of **Exova Warringtonfire**. The pdf copy supplied is the sole authentic version of this document. All pdf versions of this report bear authentic signatures of the responsible **Exova Warringtonfire** staff.

CONTENTS	PAGE NO.
SUMMARY	2
SIGNATORIES.....	4
TEST PROCEDURE	6
TEST SPECIMEN	7
SCHEDULE OF COMPONENTS	11
INSTRUMENTATION.....	13
TEST OBSERVATIONS	14
TEST PHOTOGRAPHS.....	15
TEMPERATURE & DEFLECTION DATA	18
LOAD CALCULATIONS.....	27
PERFORMANCE CRITERIA AND TEST RESULTS.....	29
ONGOING IMPLICATIONS	29
CONCLUSIONS.....	30
DIRECT FIELD OF APPLICATION	31

Test Procedure

Introduction	<p>The specimen tested was of a loadbearing timber floor construction protected by a direct fix ceiling assembly. The test was conducted in accordance with BS EN 1365-2: 2014, 'Fire resistance tests for loadbearing elements – Part 2: Floors and Roofs'. This test report should be read in conjunction with that Standard and with BS EN 1363-1: 2012, 'Fire resistance tests part 1, general requirements' and BS EN 1363-2: 1999, 'Fire resistance tests part 2, alternative and additional procedures'.</p> <p>The purpose of the test was to evaluate the performance of a timber floor construction protected by a ceiling of known fire resistance, when incorporating down lighter light fitting assemblies.</p> <p>The specimen was judged on its ability to comply with the performance criteria for loadbearing capacity, integrity and insulation, as required by BS EN 1365-2: 2014.</p>
Fire Test Study Group/EGOLF	<p>Certain aspects of some fire test specifications are open to different interpretations. The Fire Test Study Group and EGOLF have identified a number of such areas and have agreed Resolutions which define common agreement of interpretations between fire test laboratories which are members of the Groups. Where such Resolutions are applicable to this test they have been followed.</p>
Instruction To Test	<p>The test was conducted on the 24th August 2017 at the request of Integral LED, the test sponsor.</p>
Test Assembly Construction	<p>A comprehensive description of the test construction is given in the Schedule of Components. The description is based on a detailed survey of the specimen and information supplied by the sponsor of the test.</p>
Installation	<p>Representatives of Exova Warringtonfire assembled the floor construction and installed the downlighters between the 21st and 24th August 2017.</p>
Conditioning	<p>The specimens' storage, construction, and test preparation took place in the test laboratory over a total combined time of 4 days. Throughout this period of time both the temperature and the humidity of the laboratory were measured and recorded as being within a range of from 18°C to 26.5°C and 55.5% to 80% respectively.</p>

Test Specimen

Figure 1- General Elevation of Test Specimen

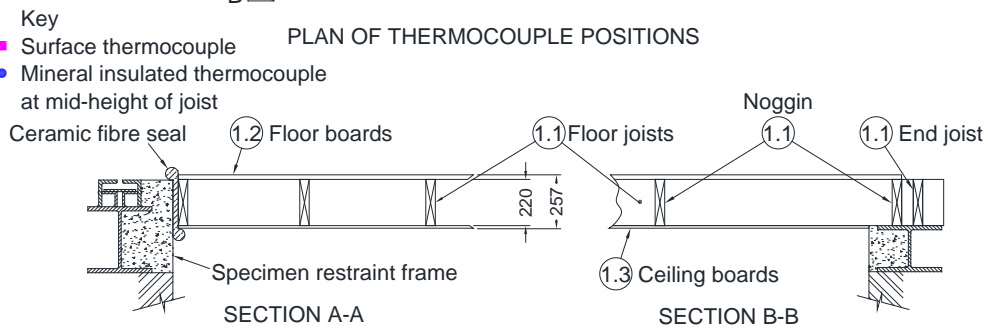
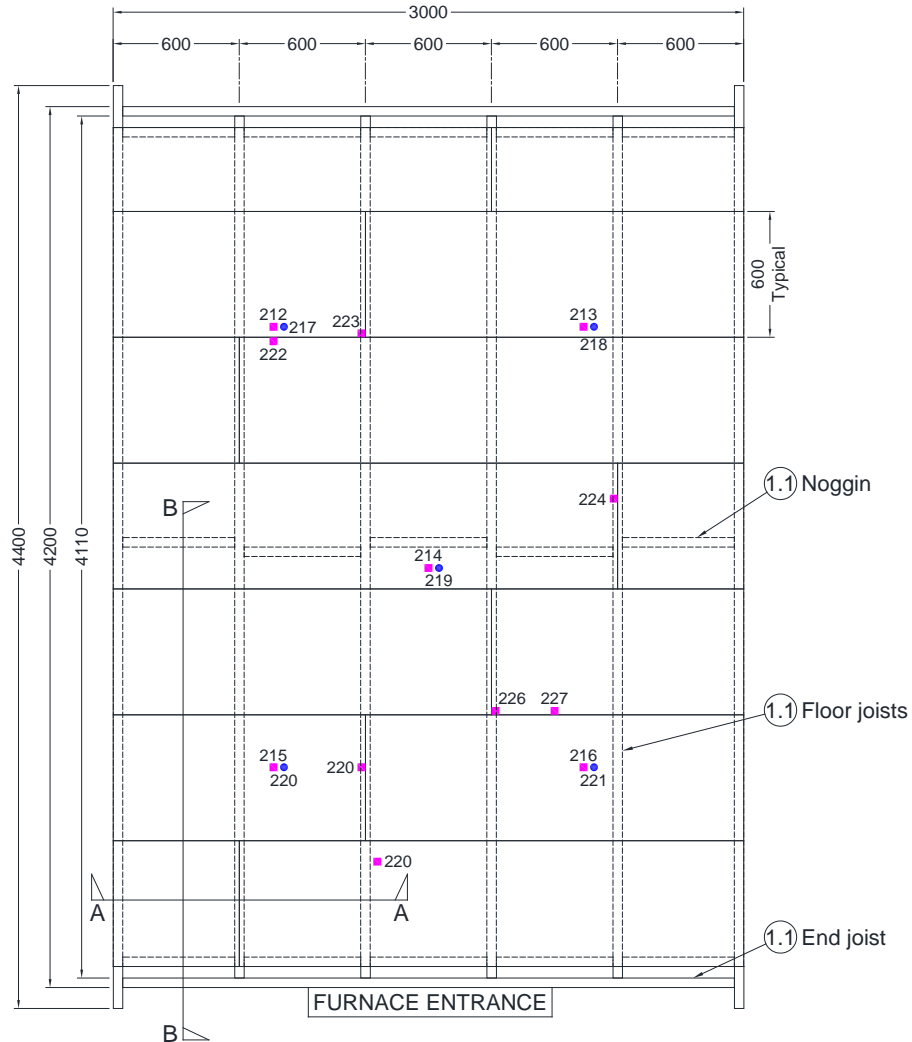

Do not scale. All dimensions are in mm

Figure 2 – Details of Downlighter Positions



Do not scale. All dimensions are in mm

Figure 3 – Details of Downlighters Specimen I

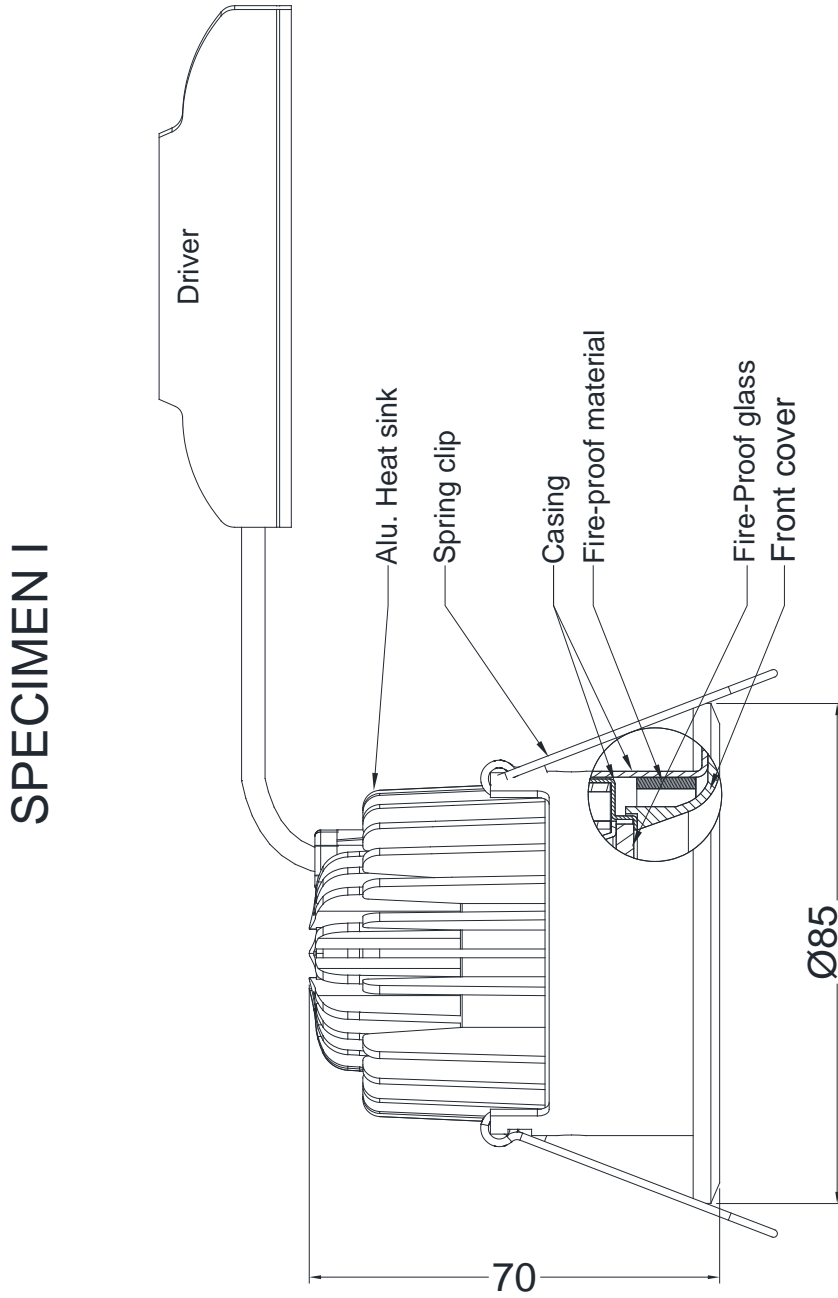

SPECIMEN I

Fixed
With reflector ILDLFR70AXXX
Cut out: Ø70

Do not scale. All dimensions are in mm

Figure 4 – Details of Downlighters Specimen M

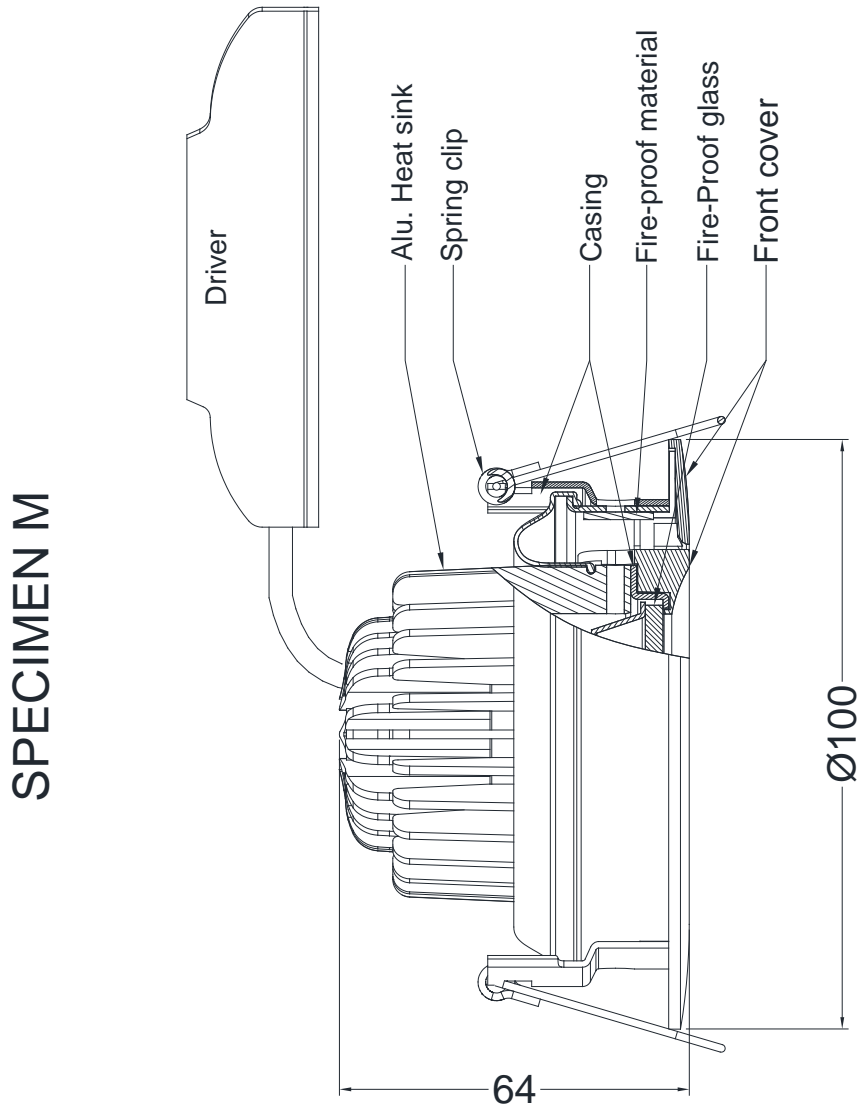

SPECIMEN M

Tilttable
With reflector ILDLFR92CXXX
Cut out: Ø92

Do not scale. All dimensions are in mm

Schedule of Components

(Refer to Figures 1 to 4)

(All values are nominal unless stated otherwise)

(All other details are as stated by the sponsor)

<u>Item</u>	<u>Description</u>
1. Timber Floor	
1.1 Floor Joists	
Material	: British Home-grown, rough sawn softwood, kiln dried
Grade	: C24, to BS EN 519
Density	: 511 kg/m ³
Size	: 45 mm x 197 mm
Joist centres	: 600 mm
1.2 Noggins	
Material	: British Home-grown, rough sawn softwood, kiln dried
Grade	: C24, to BS EN 519
Density	: 511 kg/m ³
Size	: 65 mm x 45 mm
Joist centres	: 1200 mm
1.3 Floor Boards	
Material	: Flooring grade tongue and groove chipboards
Reference	: FSC E1 P5
Thickness	: 22 mm
Size	: 600 mm wide
Fixing	: Fixed in a single layer with 6 mm diameter x 60 mm long countersunk steel screws to floor joists at 300 mm centres
1.4 Ceiling Boards	
Manufacturer	: British Gypsum
Type / reference	: Gyproc Fireline Wallboard
Density	: 803 kg/m ³
Thickness	: 25 mm, 2 layers of 12.5 mm thick
Fixing	
i. method	: The boards were screw fixed to the soffit of the joists with all joints in the second layer staggered with respect to those of the first layer
ii. fixings	: Drywall self drill and tapping screws 38 mm and 50 mm long for the 1 st and 2 nd board layers respectively
iii. frequency	: 150 mm centres along joints and 150 mm to the perimeter of the ceiling

<u>Item</u>	<u>Description</u>
2. Specimen A	: Item reported separately
3. Specimen B	: Item reported separately
4. Specimen C	: Item reported separately
5. Specimen D	: Item reported separately
6. Specimen E	: Item reported separately
7. Specimen F	: Item reported separately
8. Specimen G	: Item reported separately
9. Specimen H	: Item reported separately
10. Specimen I	
Manufacturer	: Integral LED
Type	: Round, fixed, LED recessed downlight
Reference	: ILDLFR70AXXX
Materials	
i. casing	: Mild steel
ii. front cover	: Die cast aluminium
iii. heat sink	: Die cast aluminium
iv. spring clip	: Stainless steel
v. gasket	: 4.3 mm wide x 1.7 mm thick flexible plastics ring
Overall dimensions and construction	: See Figure 11 for details
Cut out size	: 70 mm diameter
Driver	: None
Lamp	: COB
11. Specimen J	: Item reported separately
12. Specimen K	: Item reported separately
13. Specimen L	: Item reported separately
14. Specimen M	
Manufacturer	: Integral LED
Type	: Round, tiltable, LED recessed downlight
Reference	: ILDLFR92CXXX
Materials	
i. casing	: Mild steel
ii. front cover	: Die cast aluminium
iii. heat sink	: Die cast aluminium
iv. spring clip	: Stainless steel
v. gasket	: 4.3 mm wide x 1.7 mm thick flexible plastics ring
Overall dimensions and construction	: See Figure 15 for details
Cut out size	: 92 mm diameter
Driver	: None
Lamp	: COB
15. Specimen N	: Item reported separately
16. Specimen O	: Item reported separately
17. Specimen P	: Item reported separately
18. Specimen Q	: Item reported separately
19. Specimen R	: Item reported separately
20. Specimen S	: Item reported separately
21. Specimen T	: Item reported separately
22. Specimen U	: Item reported separately
23. Specimen V	: Item reported separately
24. Specimen W	: Item reported separately

Instrumentation

General	The instrumentation was provided in accordance with the requirements of the Standard.
Furnace	The furnace was controlled so that its mean temperature complied with the requirements of BS EN 1363-1: 2012, using eight plate thermometers distributed over a plane 100 mm from the underside of the test construction.
Thermocouple Allocation	Thermocouples were provided to monitor the unexposed surface of the floor assembly and the output of all instrumentation was recorded at no less than one minute intervals as follows:
Thermocouples 212 to 216	At five positions on the unexposed surface of the floor assembly, one approximately at the centre and one at approximately the centre of each quarter section.
Thermocouples 222 to 227	At six positions on the unexposed surface of the floor assembly, positioned adjacent to joints in the floor boarding.
Thermocouples 217 to 221	At five positions in the air cavity of the floor assembly, one approximately at the centre and one at approximately the centre of each quarter section The locations and reference numbers of the various unexposed surface and internal thermocouples are shown in Figure 1.
Roving Thermocouple	A roving thermocouple was available to measure temperatures on the unexposed surface of the specimen at any position which might appear to be hotter than the temperatures indicated by the fixed thermocouples.
Furnace Pressure	After the first five minutes of testing and for the remainder of the test. The calculated pressure differential relative to the laboratory atmosphere 100 mm away from the underside of the assembly was 20(+0, -5) Pa between 5 and 10 minutes of testing and 20(+0, -3) Pa after 10 minutes of testing and for the remainder of the test.
Loadbearing Capacity Criteria	Linear deflection transducer was provided at the approximate centre on the unexposed surface of the specimen to record its vertical deflection.
Integrity Criteria	Cotton pads and gap gauges were available to evaluate the integrity of the floor assembly.

Test Observations

Time		All observations are from the unexposed face unless noted otherwise.
mins	secs	The ambient air temperature in the vicinity of the test construction was 24°C at the start of the test with a maximum variation of -1°C during the test.
00	00	The test commences.
08	24	Steam/smoke release is observed from the latitude edges of the specimen.
11	24	When viewed from the exposed face, the paper face of the boards are observed charring away as small hairline cracks begin to form on the boards. All light fittings now appear to have come away from the specimen
18	24	Steam/smoke release observed from the latitude edges increases
21	36	When viewed form the exposed face, gaps are observed forming between the joints of the plasterboard.
51	59	Steam/smoke release observed from latitude edges continues and slowly increases.
60	00	When viewed form the exposed face, the gaps between the joints of plasterboard are observed continuing to expand..
66	00	The test is discontinued.

Test Photographs

The exposed face of the assembly prior to the start of the test



The unexposed face of the assembly prior to the start of the test



The unexposed face of the assembly after 20 minutes of testing



The unexposed surface of the assembly after a test duration of 50 minutes



The unexposed surface of the assembly after a test duration of 66 minutes



Temperature & Deflection Data

Mean furnace temperature, together with the temperature/time relationship specified in the Standard

Time Mins	Specified Furnace Temperature Deg. C	Actual Furnace Temperature Deg. C
0	20	30
2	445	349
4	544	501
6	603	620
8	646	672
10	678	676
12	706	719
14	728	727
16	748	746
18	766	759
20	781	786
22	796	800
24	809	813
26	820	825
28	832	833
30	842	843
32	852	851
34	860	859
36	869	866
38	877	873
40	885	881
42	892	887
44	899	895
46	906	902
48	912	908
50	918	915
52	924	923
54	930	932
56	935	934
58	940	940
60	945	946
62	950	952
64	955	957
66	960	963

Individual and mean temperatures recorded on the unexposed surface of the floor assembly

Time Mins	T/C Number 212 Deg. C	T/C Number 213 Deg. C	T/C Number 214 Deg. C	T/C Number 215 Deg. C	T/C Number 216 Deg. C	Mean Temp Deg. C
0	24	24	24	22	22	23
2	24	24	24	22	22	23
4	24	24	24	22	22	23
6	24	24	24	22	22	23
8	24	24	24	22	22	23
10	24	24	24	22	22	23
12	25	25	25	23	23	24
14	25	26	26	24	23	25
16	27	27	27	25	25	26
18	28	29	29	27	26	28
20	30	30	30	28	28	29
22	31	32	32	30	30	31
24	32	34	33	32	32	33
26	34	35	34	33	34	34
28	35	37	36	35	36	36
30	36	38	37	37	38	37
32	38	39	38	39	40	39
34	39	40	40	40	42	40
36	40	42	41	42	44	42
38	41	43	42	44	46	43
40	42	44	43	45	47	44
42	43	45	44	47	49	46
44	43	45	45	48	50	46
46	44	46	46	50	51	47
48	45	47	46	51	52	48
50	46	48	48	52	53	49
52	46	49	49	54	55	51
54	47	51	50	56	56	52
56	49	53	52	59	59	54
58	51	57	54	62	62	57
60	54	61	57	65	64	60
62	57	65	59	67	67	63
64	61	68	62	69	70	66
66	64	71	64	71	71	68

Individual temperatures recorded adjacent to joints in the flooring

Time	T/C	T/C	T/C	T/C	T/C	T/C
Mins	Number	Number	Number	Number	Number	Number
	222	223	224	225	226	227
	Deg. C	Deg. C	Deg. C	Deg. C	Deg. C	Deg. C
0	22	21	21	21	22	35
2	22	21	21	21	22	35
4	22	21	21	21	22	36
6	22	21	21	22	22	36
8	22	22	21	22	22	36
10	22	22	21	22	23	36
12	22	22	21	22	23	36
14	23	23	21	22	24	37
16	25	25	22	23	25	39
18	26	27	22	24	27	40
20	28	30	22	25	28	42
22	29	33	23	27	30	44
24	31	36	23	28	31	46
26	33	39	24	29	33	48
28	35	43	25	31	35	50
30	36	45	25	32	36	49
32	38	48	26	33	38	45
34	40	50	27	35	39	43
36	41	52	27	36	41	49
38	43	54	28	37	43	55
40	44	55	28	38	44	43
42	45	56	29	39	45	57
44	47	57	29	40	46	58
46	48	58	29	41	47	59
48	49	59	30	43	48	59
50	51	60	30	43	49	59
52	53	61	30	45	50	59
54	55	63	30	46	51	59
56	57	64	31	47	52	59
58	60	66	32	50	55	60
60	63	67	32	52	57	60
62	66	68	31	56	60	59
64	69	70	28	61	63	57
66	72	71	27	66	65	63

Individual temperatures recorded in the air cavity

Time Mins	T/C Number 217 Deg. C	T/C Number 218 Deg. C	T/C Number 219 Deg. C	T/C Number 220 Deg. C	T/C Number 221 Deg. C	Mean Temp Deg. C
0	23	23	23	25	24	24
2	23	24	23	25	24	24
4	23	24	23	25	24	24
6	24	24	23	25	25	24
8	25	26	25	27	26	26
10	29	30	28	30	30	29
12	33	36	32	34	34	34
14	37	41	36	39	38	38
16	42	46	40	43	42	43
18	45	50	43	46	45	46
20	49	53	46	49	49	49
22	52	56	49	53	52	52
24	55	58	52	56	55	55
26	57	60	54	59	58	58
28	60	62	56	61	60	60
30	62	64	58	65	62	62
32	64	66	60	67	64	64
34	66	67	62	70	66	66
36	67	68	63	72	68	68
38	68	70	65	74	69	69
40	69	71	66	76	71	71
42	70	72	67	77	72	72
44	71	73	69	79	74	73
46	72	75	70	80	75	74
48	74	78	73	82	76	77
50	76	85	77	86	79	81
52	80	92	80	90	83	85
54	87	96	85	93	87	90
56	94	97	89	95	90	93
58	96	98	92	95	93	95
60	96	98	94	95	94	95
62	96	99	96	95	95	96
64	96	100	97	95	96	97
66	96	101	97	95	96	97

Deflection of the floor assembly during the test

Time Mins	Central Vertical Deflection mm	Rate Of Deflection mm/min
0	0.0	0
2	2.1	0.6
4	2.4	0.1
6	2.4	0.0
8	2.4	0.1
10	2.6	0.2
12	3.1	0.2
14	3.5	0.2
16	4.1	0.2
18	4.3	0.1
20	4.7	0.2
22	5.2	0.2
24	5.8	0.2
26	6.2	0.2
28	6.5	0.1
30	7.0	0.3
32	7.1	0.1
34	7.5	0.2
36	7.9	0.2
38	8.1	0.1
40	8.4	0.1
42	8.7	0.1
44	9.1	0.2
46	9.3	0.1
48	9.6	0.2
50	10.1	0.3
52	10.7	0.4
54	11.5	0.4
56	12.5	0.6
58	13.8	0.8
60	15.2	0.8
62	16.8	0.9
64	18.5	1.0
66	20.5	0.9

Recorded Furnace 100 mm below the floor assembly

Time Mins	Recorded Pressure Pascals
0	-50
2	-50
4	-50
6	-15.8
8	15.9
10	14.2
12	17.1
14	14.9
16	18.5
18	16.6
20	17.8
22	19.5
24	21.3
26	19.2
28	17.9
30	18.6
32	20.1
34	18.4
36	18.5
38	18
40	17.5
42	18.3
44	20.1
46	20.1
48	21.2
50	21
52	17.5
54	18.9
56	17.4
58	17.9
60	19.2
62	18.7
64	18.3
66	17.1

Graph showing specified and actual furnace temperatures

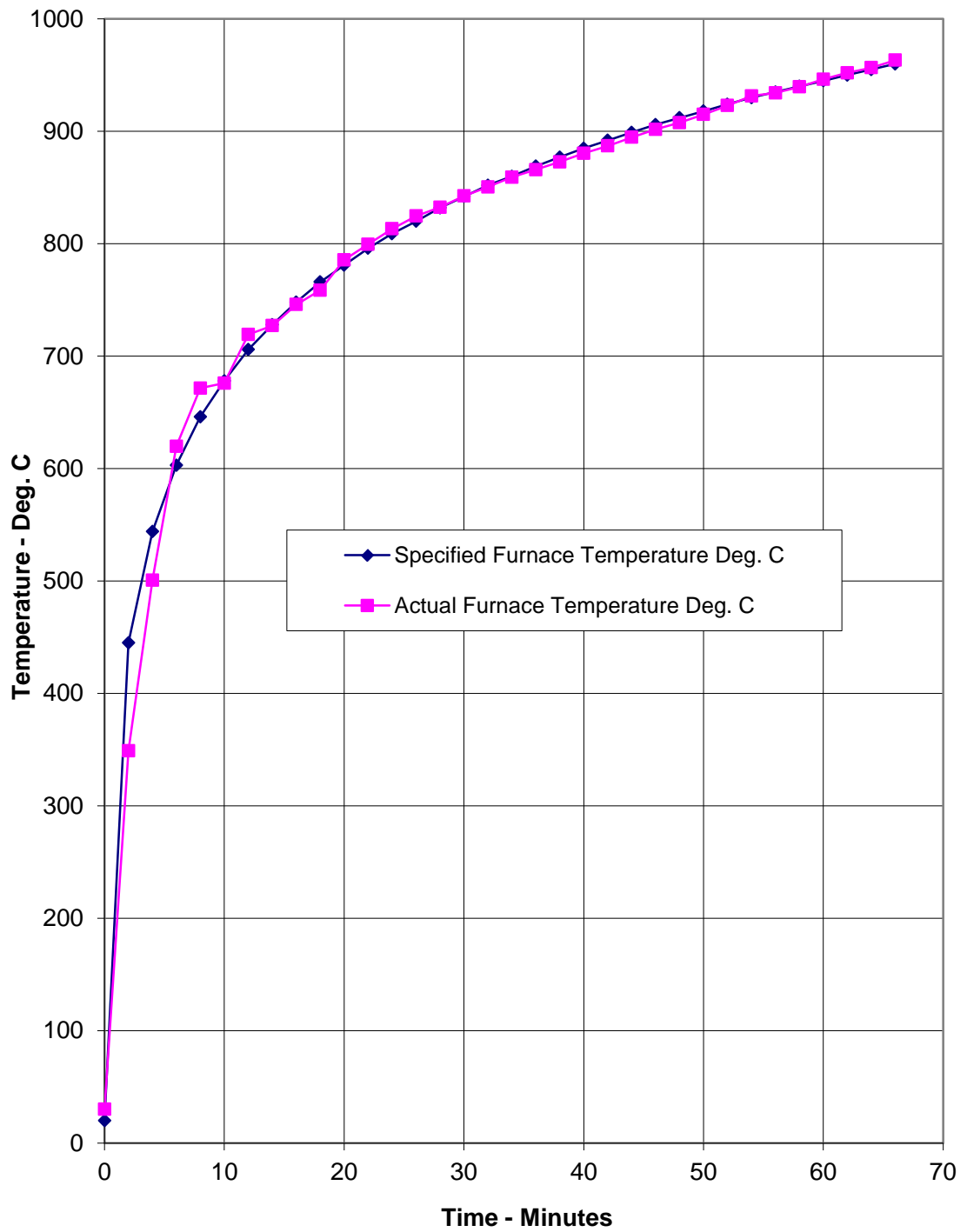

Graph showing mean unexposed surface temperature of the floor assembly

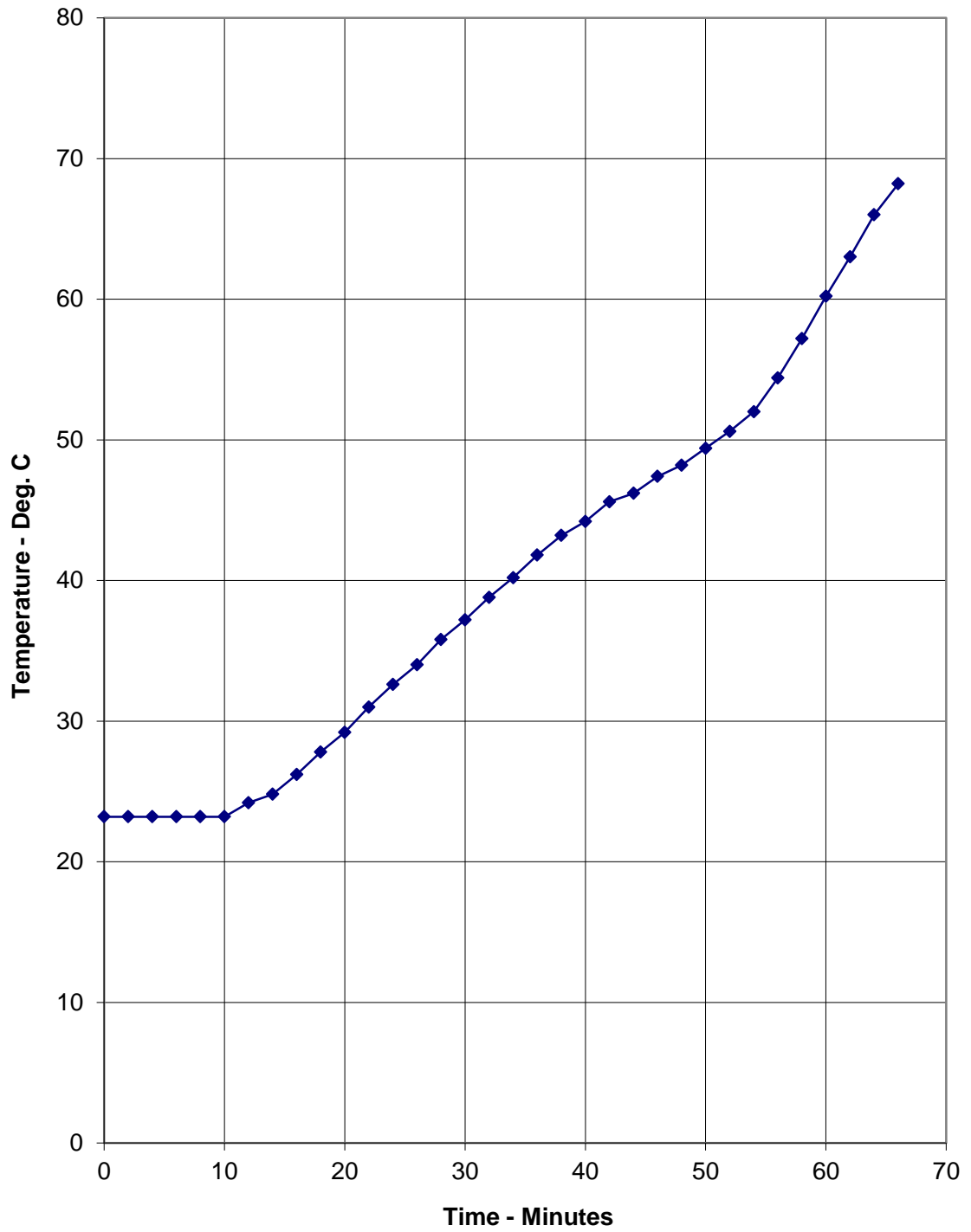

Graph showing the central vertical deflection of the floor assembly during the test

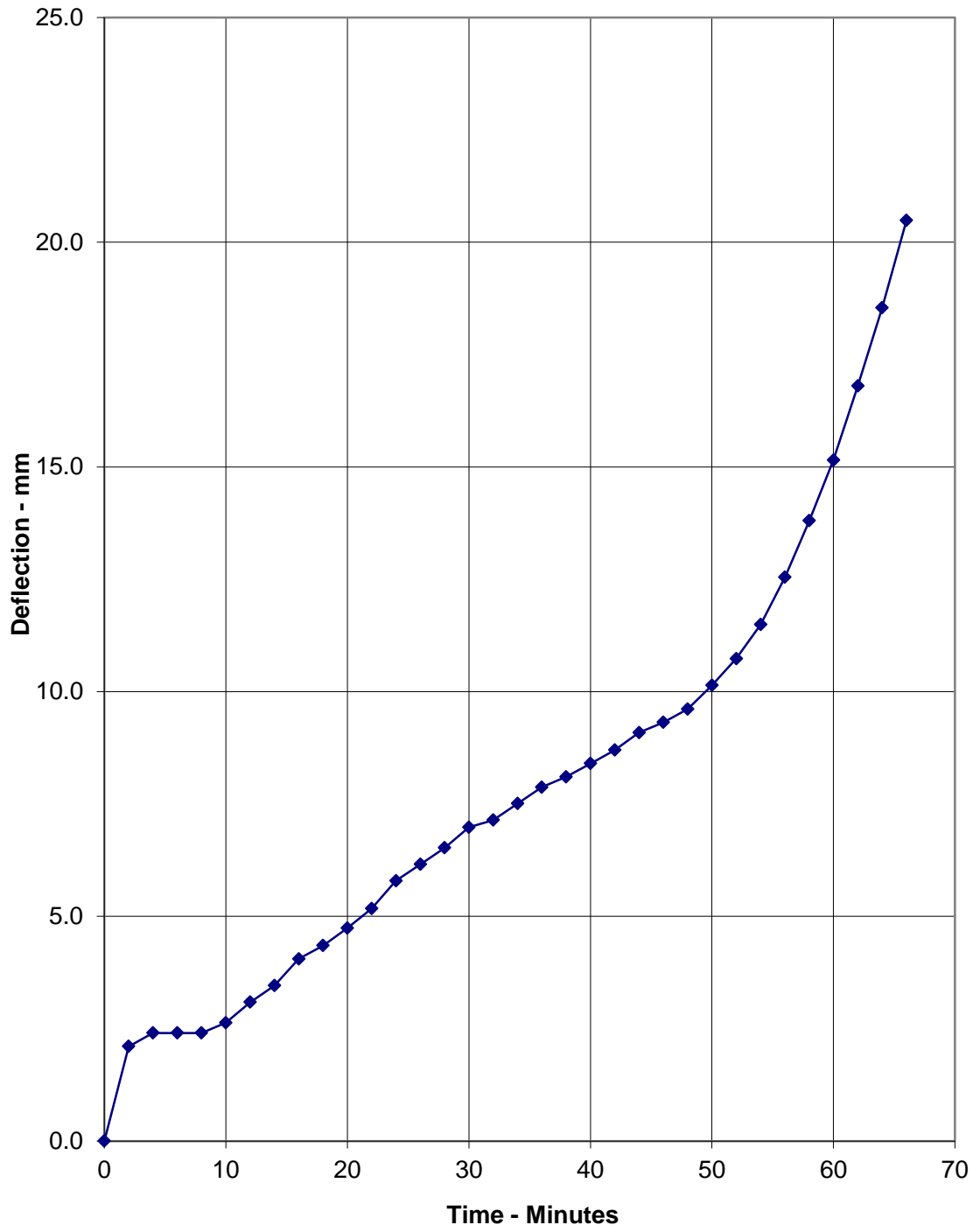

Load Calculations

1. Physical Parameters of Timber Joists

Measured Joist dimensions (d x b)	: 198 mm deep by 46 mm thick
Mean spacing (M)	: 600 mm
Effective span (L)	: 4400 mm
Timber grade of joists	: C16

2. Parameters - BS 5268: Part 2: 1996

Basic dry stress in bending	: 5.3 N/mm ² (Table 7)
Modification factor for loading	: 1.1 (Table 2.9 (a))
Therefore working stress (F)	: 5.83 N/mm ²
Nominal density	: 370 kg/m ³

3. Total Loading Required Per Joist

Moment of Inertia (I)	: $bd^3/12$: $(46 \times 198^3)/12$: 29755836 mm ⁴
Distance from neutral axis to base of joist (y)	: 99 mm
Maximum bending stress	: Fl/y : $(5.83 \times 29755836)/99$: 1752288 N/mm ²
Also maximum bending stress	: $wL^2/8$: 1752288 N/mm ²
Where w	= Load per unit length
∴ w	= $(1752288 \times 8) / (4400 \times 4400)$ = 0.724 N/mm = 724 N/m
∴ Total loading (W)	: 3185.6 N : 324.7 kg

4. Dead Weight

Combined weight of overall specimen:

Actual density of joist	: 360.2 kg/m ³
Actual density of floor boarding	: 652.2 kg/m ³
Actual density of ceiling board	: 930 kg/m ³

Effective width of floor supported per joist (m) : 0.45 m

Weight of joist	: 14.4 kg
Weight of floorboard	: 37.9 kg
Weight of ceiling (3 layers of board)	: 61.0 kg

Total dead weight per joist : 113.7 kg

5. **Imposed Load**

Imposed load per joist required : total load per joist - dead weight per joist
: 324.7 – 113.7
: 211 kg

Assuming even distribution of loading

Maximum imposed load per metre square : $(235.6 \times 9.81) / (4.4 \times 0.6)$
: 784.1 N/m²
: **0.784 kN/m²**
: 80 kg/m²

Calculation made by



W. Drazkiewicz
Technical Officer
For and on behalf of
Exova Warringtonfire

Checked by



D. Fitzsimmons
Technical Officer
Fire Resistance Department

This copy has been produced from a .pdf format electronic file that has been provided by **Exova Warringtonfire** to the sponsor of the report and must only be reproduced in full. Extracts or abridgements of reports must not be published without permission of **Exova Warringtonfire**. The pdf copy supplied is the sole authentic version of this document. All pdf versions of this report bear authentic signatures of the responsible **Exova Warringtonfire** staff.

Performance Criteria and Test Results

Loadbearing Capacity The limiting deflection and the limiting rate of deflection for the specimen, as specified by the Standard, are calculated as 202 mm and 10.1 mm per minute respectively. The allowable rate of deflection criteria is not applicable for the first 10 minutes of the test. This criterion was satisfied for the 66 minute test duration.

Integrity It is required that specimens retain their separating function, without:

- Causing ignition of a cotton pad when applied
- Permitting the penetration of a gap gauge in the prescribed manner
- Sustained flaming on the unexposed surface
- Integrity failure also occurs simultaneously with loadbearing capacity failure.

These requirements were satisfied for the duration of the test:

Sustained flaming 66 minutes*

Gap gauge 66 minutes*

Cotton pad 66 minutes*

*The test duration. The test was discontinued after a period of 66 minutes

Insulation It is required that the mean temperature rise of the unexposed surface shall not be greater than 140°C and that the maximum temperature rise shall not be greater than 180°C. Insulation failure occurs simultaneously with integrity failure. The insulation requirements were satisfied for the 66 minute test duration.

Ongoing Implications

Limitations This report details the method of construction, the test conditions and the results obtained when the specific element of construction described herein was tested following the procedures outlined in BS EN 1363-1: 2012, and where appropriate BS EN 1363-2: 1999. Any significant deviation with respect to size, constructional details, loads, stresses, edge or end conditions other than those allowed under the field of direct application in the relevant test method is not covered by this report. Annex A of BS EN 1363-1: 2012, provides guidance information on the application of fire resistance tests and the interpretation of test data.

Because of the nature of fire resistance testing and the consequent difficulty in quantifying the uncertainty of measurement of fire resistance, it is not possible to provide a stated degree of accuracy of the result.

Conclusions

Evaluation against objective A specimen of a loadbearing timber floor assembly protected by a direct fix ceiling assembly incorporating twenty three light fittings, has been subjected to a fire resistance test in accordance with the procedures given in BS EN 1365-2:2014. The specimen satisfied the performance requirements for the periods shown below:

Loadbearing capacity		66 minutes*
-----------------------------	--	-------------

Integrity performance	Sustained flaming	66 minutes*
------------------------------	-------------------	-------------

Gap Gauge	66 minutes*
-----------	-------------

Cotton pad	66 minutes*
------------	-------------

Insulation performance		66 minutes*
-------------------------------	--	-------------

*The test was discontinued after a period of 66 minutes

Direct Field Of Application

The results are directly applicable to a similar untested floor construction provided the following is true:

The maximum moments and shear forces, which when calculated on the same basis as the test load, shall not be greater than those tested.

With respect to the ceiling system:

The size of panels of the ceiling lining shall not be changed.

The total area occupied by fixtures and fittings relative to the area of the ceiling lining is not increased and the maximum tested opening in the lining is not exceeded.

With respect to the cavity:

The height of the cavity or cavities is equal to or greater than the height tested.

No combustible or insulating material is added to the cavity unless the same amount (fire load) of combustible or insulating material was included in the test specimen.

Title:

The Fire Resistance Performance of a Specimen of a Loadbearing Timber Floor Assembly Protected by a Plasterboard Ceiling Designed to Provide 90 minutes Fire Resistance, Incorporating Sixteen Downlight Light Fittings, Tested in Accordance with BS 476: Part 21: 1987, Clause 7

WF Report No:

388542A Issue 2



Prepared for:

Integral LED
Unit 6, Iron Bridge Close, Iron
Bridge Business Park,
London, NW10 0UF, UK

Date:

26th January 2018

Notified Body No:

0833



0249

This test report is additional to that issued as WF Test report No. 388542 and dated 15th December 2017. The original test report remains valid and is not replaced by this additional test report.

Summary

Objective To determine the fire resistance performance of a loadbearing timber floor assembly protected by a plasterboard ceiling designed to provide 90 minutes fire resistance, incorporating sixteen downlight light fittings, when tested in accordance with Clause 7 of BS 476: Part 21: 1987.

Sponsor **Integral LED**
Unit 6, Iron Bridge Close, Iron Bridge Business Park, London, NW10 0UF,

Summary of Tested Assembly Briefly, the timber floor had overall nominal dimensions of 4400 mm long by 3000 mm wide and comprised softwood timber joists at 600 mm centres. The upper surface of the floor comprised nominally 22 mm thick tongue and grooved chipboard flooring.

The floor assembly was protected on its underside by a direct fixed ceiling, formed from two layers of 15 mm thick British Gypsum Fireline plasterboard, the ceiling was screw fixed to the underside of the floor joists.

The floor supported an evenly distributed load of 0.822 kN/m².

The ceiling incorporated sixteen downlight light fittings, two of which are subject to this test report and were referenced as follows:

Test Ref.	Model Ref.	Description
K	ILDIFR92CXXX	Round LED recessed down light, 92 mm diameter cut-out
M	ILDIFR70AXXX	Round LED recessed down light, 70 mm diameter cut-out
A – J, L and N - P	Items reported separately	

Test Results:

Loadbearing Capacity	93 minutes*
Integrity	93 minutes*
Insulation	93 minutes*

*The test was discontinued after a period of 93 minutes

Date of Test 16th September 2017

This report may only be reproduced in full. Extracts or abridgements of reports shall not be published without permission of Warringtonfire. All work and services carried out by Warringtonfire Testing and Certification Limited are subject to, and conducted in accordance with, the Standard Terms and Conditions of Warringtonfire Testing and Certification Limited, which are available at <https://www.element.com/terms/terms-and-conditions> or upon request.

Signatories



Responsible Officer
W. Drazkiewicz*
Technical Officer

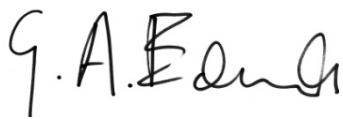

Approved
G. Edmonds*
Senior Technical Officer

* For and on behalf of **Warringtonfire**.

Report Issued
Date: 26th January 2018

This test report is additional to that issued as WF Test report No. 388542 and dated 15th December 2017. The original test report remains valid and is not replaced by this additional test report.

This copy has been produced from a .pdf format electronic file that has been provided by **Warringtonfire** to the sponsor of the report and must only be reproduced in full. Extracts or abridgements of reports must not be published without permission of **Warringtonfire**. The pdf copy supplied is the sole authentic version of this document. All pdf versions of this report bear authentic signatures of the responsible **Warringtonfire** staff.

Revision History

Issue No: 2	Re-issue Date: 16 th December 2019
Revised By: D. Whittle	Approved By: W. Drazkiewicz
Reason for Revision: Rebranding of report and amendment to details of Specimen M	

Issue No :	Re-issue Date:
Revised By:	Approved By:
Reason for Revision:	

CONTENTS	PAGE NO.
SUMMARY	2
SIGNATORIES.....	4
REVISION HISTORY	5
TEST PROCEDURE	7
TEST CONSTRUCTION	8
SCHEDULE OF COMPONENTS	12
INSTRUMENTATION.....	14
TEST OBSERVATIONS	15
TEST PHOTOGRAPHS.....	17
TEMPERATURE & DEFLECTION DATA.....	19
LOAD CALCULATIONS.....	28
PERFORMANCE CRITERIA AND TEST RESULTS.....	30
ONGOING IMPLICATIONS	30
CONCLUSIONS.....	31

Test Procedure

Introduction	<p>The specimen tested was of a loadbearing construction. The test was conducted in accordance with Clause 7 of BS 476: Part 21: 1987, 'Methods for determination of the fire resistance of loadbearing elements of construction'. This test report should be read in conjunction with that Standard and with BS 476: Part 20: 1987, 'Method for determination of the fire resistance of elements of construction (general principles)'.</p> <p>The purpose of the test was to evaluate the performance of a timber floor construction protected by a ceiling of previously proven fire resistance, when incorporating down lighter fitting assemblies.</p> <p>The specimen was judged on its ability to comply with the performance criteria for loadbearing capacity, integrity and insulation, as required by BS 476: Part 21: 1987, Clause 7.</p>
Fire Test Study Group/EGOLF	<p>Certain aspects of some fire test specifications are open to different interpretations. The Fire Test Study Group and EGOLF have identified a number of such areas and have agreed Resolutions which define common agreement of interpretations between fire test laboratories which are members of the Groups. Where such Resolutions are applicable to this test they have been followed.</p>
Instruction To Test	<p>The test was conducted on the 16th September 2017 at the request of Integral LED, the test sponsor.</p>
Test Assembly Construction	<p>A comprehensive description of the test construction is given in the Schedule of Components. The description is based on a detailed survey of the specimens and information supplied by the sponsor of the test.</p>
Installation	<p>Representatives of Warringtonfire assembled the floor construction and installed the down lighters on the 14th September 2017</p>
Conditioning	<p>The floor construction and downlighters specimens' storage, construction, and test preparation took place in the test laboratory over a total combined time of 5 days. Throughout this period of time both the temperature and the humidity of the laboratory were measured and recorded as being within a range of from 9°C to 13°C and 50% to 62% respectively.</p>

Test Construction

Figure 1- General Elevation of Test Construction

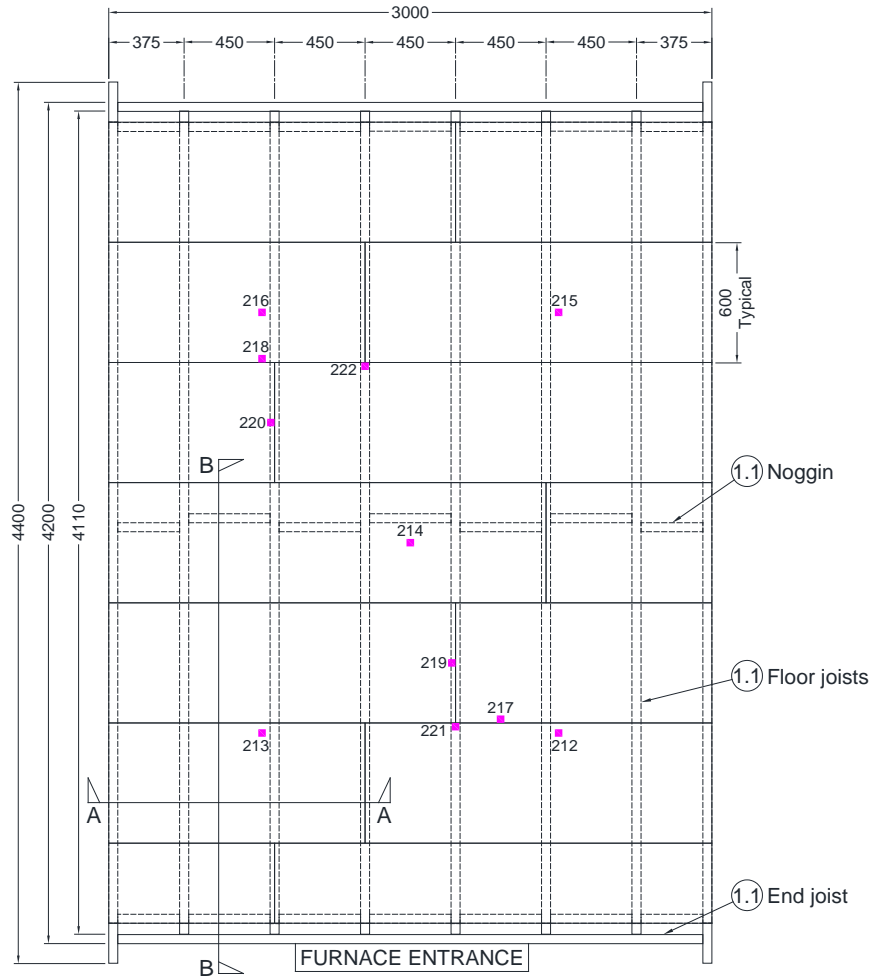

Key
 ■ Surface thermocouple

PLAN OF THERMOCOUPLE POSITIONS

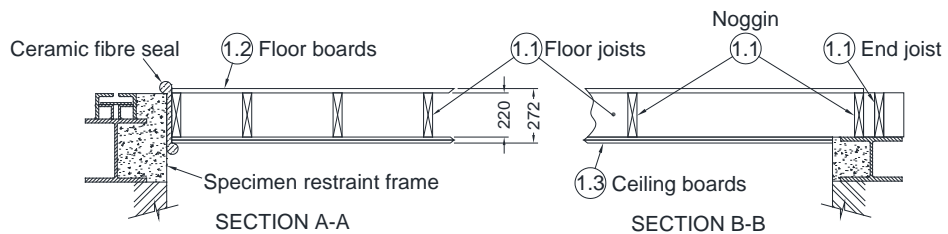

Do not scale. All dimensions are in mm

Figure 2 – Details of Downlighter Positions

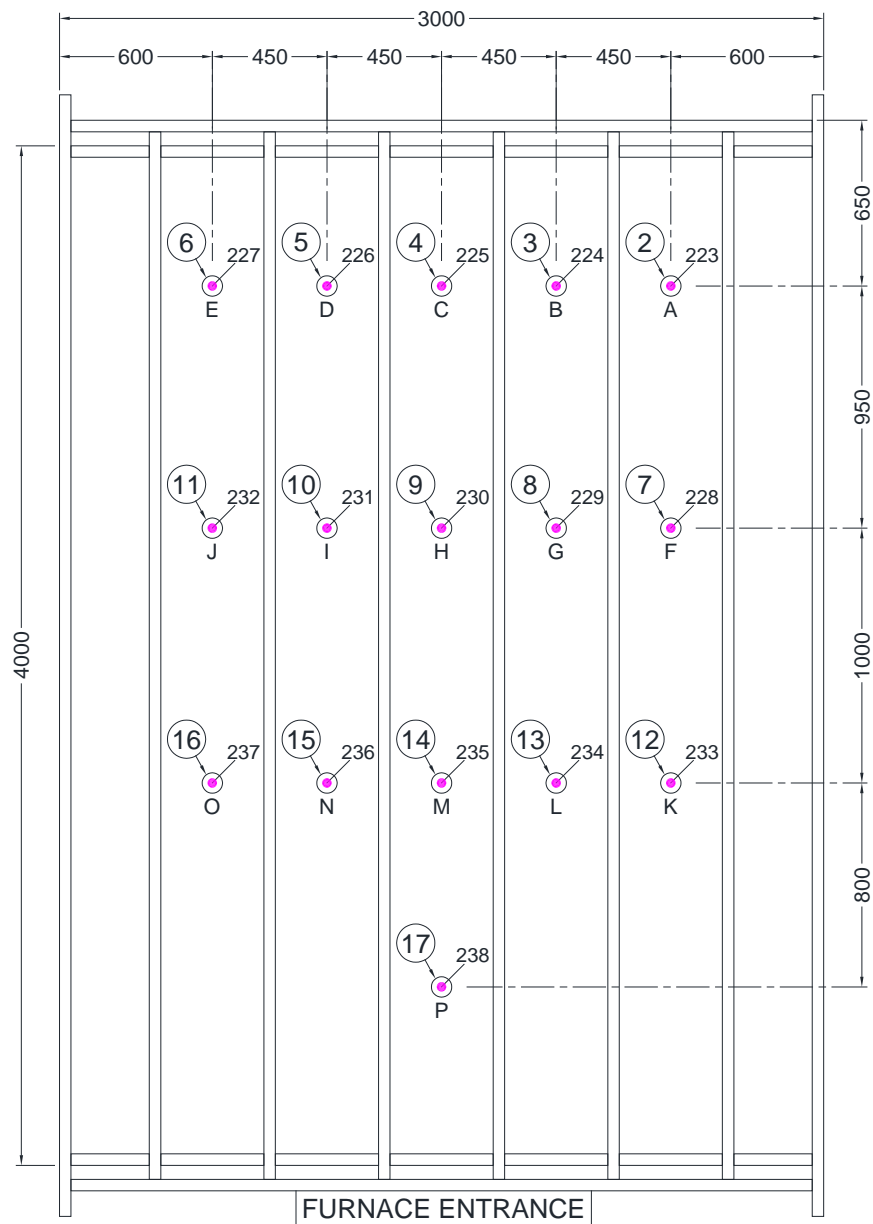

● Mineral insulated thermocouples at mid-cavity height

Do not scale. All dimensions are in mm

Figure 3 – Details of Downlighters Specimen K

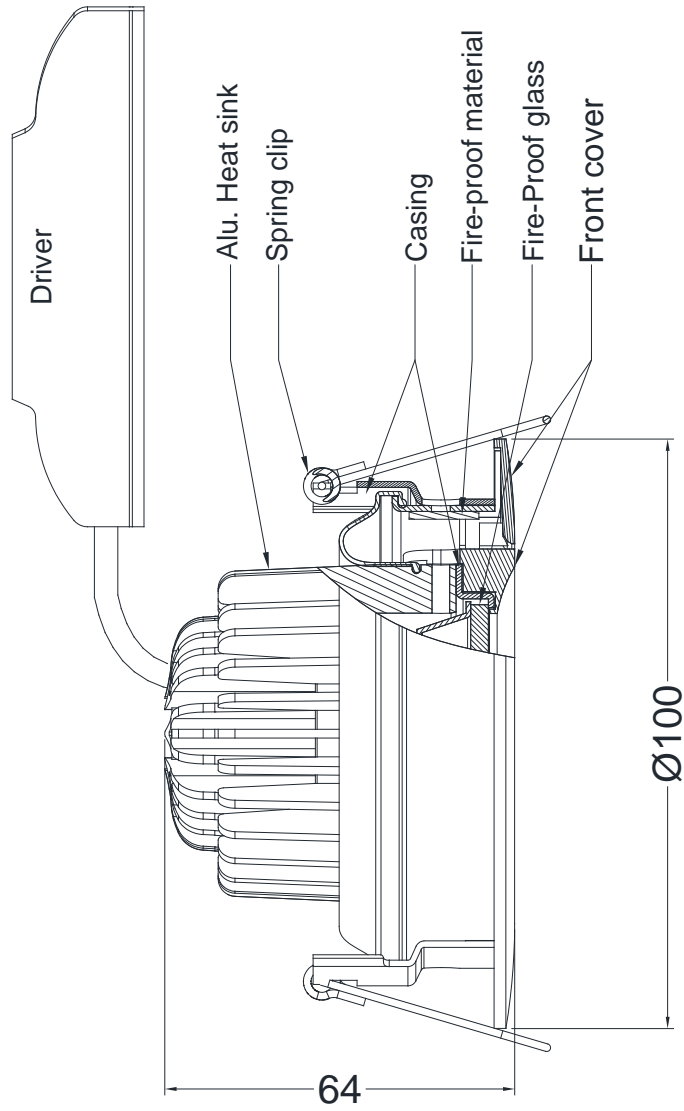

Tilttable
With reflector ILDLFR92CXXX
Cut out: $\varnothing 92$

Do not scale. All dimensions are in mm

Figure 4 – Details of Downlighters Specimen M

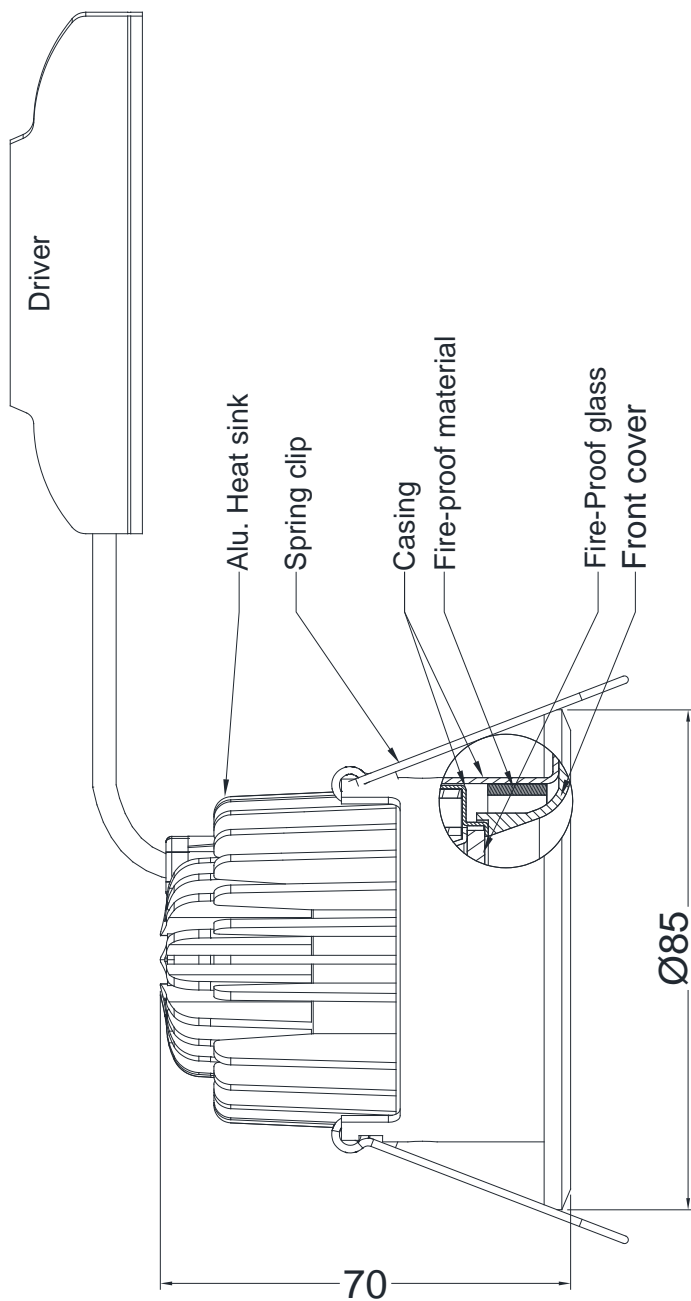

Fixed
With reflector ILDLFR70AXXX
Cut out: Ø70

Do not scale. All dimensions are in mm

Schedule of Components

(Refer to Figures 1 to 4)
 (All values are nominal unless stated otherwise)
 (All other details are as stated by the sponsor)

<u>Item</u>	<u>Description</u>
1. Timber Floor	
1.1 Floor Joists	
Material	: British Home-grown, rough sawn softwood, kiln dried
Grade	: C16, to BS EN 519
Density	: 511 kg/m ³
Size	: 45 mm x 197 mm
Joist centres	: 450 mm
1.2 Noggins	
Material	: British Home-grown, rough sawn softwood, kiln dried
Grade	: C24, to BS EN 519
Density	: 511 kg/m ³
Size	: 65 mm x 45 mm
Joist centres	: 1200 mm
1.2 Floor Boards	
Material	: Flooring grade tongue and groove chipboards
Reference	: FSC E1 P5
Thickness	: 22 mm
Size	: 450 mm wide
Fixing	: Fixed in a single layer with 6 mm diameter x 60 mm long countersunk steel screws to floor joists at 300 mm centres
1.3 Ceiling Boards	
Manufacturer	: British Gypsum
Type / reference	: Gyproc Fireline Wallboard
Density	: 803 kg/m ³
Thickness	: 30 mm, 2 layers of 15 mm thick
Fixing	
i. method	: The boards were screw fixed to the soffit of the joists with all joints in the second layer staggered with respect to those of the first layer
ii. fixings	: Drywall self drill and tapping screws 38 mm and 50 mm long for the 1 st and 2 nd board layers respectively
iii. frequency	: 150 mm centres along joints and 150 mm to the perimeter of the ceiling

<u>Item</u>	<u>Description</u>
2. Specimen A	: Item reported separately
3. Specimen B	: Item reported separately
4. Specimen C	: Item reported separately
5. Specimen D	: Item reported separately
6. Specimen E	: Item reported separately
7. Specimen F	: Item reported separately
8. Specimen G	: Item reported separately
9. Specimen H	: Item reported separately
10. Specimen I	: Item reported separately
11. Specimen J	: Item reported separately
12. Specimen K	
Manufacturer	: Integral LED
Type	: Round, tiltable, LED recessed downlight
Reference	: ILDLFR92CXXX
Materials	
i. casing	: Mild steel
ii. front cover	: Die cast aluminium
iii. heat sink	: Die cast aluminium
iv. spring clip	: Stainless steel
v. gasket	: 4.3 mm wide x 1.7 mm thick flexible plastics ring
Overall dimensions and construction	: See Figure 13 for details
Cut out size	: 92 mm diameter
Driver	: None
Lamp	: COB
14. Specimen M	
Manufacturer	: Integral LED
Type	: Round, fixed, LED recessed downlight
Reference	: ILDLFR70AXXX
Materials	
i. casing	: Mild steel
ii. front cover	: Die cast aluminium
iii. heat sink	: Die cast aluminium
iv. spring clip	: Stainless steel
v. gasket	: 4.3 mm wide x 1.7 mm thick flexible plastics ring
Overall dimensions and construction	: See Figure 15 for details
Cut out size	: 70 mm diameter
Driver	: None
Lamp	: COB
15. Specimen N	: Item reported separately
16. Specimen O	: Item reported separately
17. Specimen P	: Item reported separately

Instrumentation

General	The instrumentation was provided in accordance with the requirements of the Standard.
Furnace	The furnace was controlled so that its mean temperature complied with the requirements of BS 476: Part 20: 1987, Clause 3.1. using eight mineral insulated thermocouples distributed over a plane 100 mm from the underside of the ceiling.
Thermocouple Allocation	<p>Thermocouples were provided to monitor the unexposed surface of the floor assembly and the output of all instrumentation was recorded at no less than one minute intervals as follows:</p> <p>The locations and reference numbers of the various unexposed surface and internal thermocouples are shown in Figures 1 and 2.</p>
Roving Thermocouple	A roving thermocouple was available to measure temperatures on the unexposed surface of the floor at any position which might appear to be hotter than the temperatures indicated by the fixed thermocouples.
Integrity criteria	Cotton pads and gap gauges were available to evaluate the impermeability of the test construction to hot gases.
Furnace Pressure	After the first five minutes of testing and for the remainder of the test, the furnace atmospheric pressure was controlled so that it complied with the requirements of BS 476: Part 20: 1987, Clause 3.2.2. The calculated pressure differential relative to the laboratory atmosphere at a position 100 mm below the underside of the assembly was 20 (+0, -2) Pa.

Test Observations

Time		All observations are from the unexposed face unless noted otherwise.
mins	secs	The ambient air temperature in the vicinity of the test construction was 19°C at the start of the test with a maximum variation of +2°C during the test.
00	00	The test commences.
12	34	Small amount of smoke issue from both ends of the floor.
15	43	Viewed from exposed face: Jointing tape detached from all joints in the plasterboard.
20	45	Viewed from exposed face: Bezels from downlighters I and D detached.
23	23	Temperature above downlighter A reaches 200°C.
26	17	Viewed from exposed face: Downlighter J detaches.
30	00	No significant visible change to unexposed face.
60	00	No significant visible change to unexposed face.
60	50	Viewed from exposed face: All joints in first layer of plasterboard widened to approximately 3mm.
62	45	Viewed from exposed face: Joint in first layer of plasterboard at approximately mid-length of the assembly widened to approximately 5mm.
70	07	Viewed from exposed face: Downlighter N detached from the assembly. Cavity temperature directly above 500°C. Hole through the plasterboard is evident.
72	39	Smoke release from both floor ends significantly increased in volume.
74	21	Viewed from exposed face: Joint in the first layer of plasterboard at approximately mid-length of the assembly widened to approximately 10mm.

Time

mins secs

78	17	Viewed from exposed face: Big chunk of first layer of plasterboard detached from approximately the centre of the assembly.
80	06	Viewed from exposed face: First layer of plasterboard adjacent to downlighter N position has sagged down by approximately 15mm.
81	54	Viewed from exposed face: Big chunk of first layer of plasterboard detached from approximately the centre of the assembly.
85	26	Viewed from exposed face: Approximately 50% of the first layer of the plasterboard is detaching from the ceiling.
86	40	Viewed from exposed face: Unable to see inside due to smoke within furnace chamber. Cavity temperatures in excess of 700°C.
90	00	Specimen is still satisfying loadbearing capacity, integrity and insulation criteria allowing test to continue.
93	00	Test discontinued.

Test Photographs

The unexposed face for the assembly after a test duration of 12 minutes



The unexposed face of the assembly after 30 minutes of testing



The unexposed face of the assembly after a test duration of approximately 60 minutes



The unexposed face of the assembly after 90 minutes of testing



Temperature & Deflection Data

Mean furnace temperature, together with the temperature/time relationship specified in the Standard

Time Mins	Specified Furnace Temperature Deg. C	Actual Furnace Temperature Deg. C
0	20	33
3	502	505
6	603	602
9	663	667
12	706	677
15	739	728
18	766	774
21	789	789
24	809	816
27	826	832
30	842	844
33	856	855
36	869	869
39	881	876
42	892	888
45	902	913
48	912	915
51	921	922
54	930	930
57	938	939
60	945	947
63	953	957
66	960	965
69	966	976
72	973	981
75	979	978
78	985	988
81	990	993
84	996	995
87	1001	989
90	1006	992
93	1011	997

Individual and mean temperatures recorded on the unexposed surface of the floor assembly

Time Mins	T/C Number 212 Deg. C	T/C Number 213 Deg. C	T/C Number 214 Deg. C	T/C Number 215 Deg. C	T/C Number 216 Deg. C	Mean Temp Deg. C
0	22	22	22	19	19	21
3	22	22	22	19	19	21
6	22	22	21	19	19	21
9	22	22	21	19	19	21
12	22	22	21	19	19	21
15	22	22	22	20	19	21
18	24	23	22	21	20	22
21	26	25	23	23	22	24
24	28	27	24	26	24	26
27	31	29	25	28	26	28
30	34	31	27	31	28	30
33	37	33	28	33	30	32
36	40	35	30	35	32	34
39	43	37	31	37	34	36
42	45	38	32	38	36	38
45	47	40	34	40	37	40
48	48	42	35	41	38	41
51	50	43	36	42	40	42
54	51	44	37	43	40	43
57	52	46	38	44	41	44
60	52	47	38	45	42	45
63	53	48	39	46	43	46
66	54	48	40	47	43	46
69	54	49	41	47	44	47
72	55	50	41	48	46	48
75	55	50	41	49	49	49
78	56	51	42	50	56	51
81	58	53	43	51	64	54
84	60	55	45	54	71	57
87	62	58	48	57	77	60
90	67	61	64	73	82	69
93	74	71	75	82	82	77

Individual temperatures recorded adjacent to joints in the flooring

Time Mins	T/C Number 217 Deg. C	T/C Number 218 Deg. C	T/C Number 219 Deg. C	T/C Number 220 Deg. C	T/C Number 221 Deg. C	T/C Number 222 Deg. C
0	20	20	19	20	20	19
3	20	20	19	20	20	19
6	19	20	19	20	20	19
9	19	20	19	20	20	19
12	19	20	19	20	21	19
15	20	20	19	20	22	20
18	21	20	20	20	23	21
21	22	21	21	21	25	23
24	24	23	23	22	28	25
27	26	24	25	24	31	27
30	29	26	28	25	34	30
33	32	26	30	27	36	30
36	34	28	32	28	39	35
39	37	31	34	30	42	39
42	39	34	35	31	44	42
45	41	35	37	33	46	44
48	43	37	38	34	48	46
51	45	39	39	35	50	47
54	46	40	40	37	51	49
57	48	42	41	38	52	50
60	49	44	42	39	53	51
63	50	45	42	40	54	52
66	51	46	43	41	54	53
69	51	48	44	42	55	55
72	52	50	44	43	56	58
75	53	53	45	44	58	62
78	53	58	46	47	60	66
81	54	66	48	51	63	71
84	56	74	51	61	67	77
87	58	78	55	74	72	80
90	61	80	64	80	76	83
93	79	81	79	83	78	88

Individual temperatures recorded adjacent to the light fittings at mid height of the cavity

Time	T/C	T/C	T/C	T/C	T/C	T/C	T/C	T/C
Mins	Number	Number	Number	Number	Number	Number	Number	Number
	223	224	225	226	227	228	229	230
	Deg. C	Deg. C	Deg. C	Deg. C	Deg. C	Deg. C	Deg. C	Deg. C
0	20	20	20	21	21	22	20	20
3	21	21	20	21	22	22	21	22
6	32	43	48	35	35	45	34	31
9	47	81	89	54	53	71	42	47
12	57	114	126	86	78	108	56	64
15	68	123	128	99	94	130	66	78
18	125	133	129	112	100	125	79	87
21	178	125	135	128	119	124	87	92
24	200	133	141	128	145	133	123	95
27	198	110	152	135	155	182	106	96
30	224	121	151	132	167	182	129	99
33	247	101	163	132	188	214	137	108
36	237	97	190	119	194	188	134	203
39	224	103	198	116	194	191	164	258
42	205	110	200	119	230	173	130	242
45	218	118	222	117	246	175	131	273
48	251	132	214	120	225	170	129	283
51	233	127	222	123	179	171	136	246
54	239	133	230	122	158	165	147	246
57	234	136	245	126	161	164	148	227
60	235	132	248	131	158	158	152	212
63	222	133	264	140	167	165	185	250
66	159	142	276	165	166	168	188	263
69	149	160	293	190	168	184	200	244
72	166	182	303	211	182	201	226	238
75	188	198	304	230	201	214	232	257
78	205	213	270	242	217	226	251	326
81	215	229	303	260	233	228	301	393
84	233	245	311	274	245	279	358	433
87	247	312	344	302	287	336	786	770
90	301	480	602	493	338	414	876	933
93	857	887	900	877	429	868	963	982

Individual temperatures recorded adjacent to the light fittings at mid height of the cavity

Time Mins	T/C Number 231 Deg. C	T/C Number 232 Deg. C	T/C Number 233 Deg. C	T/C Number 234 Deg. C	T/C Number 235 Deg. C	T/C Number 236 Deg. C	T/C Number 237 Deg. C	T/C Number 238 Deg. C
0	20	21	21	21	20	20	20	20
3	21	21	22	21	21	21	20	*
6	50	27	35	35	35	34	38	
9	62	40	45	67	54	52	54	
12	70	53	69	74	71	68	67	
15	92	65	132	73	79	66	88	
18	107	76	91	78	90	71	101	
21	127	83	115	82	90	77	104	
24	138	100	138	85	93	84	111	
27	151	91	95	88	99	88	109	
30	149	95	102	94	104	94	105	
33	150	102	122	99	110	102	107	
36	139	117	125	107	115	152	107	
39	134	159	135	134	122	166	113	
42	136	141	151	149	130	180	118	
45	134	165	165	155	137	167	121	
48	135	172	211	160	151	150	129	
51	143	155	256	163	149	163	134	
54	140	156	258	164	162	178	134	
57	142	148	251	160	172	175	135	
60	145	144	221	156	172	166	136	
63	156	146	263	155	189	155	141	
66	176	162	240	165	216	158	141	
69	197	165	524	187	234	186	158	
72	217	183	524	218	272	235	183	
75	233	200	569	250	289	277	229	
78	245	208	563	259	300	288	242	
81	259	219	540	264	332	297	239	
84	278	230	440	405	386	335	252	
87	702	673	449	840	872	799	745	
90	878	782	504	917	962	915	870	
93	940	825	823	913	979	944	886	

* Thermocouple malfunction

Deflection and rate of deflection of the floor assembly during the test

Time Mins	Central Vertical Deflection mm	Rate of Deflection mm/min
0	0.0	0.0
3	0.6	0.3
6	1.3	0.0
9	1.4	0.0
12	1.6	0.0
15	1.9	0.0
18	2.3	0.0
21	2.8	0.2
24	3.5	0.3
27	4.1	0.2
30	4.8	0.3
33	5.7	0.3
36	6.6	0.3
39	7.2	0.3
42	8.0	0.2
45	8.5	0.1
48	9.0	0.1
51	9.3	0.1
54	9.7	0.2
57	10.0	0.2
60	10.3	-0.1
63	10.6	0.2
66	10.8	0.0
69	11.1	0.2
72	11.6	0.2
75	12.4	0.3
78	13.7	0.5
81	15.0	0.5
84	17.4	0.7
87	21.7	2.2
90	32.7	4.4
93	50.3	6.7

Graph showing specified and actual furnace temperatures

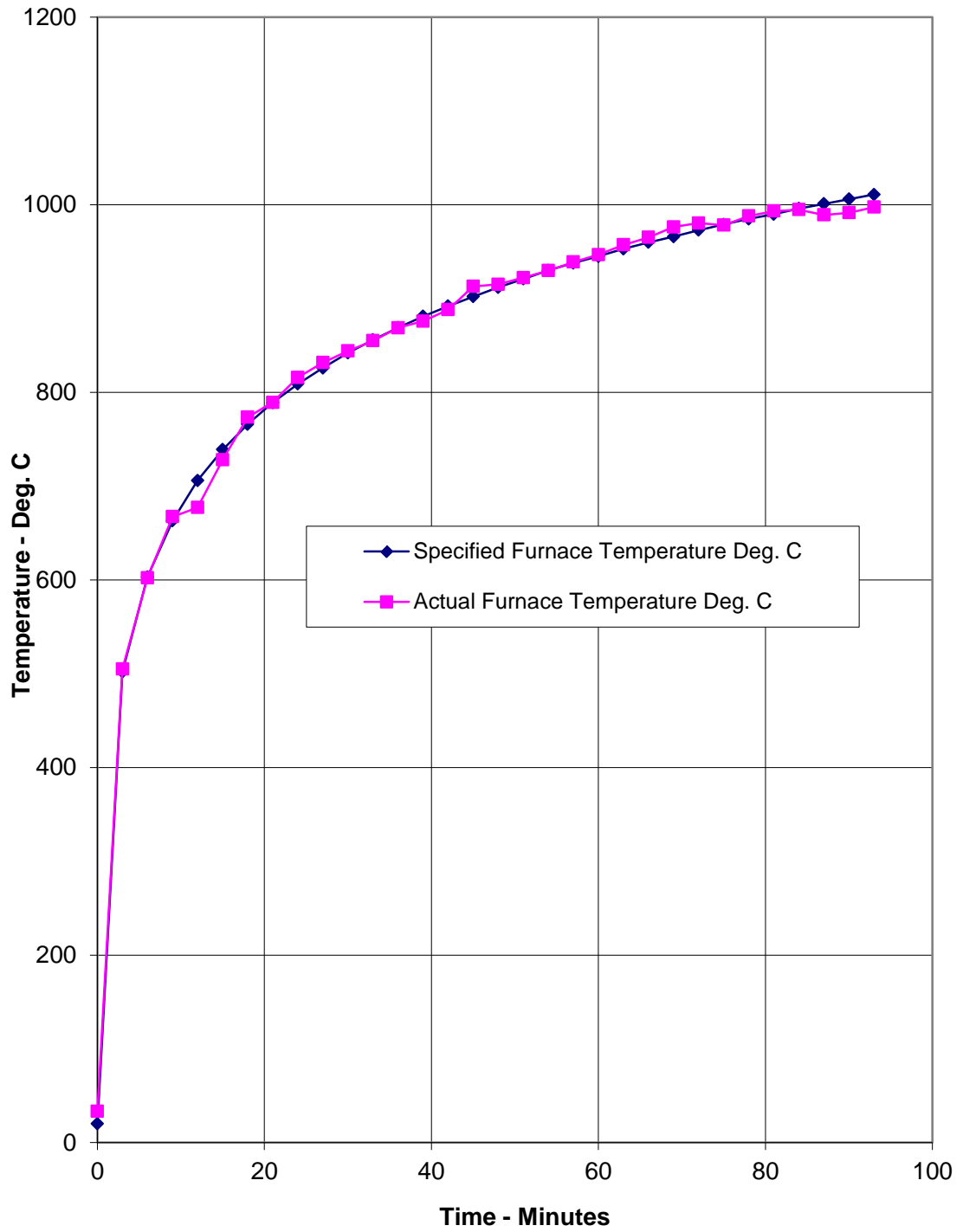

Graph showing mean unexposed surface temperature of the floor assembly

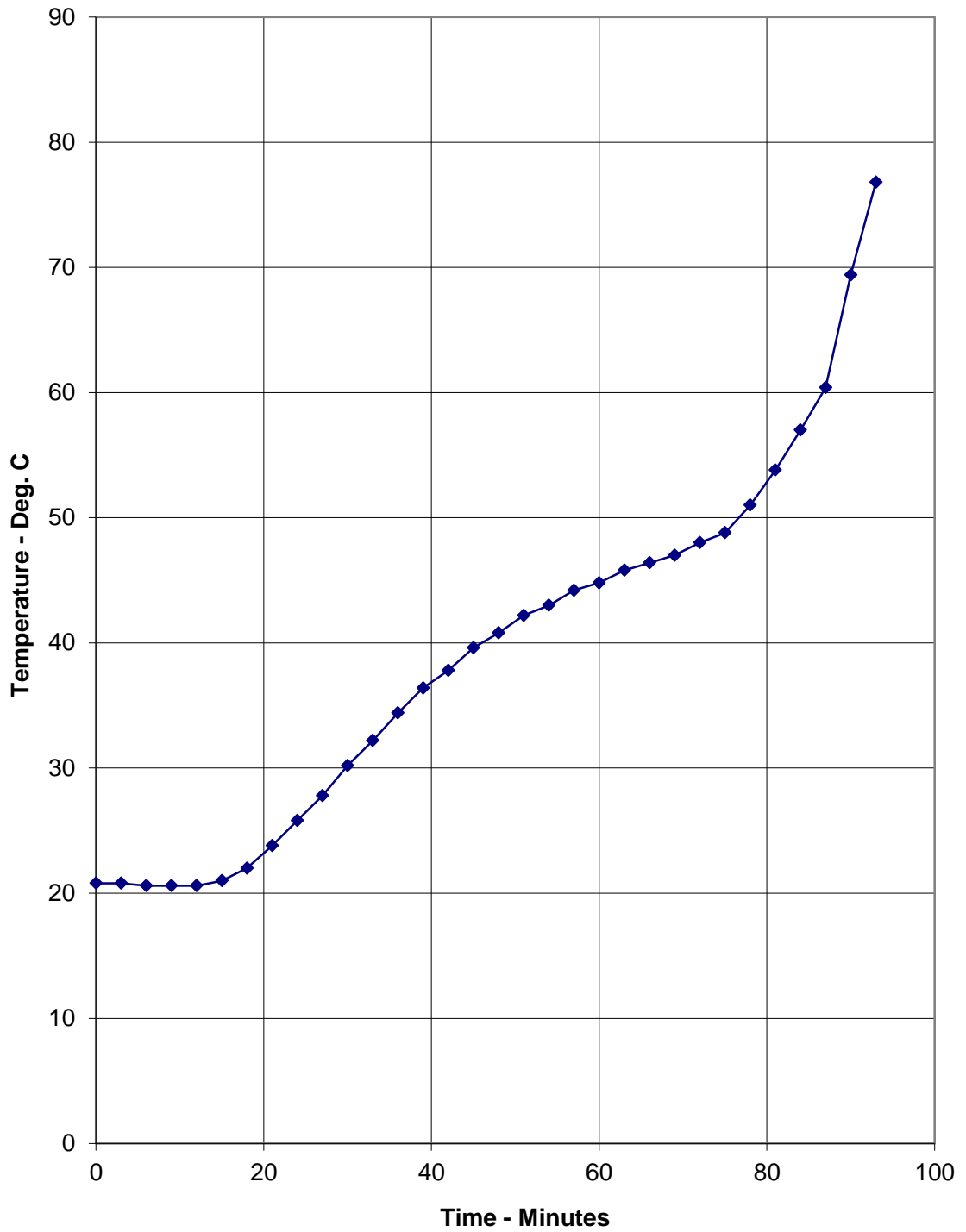

Graph showing the central vertical deflection of the floor assembly during the test

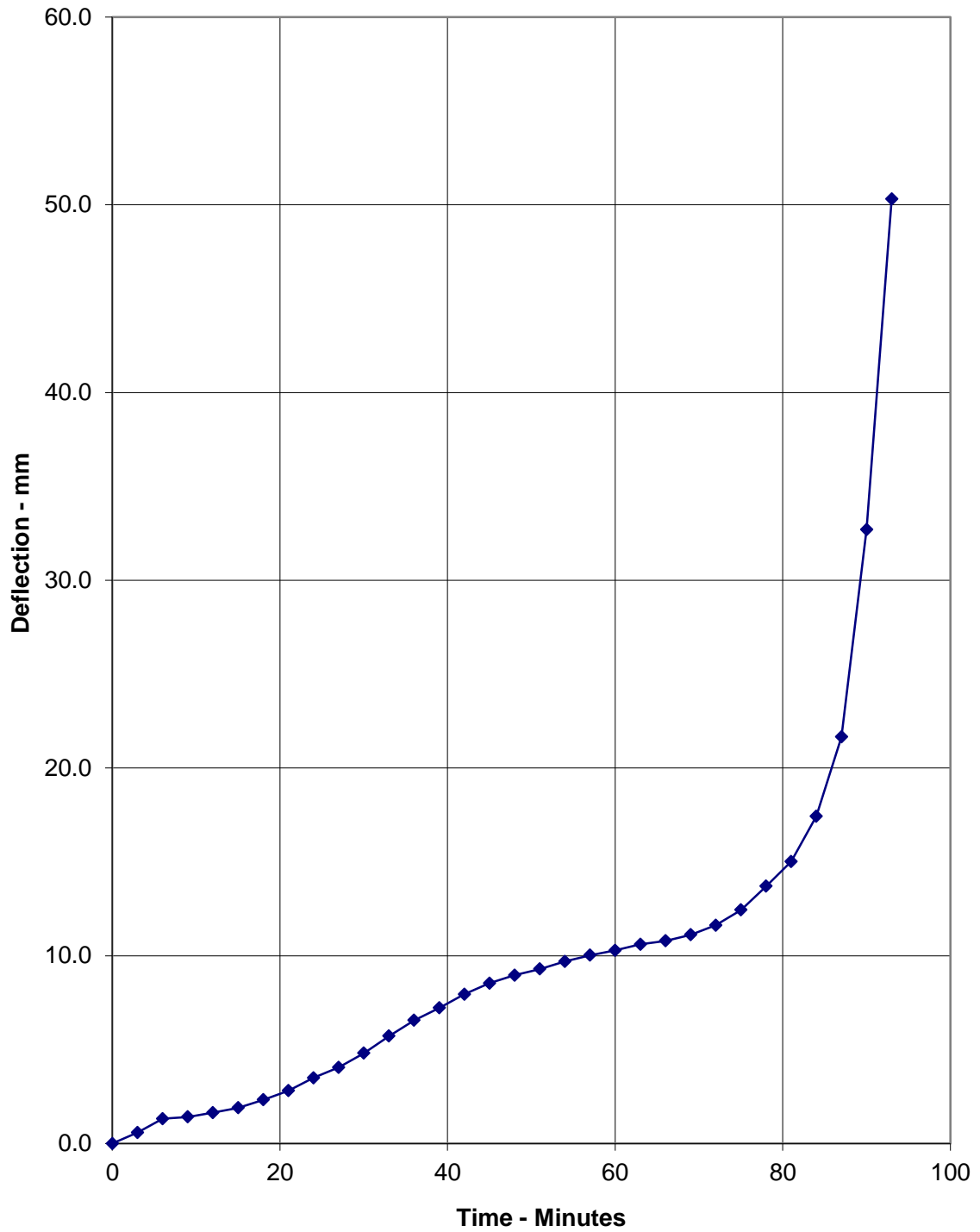

Load Calculations

1. Physical Parameters of Timber Joists

Measured Joist dimensions (d x b)	: 195 mm deep by 38 mm thick
Mean spacing (M)	: 450 mm
Effective span (L)	: 4400 mm
Timber grade of joists	: C16

2. Parameters - BS 5268: Part 2: 2002

Basic dry stress in bending	: 5.3 N/mm ² (Table 7)
Modification factor for loading	: 1.1 (Table 2.9 (a))
Therefore working stress (F)	: 5.83 N/mm ²
Nominal density	: 370 kg/m ³

3. Total Loading Required Per Joist

Moment of Inertia (I)	: $bd^3/12$: $(38 \times 195^3)/12$: 23480437.5 mm ⁴
Distance from neutral axis to base of joist (y)	: 97.5 mm
Maximum bending stress	: F/y : $(5.83 \times 23480437.5)/97.7$: 1404009.75 N/mm ²
Also maximum bending stress	: $wL^2/8$: 1404009.75 N/mm ²
Where w	= Load per unit length
∴ w	= $(1404009.75 \times 8) / (4400 \times 4400)$ = 0.580 N/mm = 580 N/m
∴ Total loading (W)	: 2552 N : 260.2 kg

4. Dead Weight

Combined weight of overall specimen:

Actual density of joist	: 360.2 kg/m ³
Actual density of floor boarding	: 652.2 kg/m ³
Actual density of ceiling board	: 911.7 kg/m ³

Effective width of floor supported per joist (m) : 0.45 m

weight of joist	: 11.7 kg
weight of floorboard	: 28.4 kg
weight of ceiling (two layers)	: 54.15 kg

Total dead weight per joist : 94.2 kg

5. **Imposed Load**

Imposed load per joist required : total load per joist - dead weight per joist
: 260.2 – 94.2
: 166 kg

Assuming even distribution of loading

Maximum imposed load per metre square : $(166 \times 9.81) / (4.4 \times 0.45)$
: 822.45 N/m²
: **0.822 kN/m²**
: 83.8 kg/m²

Calculation made by



W. Drazkiewicz
Technical Officer
Fire Resistance Department

Checked by

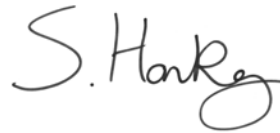

S. Hankey
Business Unit Head
For and on behalf of
Warringtonfire

Performance Criteria and Test Results

Loadbearing Capacity

The maximum allowable deflection and the maximum rate of deflection for the specimen, as specified by the Standard, are calculated as 200 mm and 9.11 mm per minute respectively. The allowable rate of deflection is not applicable until the deflection exceeds $\frac{1}{30}$ of the span (i.e. 140 mm). The test construction satisfied this requirement for the total test duration of 93 minutes.

Integrity

It is required that there is no collapse of the specimen floor assembly, no sustained flaming on the unexposed surface and no loss of impermeability. The test construction satisfied this requirement for the total test duration of 93 minutes.

Insulation

It is required that the mean temperature rise of the unexposed surface shall not be greater than 140°C and that the maximum temperature rise shall not be greater than 180°C. Insulation failure also occurs simultaneously with integrity failure. The test construction satisfied this requirement for the total test duration of 93 minutes.

Ongoing Implications

Limitations

The results relate only to the behaviour of the floor/ceiling assembly with downlighter specimens as an element of construction under the particular conditions of test. They are not intended to be the sole criteria for assessing the potential fire performance of the element in use, nor do they reflect the actual behaviour in fires.

The test results relate only to the specimen light fittings tested. Appendix A of BS 476: Part 20: 1987 provides guidance information on the application of fire resistance tests and the interpretation of test data. Application of the result to assemblies of different dimensions or supported in other manners or incorporating different components should be the subject of a design appraisal.

Review

The specification and interpretation of fire test methods are the subject of ongoing development and refinement. Changes in associated legislation may also occur. For these reasons it is recommended that the relevance of test reports over five years old should be considered by the user. The laboratory that issued the report will be able to offer, on behalf of the legal owner, a review of the procedures adopted for a particular test to ensure that they are consistent with current practices, and if required may endorse the test report.

Conclusions

Evaluation against objective A specimen of a loadbearing timber floor assembly, protected by a plasterboard ceiling incorporating sixteen down lighter fittings has been subjected to a fire resistance test in accordance with BS 476: Part 21: 1987, Clause 7.

The evaluation of the assembly against the requirements of BS 476: Part 21: 1987, Clause 7 showed that it satisfied the requirements the periods stated below:

Test Results:

Loadbearing Capacity 93 minutes*

Integrity 93 minutes*

Insulation 93 minutes*

*The test was discontinued after a period of 93 minutes.