



**ROLECEV**

**ZURA**

Intelligent EV charging unit



Manufactured  
in the UK

# ZURA

Intelligent EV charging unit

Versatile, sophisticated and packed with the most-wanted smart features, along with never-seen-before customisable aesthetics. ZURA has been designed for both homes and businesses, providing up to 22kW superfast charging.

This OCPP compliant unit offers plug & charge or pay-to-charge solutions via a mobile app or RFID operation through any OCPP back-office management system.

This EV charger supports dynamic load balancing and is equipped with PME fault detection, with no requirement for an earth rod, reducing installation costs.

Available with single or dual outlets, making it ideal for businesses and households with more than one EV, or that are looking to future-proof. Domestic users can also charge using their solar PV or other home renewables for a zero-cost, zero-carbon charge.\*

\*App dependent feature



**FREE app & support**

Domestic customers benefit from 3 years app connectivity and support included\*

\*Data fees may apply if connecting via 4G







# Product features

- Suitable for both domestic and commercial installations
- Plug & charge, mobile app or RFID controlled charging
- 1x or 2x universal charging socket(s) or Type 2 tethered lead(s)
- Up to 7.4kW or 22kW charging output(s)
- TruePEN PME fault detection (no earth rod required)
- Dynamic load balancing (CT clamp & cable included)
- Solar PV, battery storage or wind turbine integration\*
- Alexa & Google assistant compatible\*
- OCPP 1.6 compliant (can integrate with any back-office)
- Over-the-air firmware / software updates
- Built-in over current & 6mA DC leakage protection
- Cable lock security feature (can be permanently locked by user)
- Integrated RFID reader
- MID-approved energy metering
- 4G / Wi-Fi / Ethernet connectivity
- IK10 impact resistant design
- Independent back plate for easy wall or post mounting
- OZEV grant fundable
- Designed & manufactured in the UK

Rolec EV's chargepoint management platform:



Other preferred app & back-office partners:









\*App dependent feature



**OCPP 1.6 compliant**

Ability to integrate with any OCPP compliant back-office management system and app.



**Easy to operate**

Three quick and easy ways to operate: mobile app, RFID cards and fobs or plug & charge.



**Office for Zero Emission Vehicles**

**Eligible for grant funding**

This range is approved for the OZEV EV Chargepoint Grant & Workplace Charging Scheme (WCS).



**4G / Wi-Fi / Ethernet enabled**

Complete with secure 4G, Wi-Fi and Ethernet connectivity, ensuring chargers are always online 24/7.



**Branding & colour options available**

Rolec offer a bespoke chargepoint branding service; from logos & brand colours, to vinyl wraps.



**No earth rod required**

Equipped with built-in TruePEN PME fault detection, saving on installation time and costs.

## The details

### UP TO 22KW

Available in both single phase and three phase models, providing up to 22kW superfast charging.

Choose from single or dual outlet models, allowing two vehicles to charge simultaneously. Single outlet units can be upgraded to dual in the future.\*\*

### CHARGE FOR FREE!

Sync your solar PV, battery storage or wind turbine setup to benefit from sustainable, zero-cost, zero-carbon charging.

Smart home integration is also supported, so you can control your charger using Alexa or Google assistant.\*



### ACCURATE BILLING

Built-in MID-approved energy metering ensures accurate consumption reporting, which is essential for businesses and residential car parks, wishing to bill for their usage. Use our back-office management platform to generate revenue by setting your own tariffs.

### SAFE AND SECURE

Rest assured, Rolec's entire EV chargepoint range meets the currently required safety and security standards.

Over-the-air updates allow the chargers to receive the very latest features, ensuring a safe and future-proof product 24/7.

### 3 YEAR WARRANTY

Rolec EV chargepoints are designed, developed and manufactured in the UK and come with a 3 year warranty included as standard, for added peace of mind on your investment.

\*App dependent feature \*\*Single phase models only

# Specifications

## Product Overview:

	Connection Type	Charging Output	Input Supply	Fascia Colour	Product Code
Single Phase Units	1x Type 2 (IEC 62196) charging socket	Up to 7.4kW (32A)	1x 32A Single Phase 230V AC (±10 %) 50/60Hz	● Black	ROLEC3020B
	2x Type 2 (IEC 62196) charging sockets	Up to 7.4kW (32A) per socket	1x 63A Single Phase 230V AC (±10 %) 50/60Hz	● Black	ROLEC3030B
	1x Type 2 (IEC 62196) 5m tethered lead	Up to 7.4kW (32A)	1x 32A Single Phase 230V AC (±10 %) 50/60Hz	● Black	ROLEC3140B
	2x Type 2 (IEC 62196) 5m tethered leads	Up to 7.4kW (32A) per tethered lead	1x 63A Single Phase 230V AC (±10 %) 50/60Hz	● Black	ROLEC3150B
	1x Type 2 (IEC 62196) 10m tethered lead	Up to 7.4kW (32A)	1x 32A Single Phase 230V AC (±10 %) 50/60Hz	● Black	ROLEC3145B
	2x Type 2 (IEC 62196) 10m tethered leads	Up to 7.4kW (32A) per tethered lead	1x 63A Single Phase 230V AC (±10 %) 50/60Hz	● Black	ROLEC3155B
Three Phase Units	1x Type 2 (IEC 62196) charging socket	Up to 22kW (32A)	1x 32A Three Phase 400V AC (±10 %) 50/60Hz	● Black	ROLEC3046B
	1x Type 2 (IEC 62196) 5m tethered lead	Up to 22kW (32A)	1x 63A Three Phase 400V AC (±10 %) 50/60Hz	● Black	ROLEC3156B

Zura unit:

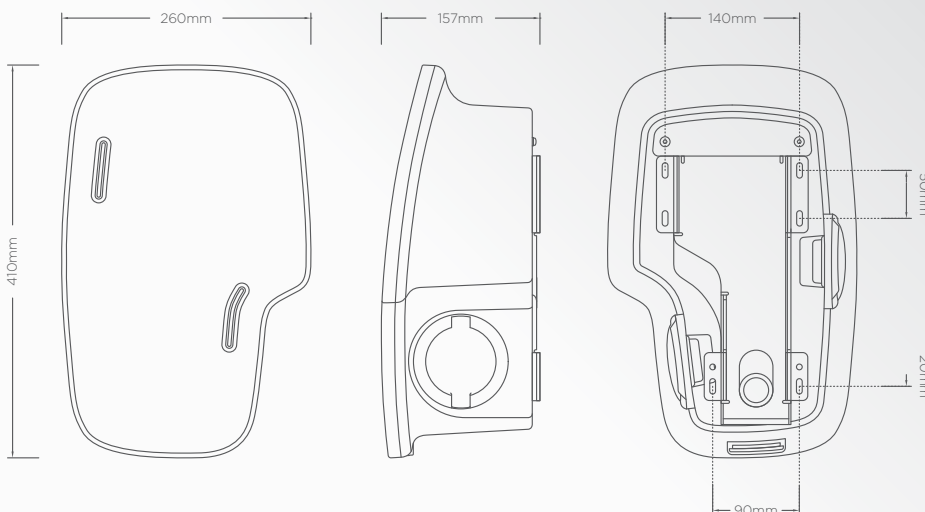



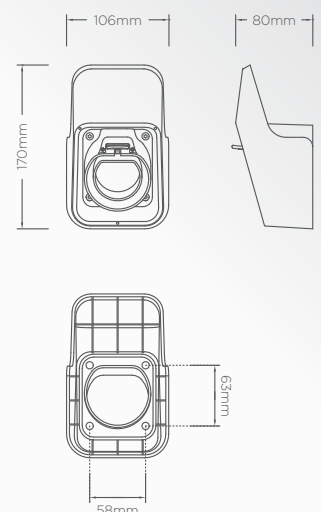

Type 2 charge gun holster:

Included with tethered units



# Specifications

## Technical Data:

<b>User Interface</b>	<ul style="list-style-type: none"> <li>• Mobile app</li> <li>• RFID reader (MIFARE ISO/IEC 14443 A)</li> <li>• Plug &amp; charge</li> <li>• RGB LED status indicator halo(s) – configurable</li> </ul>
<b>Charge Protocol</b>	Mode 3 (IEC 61851-1)
<b>Protection</b>	<ul style="list-style-type: none"> <li>• AC overload &amp; fault current protection – A dedicated 30mA Type A RCBO or equivalent protection is required at source (see page 7 for options)</li> <li>• Over current protection</li> <li>• DC fault protection – 6mA</li> <li>• Lightning surge, over temperature protection</li> <li>• TruePEN PME fault detection – No earth electrode/rod required</li> <li>• Supports automatic dynamic load balancing (may require additional hardware)</li> <li>• Supports static load management (software configurable)</li> </ul>
<b>Cable Terminals</b>	<ul style="list-style-type: none"> <li>• Single Phase – 3x 50mm 1P + N + E</li> <li>• Three Phase – 5x 50mm 3P + N + E</li> </ul>
<b>Communications</b>	<ul style="list-style-type: none"> <li>• 4G LTE Cat-1 (built-in nano SIM, subscription required)</li> <li>• Wi-Fi 802.11 b/g/n 2.4 GHz</li> <li>• RJ45 Ethernet connection</li> <li>• Bluetooth Low Energy (BLE 4.1) (for installer configuration purposes)</li> <li>• OCPP 1.6J</li> <li>• Cyber security – Data encryption level TLS 1.2</li> </ul>
<b>Energy Metering</b>	Integrated Class 1 MID compliant metering
<b>Standby Power Consumption</b>	< 7.5W (per socket)
<b>Dimensions</b>	260mm x 410mm x 157mm (W x H x D)
<b>Weight</b>	< 5.5kg (model dependant)
<b>Environmental</b>	<ul style="list-style-type: none"> <li>• Ingress protection – Enclosure IP65, Socket IP54</li> <li>• Impact protection – IK10</li> <li>• Security - Tamper protection boundaries</li> <li>• Operating temperature – -30°C to +50°C</li> <li>• Operating humidity – 5% to 95%</li> </ul>
<b>Materials</b>	<ul style="list-style-type: none"> <li>• Unit &amp; fascia - High impact resistant Polycarbonate</li> <li>• Mounting back plate - 1.5mm Steel with black powder coated finish</li> <li>• Rear bracket plate - 1.5mm 316 Stainless Steel</li> </ul>
<b>Unit Colour</b>	 Black
<b>Fascia Colour</b>	 Black  Grey  White  Branded or fully customised fascias available
<b>Certifications &amp; Compliances</b>	<ul style="list-style-type: none"> <li>• EV Charging Compliance – EN 61851-1:2019, EN 61851-22:2002</li> <li>• Smart Charge Points – (SI 2021/1467) Inc. Schedule 1</li> <li>• Wiring Regulations – BS 7671:2018+A2:2022</li> <li>• EMC Compliance – EN 61000-6-3:2007+A1:2011, EN 61000-6-2:2005, 2014/30 /EU, SI 2016/1091</li> <li>• Safety Compliance (LVD) – EN 62368-1:2014, 2014/35/EU, SI 2016/1101</li> <li>• Communications / RED – EN 62311:2008, 2014/53/EU, SI 2017/1206</li> <li>• Environmental Protection – BS EN 60529:1992+A2:2013</li> <li>• Impact Rating – BS EN 62262:2002+A1:2021</li> <li>• Metering – 2014/32/EU, SI 2016/1153</li> <li>• RoHS – 2011/65/EU, SI 2012/3032</li> <li>• REACH – 1907/2006, REACH etc. (Amendment) Regulations 2021</li> <li>• Certification Markings – CE &amp; UKCA</li> </ul>
<b>Warranty</b>	3 years



# Options & accessories

Product Code	Item Description
RFID0010	RFID card
RFID0020	RFID fob
EVFP0030	Zura Mounting Post   Fits up to 2 Chargers
EVCB0020	Root mount protection barrier - 48mm
EVCB0040	Surface mount protection barrier - 48mm
EVPS0010	EV parking sign - A4 landscape (Other sizes are available)
EVPP0100	5m 32A Type 2 to Type 2 charging cable
EVPP0107	10m 32A Type 2 to Type 2 charging cable
EVPP0105	5m 32A 3 Phase Type 2 to Type 2 charging cable
EVPP0108	10m 32A 3 Phase Type 2 to Type 2 charging cable (Other cables are available, including Type 1 options)
EVIN0010	20A Single Phase EV Consumer Unit with Type A RCBO
EVIN0015	40A Single Phase EV Consumer Unit with Type A RCBO
EVIN0070	20A Three Phase EV Consumer Unit with Type A RCBO
EVIN0075	40A Three Phase EV Consumer Unit with Type A RCBO
EVRS0030	Remote Wall Mount For Type 2 Charge Gun Holster
ACSR0125	100A up to 35mm <sup>2</sup> Screened CT Clamp with 10m Cable
ZURA0100B	Zura EV Charger Front Fascia Plate - Black
ZURA0100G	Zura EV Charger Front Fascia Plate - Grey
ZURA0100W	Zura EV Charger Front Fascia Plate - White



EVIN0010



ACSR0125



EVPS0010



RFID0020



EVPP0100



EVFP0030



## Personalise your own charger

For those interested in customisation or aesthetics, this is the perfect solution for you. Whether it's your company branding, favourite place, colour or an image of your pet, the choice is entirely yours. Contact Rolec for more details.

Brand names, logos and trademarks used herein remain the property of their respective owners. This listing of any firm or their logos is not intended to imply any endorsement or direct affiliation with Rolec Services Ltd. and is purely to demonstrate branding opportunities.

# BUSINESSES

WORKPLACE | COMMERCIAL | DEVELOPMENT | RESIDENTIAL | DESTINATION | FLEET



## VendElectric

- Full control of your own chargepoint network
- A future-proof and scalable solution
- Mapped network
- Customisable tariffs
- Generate revenue
- Smart reporting and analytical feedback
- Fleet management solutions
- Automatic fault notifications
- Over-the-air updates
- Optional electrical load management:

(Ideal for sites where the collective load may be greater than the electrical supply)



Other preferred back-office partners:

**MONTA**

**Fuuse**

**ChargePlace Scotland**  
electric vehicle charging

## Managing chargepoints

Rolec EV's range of AC fast and DC rapid chargepoints are suitable for all types businesses. OCPP integration allows these units to be managed by any compliant back-office, including Rolec EV's own management platform, VENDELECTRIC.

## Operating chargepoints

There are 3 quick and easy ways for drivers to operate the chargepoints: mobile app, RFID cards and fobs or plug & charge.

### VendElectric app

Manage your charging activity whilst benefiting from an variety of features:

- Easily find and navigate to a chosen destination using the chargepoint map
- Sort and save favourite locations
- View current & past charge sessions
- Review statistics and analytical data
- Exportable data (ideal for submitting benefit-in-kind claims)
- Live charge session notifications
- Virtual wallet for quick activation
- Multiple EVs can be added and used on a single registered account

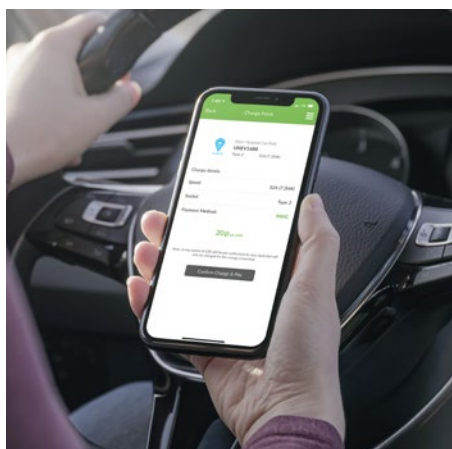

DOWNLOAD THE APP



### RFID card/fob

Ideal for workplace employees who frequently use the same charging points, whether for their own or their company vehicle. Hosts can assign an RFID to either the driver or a vehicle (VRM).



▶ For more about **VendElectric**, including data management pricing & plans, visit [www.rolecserv.com/chargepoint-management-system](http://www.rolecserv.com/chargepoint-management-system)



# HOMES

HOUSES | FLATS | RENTED ACCOMMODATION | PRIVATE GARAGES & PARKING SPACES



## Operating your chargepoint

Rolec EV's range of chargepoints for the home have been designed to provide an easy charging experience for EV drivers, allowing them to recharge their vehicle using their smartphone or handy RFID card/fob.

This range of chargepoints are OCPP compliant, enabling them to integrate with any compatible app the user desires.

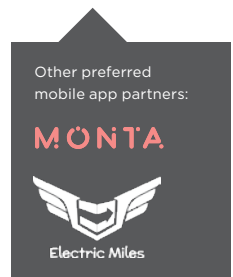

### ev.energy app

Smart charging using the greenest, cheapest energy couldn't be simpler!

- Mobile app controlled charging
- Set a charging completion time
- Automatic off-peak hours charging
- Smart schedule charging feature
- Compatible with all EVs & PHEVs
- Energy tariff driven charging
- Review statistics and analytical data
- Earn rewards for smart charging
- Lock Your Charger feature
- Live charge session notifications
- Immediate charge boost button
- Understand your charging costs
- Sync with your solar panel setup



DOWNLOAD THE APP



### RFID card/fob

Great for EV drivers who want to quickly activate their home chargepoint. RFID cards or key fobs are easily accessible and add for a much simpler charging experience, which can also be used alongside the mobile app.



▶ For more information about the ev.energy app, go to [ev.energy/solutions/app](https://www.ev.energy/solutions/app)

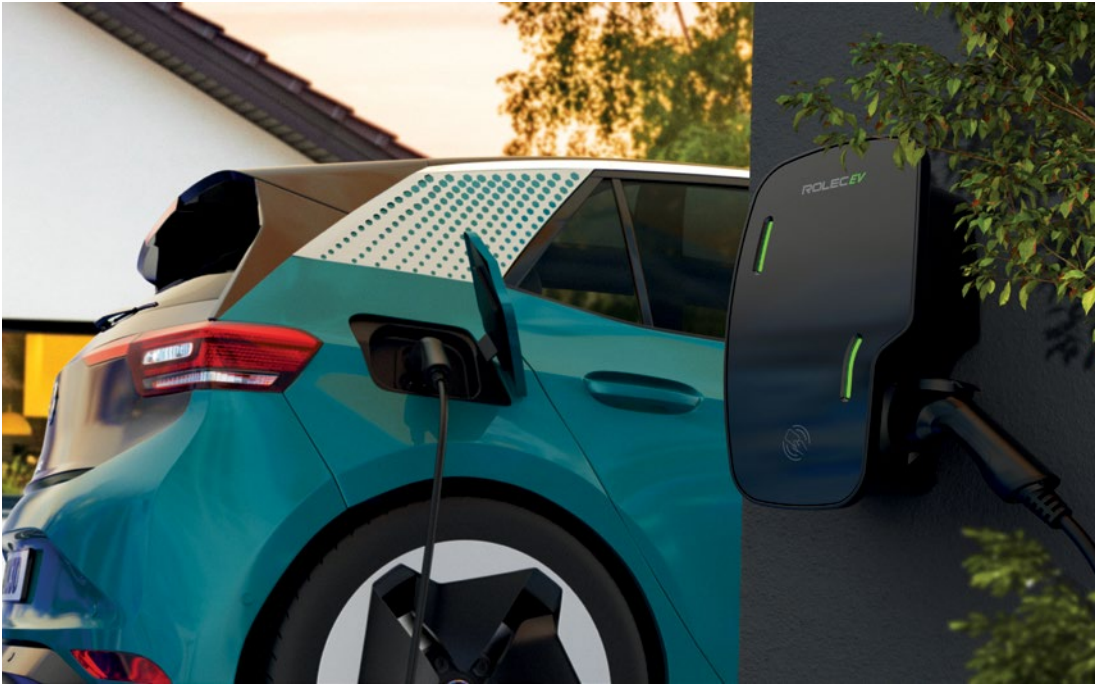

THIS DOCUMENT CONTAINS INFORMATION THAT IS SUBJECT TO CHANGE WITHOUT NOTICE.

The latest version of this publication can be downloaded at <https://www.rolecserv.com/downloads-ev-charging>

Illustrations of the product and user interface are for marketing purposes only.

Brand names, logos and trademarks used herein remain the property of their respective owners. This listing of any firm or their logos is not intended to imply any endorsement or direct affiliation with Rolec Services Ltd. and is purely to demonstrate branding opportunities.

© 2022 by Rolec Services. All rights reserved.

EVZD-V01-R2 Zura Data Sheet



Manufactured  
in the UK

---

**ROLECEV**

t: 01205 724754

e: [enquiries@rolecserv.co.uk](mailto:enquiries@rolecserv.co.uk)

[www.rolecserv.com](http://www.rolecserv.com)

