



Direct Electric and Indirect Cylinders

Up to 300L



EC-Eau Cylinder Range

Installation and User Instructions

Important - This manual must be left with the user after Installation!



Dimplex is a licensed member of the Benchmark Scheme which aims to improve the standards of installation and commissioning of domestic heating and hot water systems in the UK and to encourage regular servicing to optimise safety, efficiency and performance.

Benchmark places responsibilities on both manufacturers and installers. The purpose is to ensure that customers are provided with the correct equipment for their needs, that it is installed, commissioned and serviced in accordance with the manufacturer's instructions by competent persons and that it meets the requirements of the appropriate Building Regulations. The Benchmark Checklist can be used to demonstrate compliance with Building Regulations and should be provided to the customer for future reference.

Installers are required to carry out installation, commissioning and servicing work in accordance with the Benchmark Code of Practice which is available from the Heating and Hot Water Industry Council who manage and promote the Scheme. Visit www.centralheating.co.uk for more information.

The HWA Charter requires that all members adhere to the following:

- *supply fit for purpose products clearly and honestly described*
- *supply products that meet, or exceed appropriate standards and building and water regulations*
- *provide pre and post sales technical support*
- *provide clear and concise warranty details to customers*

For further information on the HWA Charter Membership, please refer to the HWA website www.hotwater.org.uk

0 Overall View

Reference	Description	Cylinder Included In This Range
01	Cold Water Inlet	ECSd100-580 100l Standard Direct Cylinder
02	Hot Water Outlet	ECSd125-80 125l Standard Direct Cylinder
03	T & P Valve	ECSd150-580 150l Standard Direct Cylinder
04	Bottom Immersion	ECSd210-580 210l Standard Direct Cylinder
05	Top Immersion	ECSd250-580 250l Standard Direct Cylinder
06	Technical Data Label	ECSd300-580 300l Standard Direct Cylinder

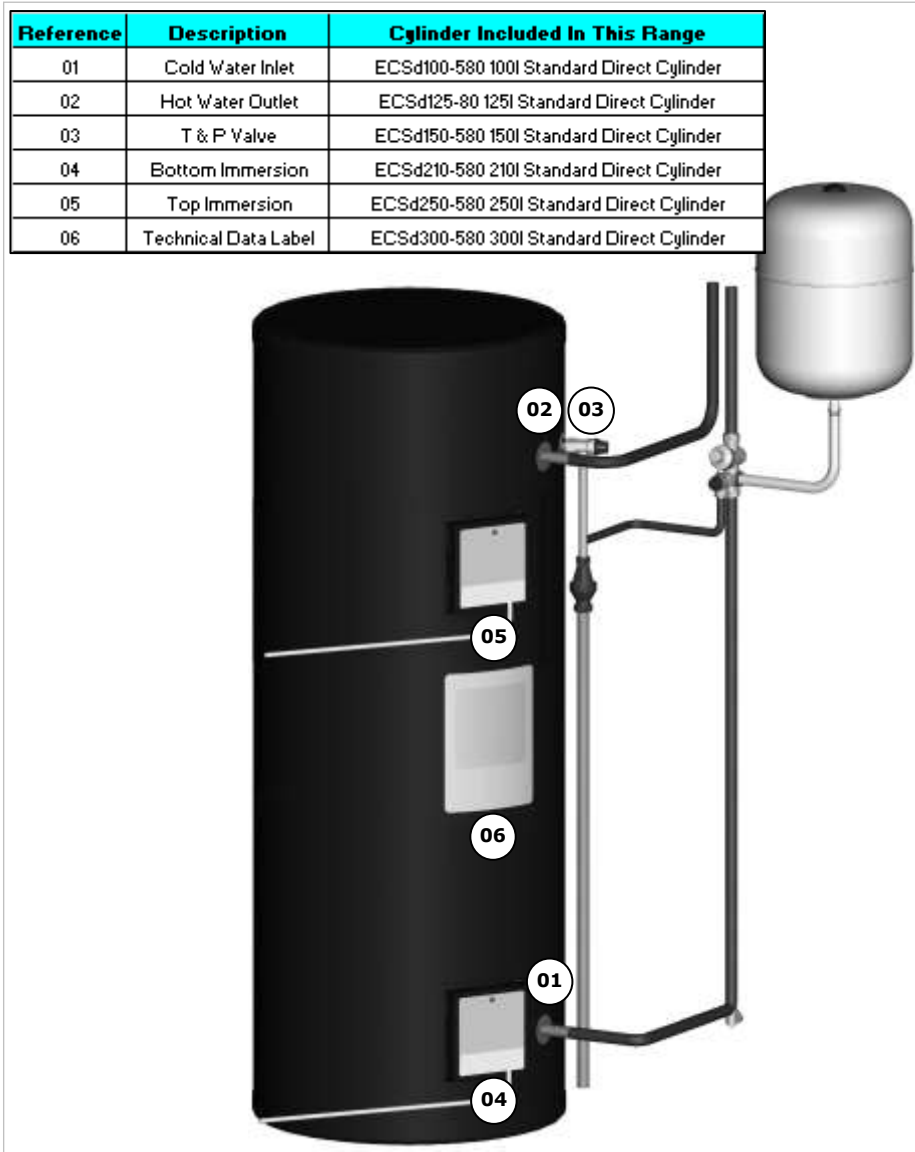

Figure 1: Overall view of **Direct Electric** Cylinder Installation Process

Reference	Description	Cylinder Included In This Range
01	Cold Water Inlet	ECSi100-580 100l Standard Indirect Cylinder
02	Hot Water Outlet	ECSi125-80 125l Standard Indirect Cylinder
03	T & P Valve	ECSi150-580 150l Standard Indirect Cylinder
04	Bottom Immersion	ECSi210-580 210l Standard Indirect Cylinder
05	Indirect Flow	ECSi250-580 250l Standard Indirect Cylinder
06	Indirect Return	ECSi300-580 300l Standard Indirect Cylinder
07	Bottom Thermostat	
08	Technical Data Label	

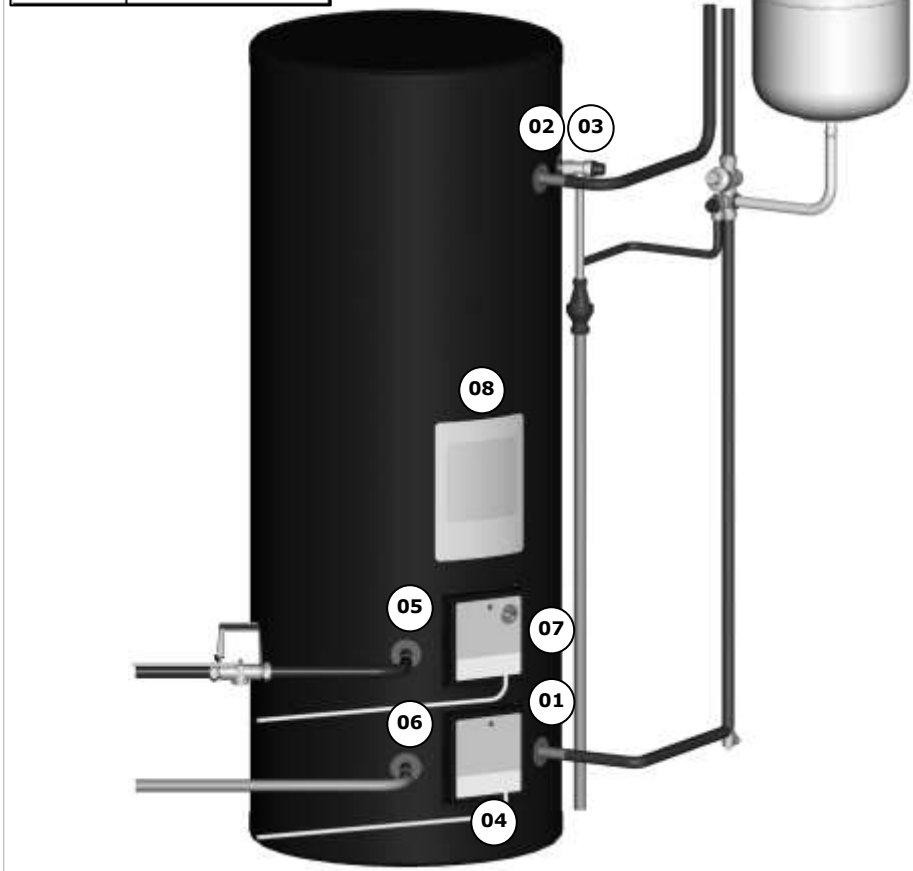

Figure 2: Overall view of **Indirect Cylinder** Installation Process

Overall View

1 Contents

0	Overall View	3
1	Contents	5
2	Introduction	7
3	Scope of delivery	7
4	Pre-Installation Advice	9
4.1	Risk assessment	9
4.2	Siting considerations	9
4.3	Cold water supply	10
4.4	Building regulation G3 Discharge requirements	11
4.4.1	Discharge pipe D2.....	12
4.4.2	Worked example.....	13
4.4.3	Termination of discharge pipe	14
4.5	Limitations	15
5	Installation	15
5.1	Cold Water Inlet with Inlet Control Group.....	15
5.1.1	Correctly site the cylinder	15
5.1.2	Install the inlet group	15
5.1.3	Expansion vessel	15
5.1.4	Balanced cold water supply	16
5.1.5	Drain valve	16
5.2	Hot Water Outlet.....	16
5.2.1	Thermostatic mixing valve	16
5.2.2	Pipe insulation.....	16
5.3	Discharge pipes from safety devices.....	16
5.3.1	Discharge pipe D1.....	16
5.3.2	Discharge pipe D2.....	17
5.3.3	Tundish	17
5.4	Immersion heater	18
5.5	Coil flow connections (indirect models only)	18
5.6	Coil return connections (indirect models only)	18
5.7	Thermostat connection (indirect models only).....	19
5.8	Connection of Secondary Return	22
6	Commissioning	23
7	Maintenance	24
8	Spare Parts	26
9	Technical Data and Product Fiche	27
9.1	Cylinder heat exchanger pressure drop	33

10	User Instructions.....	34
10.1	General	34
10.2	Operation	35
10.2.1	Water temperature direct electric heating	35
10.2.2	Water temperature auxiliary heating	36
10.3	Maintenance.....	36
10.4	Troubleshooting.....	37

2 Introduction

Thank you for choosing a Dimplex product. The EC-Eau direct electric and indirect cylinders are specified with high quality, long-life immersion heaters and large surface area coils for fast reheat times. They boast 60mm of low GWP insulation foam, together with 100% recyclable stainless steel inner components and a sleek black, hard wearing outer shell manufactured from completely recycled materials. For more detailed information on product features, please see the Technical Data section in this manual.

NOTE: This product has been designed specifically for the purpose of delivering heated, domestic and sanitary hot water as part of a pressurised water heating system. The package is provided with fittings that comply with Section G3 of Building Regulations.

WARNING: Dimplex cannot take responsibility for ensuring safe operation of the appliance outside of the scope of intended use.

3 Scope of delivery

Please ensure you check the scope of delivery below before signing any delivery documentation. Claims for missing or damaged parts after signing for the delivery will not be accepted.













Scope of delivery							
Cylinder volume		100l	125l	150l	210l	250l	300l
Cylinder with 3kW immersion *		1	2	2	2	2	2
T+P valve *		1/2", 7bar/90°C			1/2", 7bar/90°C	1/2", 7bar/90°C	
Inlet control group consisting of:-							
- in line strainer							
- 3 bar PRV							
- 6 bar ERV			✓		✓	✓	
- non-return valve							
- balanced cold water supply port							
- connection for expansion vessel							
Expansion vessel with fixing kit and connection hose		12 l			18 l	24 l	
Tundish		15mm/22mm			15mm/22mm	15mm/22mm	
Installation & User Instructions x 1		✓			✓	✓	
Terms and conditions x 1		✓			✓	✓	

Table 2: Scope of Delivery *Direct* Cylinders

Scope of delivery							
Cylinder volume		100l	125l	150l	210l	250l	300l
Cylinder with 3kW immersion *		1	1	1	1	1	1
T+P valve *		1/2", 7bar/90°C			1/2", 7bar/90°C		1/2", 7bar/90°C
Inlet control group consisting of:-							
- in line strainer							
- 3 bar PRV							
- 6 bar ERV							✓
- non-return valve							✓
- balanced cold water supply port							✓
- connection for expansion vessel						✓	
22mm motorised two port valve							✓
Expansion vessel with fixing kit and connection hose		12 l			18 l		24 l
Tundish		15mm/22mm			15mm/22mm		15mm/22mm
Installation & User Instructions x 1							✓
Terms and conditions x 1							✓

* These items are supplied factory fitted

Table 3: Scope of Delivery for **Indirect** Cylinders

4 Pre-Installation Advice

Please read the following section carefully before commencing installation. If in any doubt, please call the appropriate help desk. Disregarding the instructions given in this manual in its entirety and any relevant regulations, standards and codes of practice will void the guarantee of this product.

Handling – depending on the size of the unit and access to its installation location, consideration must be given to the handling of the unit. Please note that handling, installation and use of this product is subject to the Health and Safety at Work Act.

If the unit is not installed immediately, it should remain in its protective packaging with all pipe protectors/end caps applied to prevent damage and dirt deposit inside the cylinder and the coils.

Pipe work – the pipe runs should be executed as short as possible, unused pipe work should be removed and all remaining pipe work should be lagged in accordance with regulatory requirements to prevent heat loss and the formation of condensation.

Taps and fittings – all taps and fittings incorporated in the unvented system should have a rated operating pressure of 0.6 MPa (6 bar) or above.

4.1 Risk assessment

The compilation of a risk assessment is strongly recommended before installing the product. The following areas require particular consideration in addition to the information required by the Health and Safety at Work Act.

- scalding: where appropriate or required by law a thermostatic mixing valve is to be fitted to the hot water outlet of the cylinder (see also water borne organisms).
- explosion: the unit is fully equipped with all relevant safety equipment to comply with current regulations. The correct design and function has been verified by independent third party testing. The correct application thereof is the responsibility of the competent installer.
- water borne organisms (i.e. Legionella): if applicable a risk assessment should be carried out following the recommendations outlined in the Approved Code of Practice L8.
- the user preference must be considered when commissioning the system, in particular when adjusting the solar and auxiliary system temperature and timer settings.

4.2 Siting considerations

When choosing a suitable location for the cylinder the following aspects should be considered:

- structural integrity
- access for installation, operation, maintenance and replacement
- routing of discharge pipe work
- access to water mains supply, hot and cold water distribution pipe work
- access to suitable electricity supply
- location in relation to remaining system components such as auxiliary and solar heating system

- frost protection

The direct electric and indirect cylinder ranges are designed to be floor standing, vertically mounted, indoors and in a frost free environment. The cylinder may be located on any flat and level surface, provided it is sufficiently robust to support the weight of the cylinder when full of water (please see technical data) and suitably accessible for replacement/maintenance without specialist tools or lifting equipment as this will void the warranty conditions.

The position and orientation of the cylinder should be such that easy access is provided for servicing the controls. A minimum distance of 400mm in front of the immersion is recommended, to allow the replacement of the immersion heater should the need arise. When installing the cylinder all labels should be clearly visible and ensure that no pipework hinders any work to be carried out on the various cylinder components.

Particular care must be taken when placing the cylinder in a garage or outbuilding. All exposed pipe work must be correctly insulated to avoid frost damage.

CLEANING INSTRUCTIONS:

Clean outer cladding of cylinder with a soft cloth dampened with warm water only. Do not use abrasive or aggressive cleaning materials, such as alcohol or petroleum based solvents, as this may damage the surface of the product.



4.3 Cold water supply

For satisfactory and safe performance of the unvented cylinder the water supply must meet the following criteria:

Minimum dynamic pressure	150 kPa (1.5 bar)
Maximum inlet supply pressure	1200 kPa (12 bar)
Minimum flow rate	15 l/min
Max. chlorine content	250mg/L
Max. water hardness	200mg/L

The following instructions have to be followed when installing the cold water mains supply to the cylinder:

- The cold water supply to the cylinder must come directly from the cold water mains after the mains stop valve to the property.
- The cold water inlet pipe work should have at least an inside diameter of 19mm and should meet the requirements of the water regulations for the supply of wholesome water.

Dimplex recommend an annual maintenance inspection is carried out on the domestic hot water cylinder. In hard water areas this should include inspection of the heat exchanger and immersion heater, [above 120ppm or 120mg/l]. A local water treatment company should be able to offer free water quality testing. The heating elements may require periodic de-scaling. The installer should do this as part of a maintenance agreement.

If required, precautions can be taken to minimise effects of water hardness, i.e. installation of water conditioner or water softener. These devices should be installed in hard water areas where high water storage temperatures are required, i.e. greater than 60°C storage temperatures, particularly when water hardness exceeds 200ppm. Should the water cylinder require de-scaling, this must be performed by a qualified technician.

4.4 Building regulation G3 Discharge requirements

As part of the requirements of Building Regulation G3 any discharge from an unvented system should be conveyed to where it is visible, but will not cause danger to persons in or about the building. The tundish and the discharge pipes should be fitted in accordance with the requirements of Building Regulation approved document G3, (England and Wales), Part P of Northern Ireland and Standard 4.9 of Scotland.

4.4.1 Discharge pipe D2

The discharge pipe (D2) from the Tundish should:

- "have a vertical section of pipe at least 300mm long below the tundish before any elbows or bends in the pipework and be installed with a continuous fall of at least 1 in 200 thereafter."

The discharge pipe (D2) should be made of:

- "metal; or other material that has been demonstrated to be capable of safely withstanding temperatures of the water discharged and is clearly and permanently marked to identify the product and performance standard"

Dimplex strongly recommends the use of metal pipework only and Dimplex does not take responsibility for any damage caused from discharges.

The discharge pipe D2 should be at least one pipe size larger than the nominal outlet size of the safety device unless its total equivalent hydraulic resistance exceeds that of a straight pipe 9m long, i.e. for discharge pipes between 9m and 18m the equivalent resistance length should be at least two sizes larger than the nominal outlet size of the safety device; between 18 and 27m at least 3 sizes larger, and so on; bends must be taken into account in calculating the flow resistance. See Figure 3, Table 4 and the worked example.

Note: An alternative approach for sizing discharge pipes would be to follow Annex D, section D.2 of BS 6700:2006 + A1:2009).

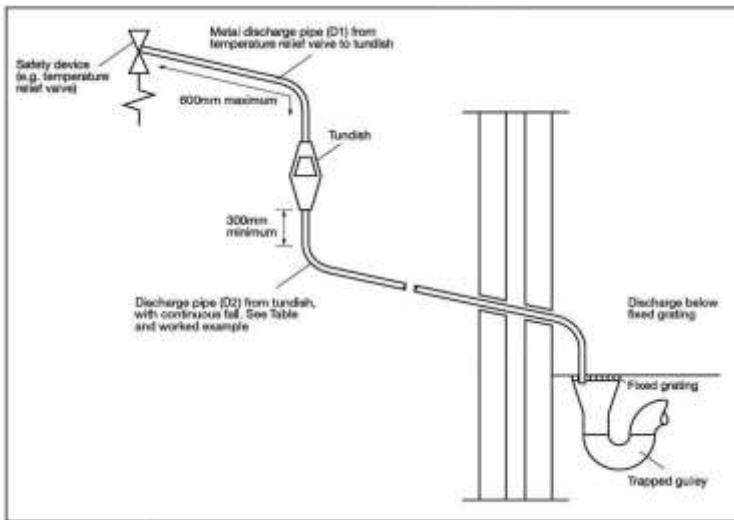

Figure 3: Typical discharge pipe arrangement

Valve outlet size	Minimum size of discharge pipe before tundish	Minimum size of discharge pipe after tundish	Maximum allowed length of pipe after tundish	Length to be subtracted for each elbow or bend
	[mm]	[mm]	[m]	[m]
G1/2	15	22	9	0.8
		28	18	1.0
		35	27	1.4
G3/4	22	28	9	1.0
		35	18	1.4
		42	27	1.7
G1	28	35	9	1.4
		42	18	1.7
		54	27	2.3

Table 4: Sizing of copper discharge pipe "D2" for common temperature relief valve outlet sizes

4.4.2 Worked example

This example is for a G½ temperature relief valve with a discharge pipe (D2) (as fitted on 125 to 300L cylinders) having 4 No. 22mm elbows and length of 7m from the tundish to the point of discharge.

From Table 4, the maximum resistance allowed for a straight length of 22mm copper discharge pipe

(D2) from a G½ temperature relief valve is 9.0m. Subtract the resistance for 4 No. 22mm elbows at 0.8m each = 3.2m.

Therefore the maximum permitted length

equates to 5.8m, which is less than the actual length of 7m, therefore calculate the next largest size.

Maximum resistance allowed for a straight length of 28mm copper discharge pipe (D2) from a G½ temperature relief valve is: 18m

Subtract the resistance for 4 No. 28mm elbows at 1.0m each = 4m

Therefore the maximum permitted length equates to 14m.

As the actual length is 7m, a 28mm (D2) copper pipe will be satisfactory.

- Where a single common discharge pipe serves more than one system, it should be at least one pipe size larger than the largest individual discharge pipe (D2) to be connected.
- The discharge pipe should not be connected to a soil discharge stack unless the soil discharge stack is capable of safely withstanding temperatures of the water discharged, in which case, it should:
 - contain a mechanical seal, which allows water into the branch pipe without allowing foul air from the drain to be ventilated through the tundish.
 - there should be a separate branch pipe with no sanitary appliances connected to it.
 - if plastic pipes are used as branch pipes carrying discharge from a safety device, they should be either polybutylene (PB) or cross-linked polyethylene (PE-X) complying with national standards.
- be continuously marked with a warning that no sanitary appliances should be connected to the pipe.

4.4.3 Termination of discharge pipe

- *"The discharge pipe (D2) from the tundish should terminate in a safe place where there is no risk to persons in the vicinity of the discharge."*
- Examples of acceptable discharge arrangements are:
 - "to a trapped gully with the end of the pipe below a fixed grating and above the water seal;
 - downward discharges at low level; i.e. up to 100mm above external surfaces such as car parks, hard standings, grassed areas etc. are acceptable providing that a wire cage or similar guard is positioned to prevent contact, whilst maintaining visibility; and ,
 - discharges at high level: e.g. into a metal hopper and metal downpipe with the end of the discharge pipe clearly visible or onto a roof capable of withstanding high temperature discharges of water and 3m from any plastic guttering system that would collect such discharges."

Note: As the discharge would consist of high temperature water and steam, asphalt, roofing felt and non-metallic rainwater goods may be damaged by such discharges.

4.5 Limitations

Due to the operating temperatures of direct electric water heaters the water hardness can considerably influence the longevity of the immersion heater element. Please consult local water board for advice on maintenance intervals.

5 Installation

5.1 Cold Water Inlet with Inlet Control Group

5.1.1 Correctly site the cylinder

Install the cylinder in an appropriate location, ensuring all of the recommendations have been considered (see chapter 4.2).

5.1.2 Install the inlet group

The inlet group regulates the pressure of the incoming mains water supply to the cylinder and removes any debris that might be water borne.

Note: Between the inlet group and the cold water inlet on the cylinder NO isolating device may be fitted, as by doing so important safety devices could be isolated!

5.1.3 Expansion vessel

The expansion vessel is mandatory on all EC-Eau cylinders and can be connected directly to the cold water inlet group, utilising the flexible hose supplied with the vessel. The expansion vessel should always be fitted in accordance with the manufacturer's instructions. No isolating device must be fitted between

the water cylinder and the cold water inlet group.

Furthermore, it is recommended to mount the vessel higher than the cylinder to avoid having to drain the cylinder when maintaining and replacing the expansion vessel.



Figure 4: Connection of the expansion vessel to the inlet group



It is important to check the pre-charge pressure of the expansion vessel membrane before filling the cylinder. The pre-charge should be greater than or equal to 3 bar.

Note: The expansion vessel must be installed to the side of the expansion relief valve on the inlet group. To do this the blanking plug must be removed and the expansion vessel connected, as shown in Figure 5.

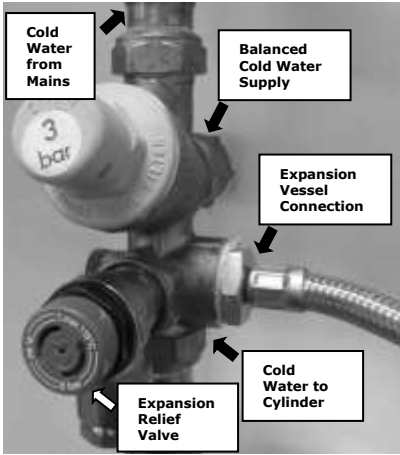

Figure 5: Detail showing the connection of the expansion vessel to the inlet group

5.1.4 **Balanced cold water supply**

If a balanced cold water supply is required a connection can be taken from the bottom of the inlet group.

5.1.5 **Drain valve**

It is also recommended to install a drain valve (not supplied) in the lowest point of the cold water feed to the cylinder. This allows the cylinder to be drained in a controlled manner should this become necessary.

5.2 **Hot Water Outlet**

The hot water pipe work is to be directly connected to the hot water outlet connection on the cylinder, see Figure 1.

5.2.1 **Thermostatic mixing valve**

A thermostatic mixing valve may be required to limit the outlet temperature. In this case, the valve should be installed following the manufacturer's instructions, ensuring none of the safety equipment has been isolated, (i.e. make sure the connection to the thermostatic mixing valve is taken after the safety equipment of the inlet group).

5.2.2 **Pipe insulation**

It is recommended to insulate the hot water pipe work from the cylinder to the outlets, to reduce the energy requirements for providing hot water. It is also recommended to insulate all other exposed pipework, such as the T&P to the tundish, the coil flow and return and the cold water inlet pipes.

5.3 **Discharge pipes from safety devices**

5.3.1 **Discharge pipe D1**

- The temperature and pressure relief valve must be discharged directly or by way of a manifold via a short length of metal pipe (D1) into a tundish; and the discharge pipe must be installed in a continuously downward direction and in a frost free environment. Water may drip from the discharge pipe of the pressure relief device and this pipe must be left open to the atmosphere.
- The diameter of discharge pipe (D1) should not be less than the nominal outlet size of the safety device, e.g. temperature relief valve.
- Where a manifold is used it should be sized to accept and discharge the

total discharge from all the D1 discharge pipes connected to it.

- The discharge pipe work from the expansion relief valve must be installed constantly falling to an open point of discharge. It is recommended to combine it with the discharge of the temperature and pressure relief valve.

Note: The T&P valve is pre-sealed and if moved the seal will be broken, should this occur, it will need to be resealed with an appropriate sealant (Dimplex part number R00836-1).

5.3.2 Discharge pipe D2

For a detailed description of the discharge pipework D2 see chapter 4.4.1.

5.3.3 Tundish

- The tundish should be vertical, located in the same space as the unvented hot water storage system and be fitted as close as possible to, and lower than, the safety device, with no more than 600mm of pipe between the valve outlet and the tundish (see Figure 3).
- Discharge should be visible at the tundish, where discharges may not be apparent, e.g. in dwellings occupied by people with impaired vision or mobility, consideration should be given to the installation of a suitable safety device to warn when discharge takes place, e.g. electronically operated.

Note: To comply with the Water Supply (Water Fittings) Regulations, the tundish should incorporate a suitable air gap.



It is important that the tundish is positioned away from any electrical components.

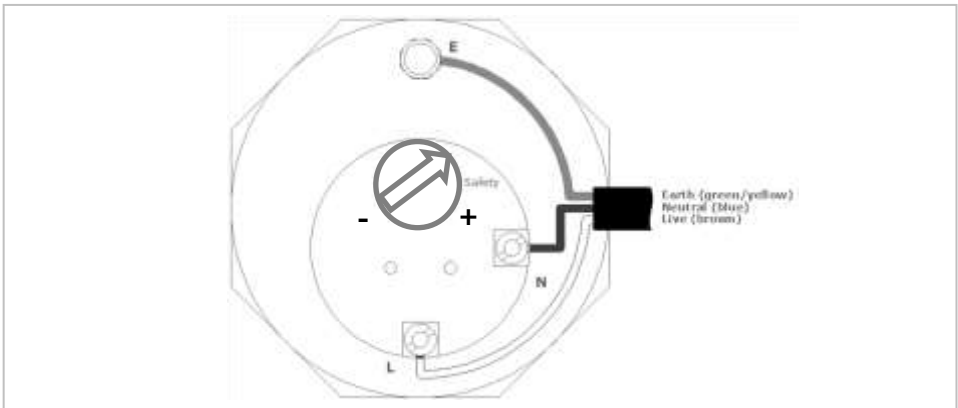

Figure 6: Wiring diagram for Immersion Heater

5.4 Immersion heater

The immersion heater has to be connected in accordance with IEE Wiring Regulations and the installer carrying out the work has to be suitably qualified. It must be connected through a double pole isolating switch or suitable controller which must have a contact separation of at least 3mm in all poles. The wiring diagram can be seen in Figure 6. For further details please see instructions provided with the immersion heater.

The immersion heater incorporates an independent non-self resetting over temperature cut-out. Should the over temperature cut-out operate, the reset pin will be pushed upwards, and become level or slightly proud of the cover at the position marked "Safety". Use a suitable sized implement to reset the pin by pushing it hard into its original position.

Note: Should it be necessary to remove the thermostat from the immersion element, ensure that the contacts are re-fitted correctly into the positions on the element. Failure to do so carries the risk of overheating the contacts and thus damaging the appliance.

The immersion heater thermostat must not be opened under any circumstances.

Note: The cylinder must be filled with water before switching on the immersion heater. Failure to do so will damage the element and void any guarantee on the product.

5.5 Coil flow connections (indirect models only)

If the flow connection is the highest point in the indirect heating loop and if the system was not commissioned using a flush and fill pump, an adequate device for de-aeration must be installed.

5.6 Coil return connections (indirect models only)

If the return connection is the lowest point in the indirect heating loop, a suitable drain device should be installed. For location of connections see Figure 2.

It is recommended that the fittings used to connect to the cylinder are suitable for stainless steel, the flow and return should use 22mm compression fittings. Not all push fit fittings can be used – please check with your supplier. When using compression fittings, ensure that the connection is not over-tightened.

5.7 Thermostat connection (indirect models only)

The indirect heating source can be connected to the cylinder in various ways as described by the system supplier. The wiring and installation principles for two typical integration methods are detailed in Figure 8 and Figure 9.

To conform to building regulations, it is imperative that any heat generator connected to the cylinder is installed through the correct twin thermostat, which is factory fitted to the cylinder. The two port valve supplied with the indirect cylinder is to be installed by default into the heating loop. For access to the thermostat wiring see Figure 7.

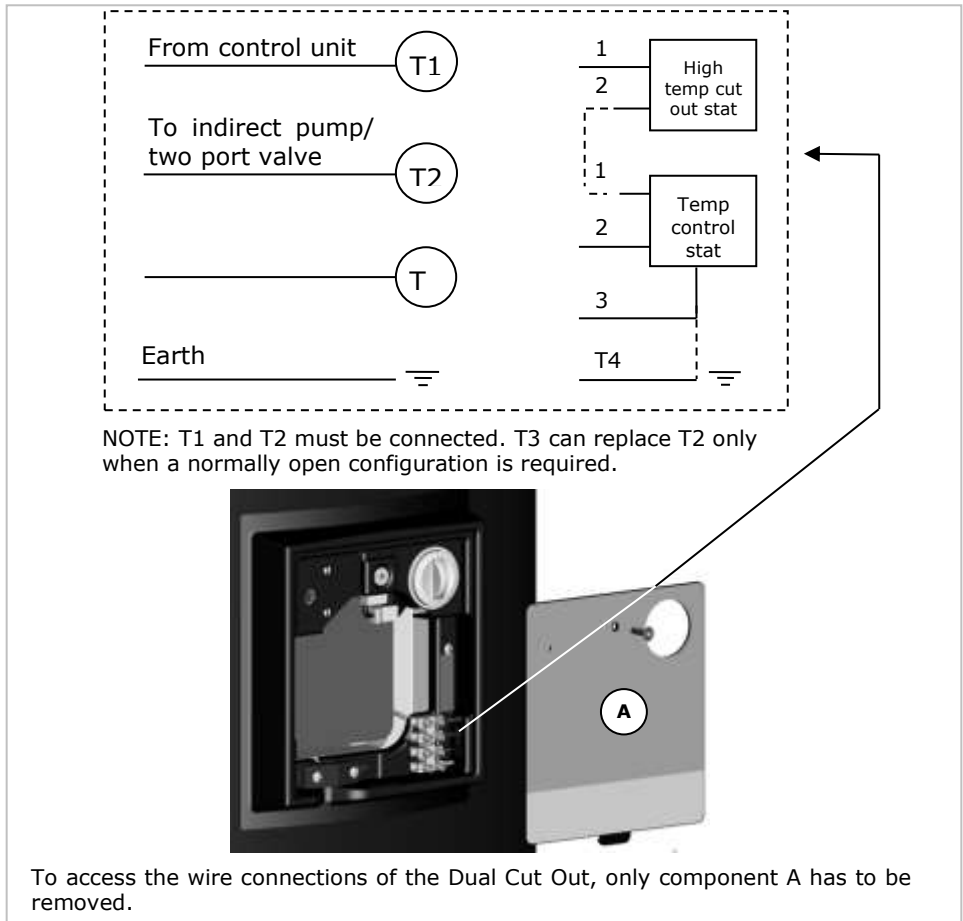

Figure 7: Thermostat Wiring Schematic

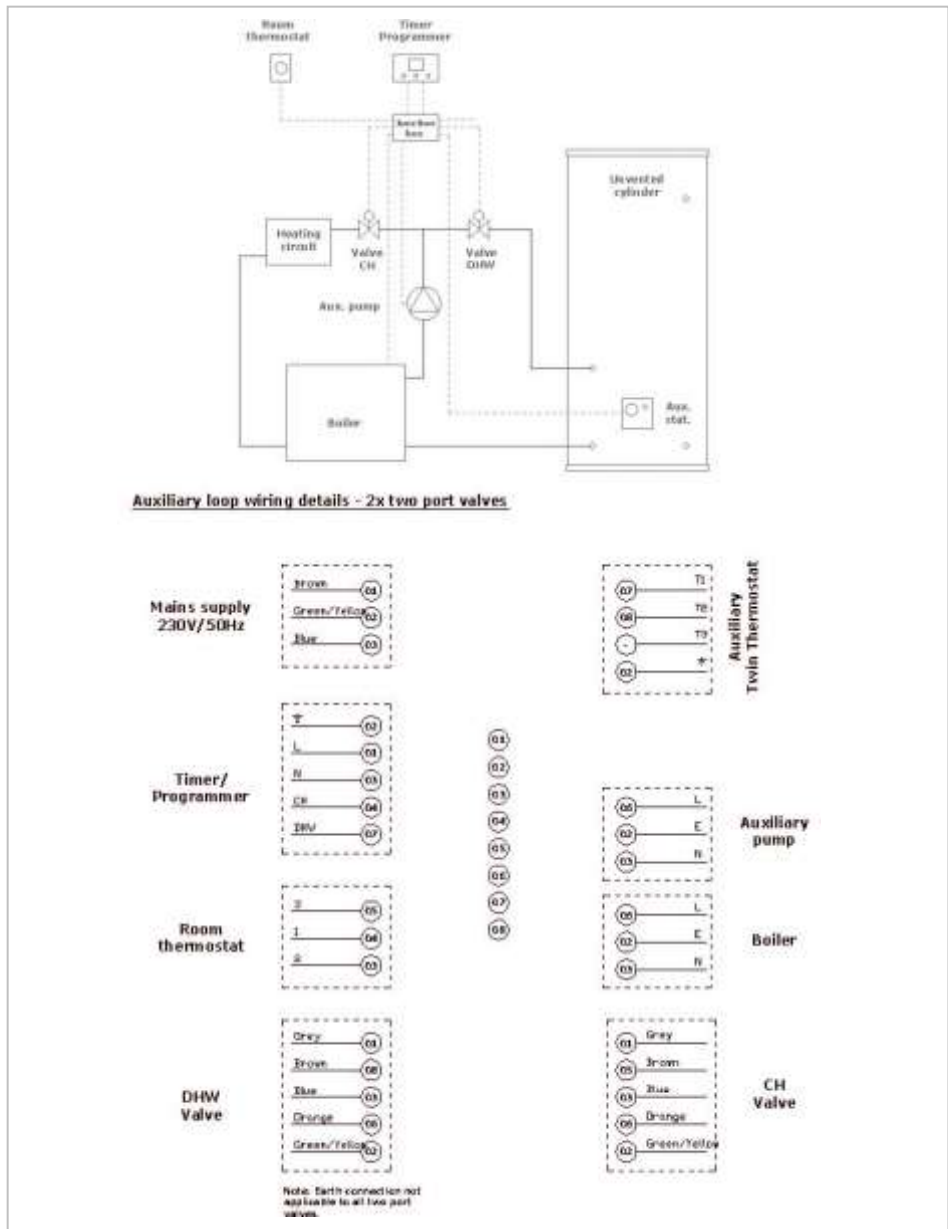

Figure 8: Auxiliary loop wiring details - 2 x two port valves

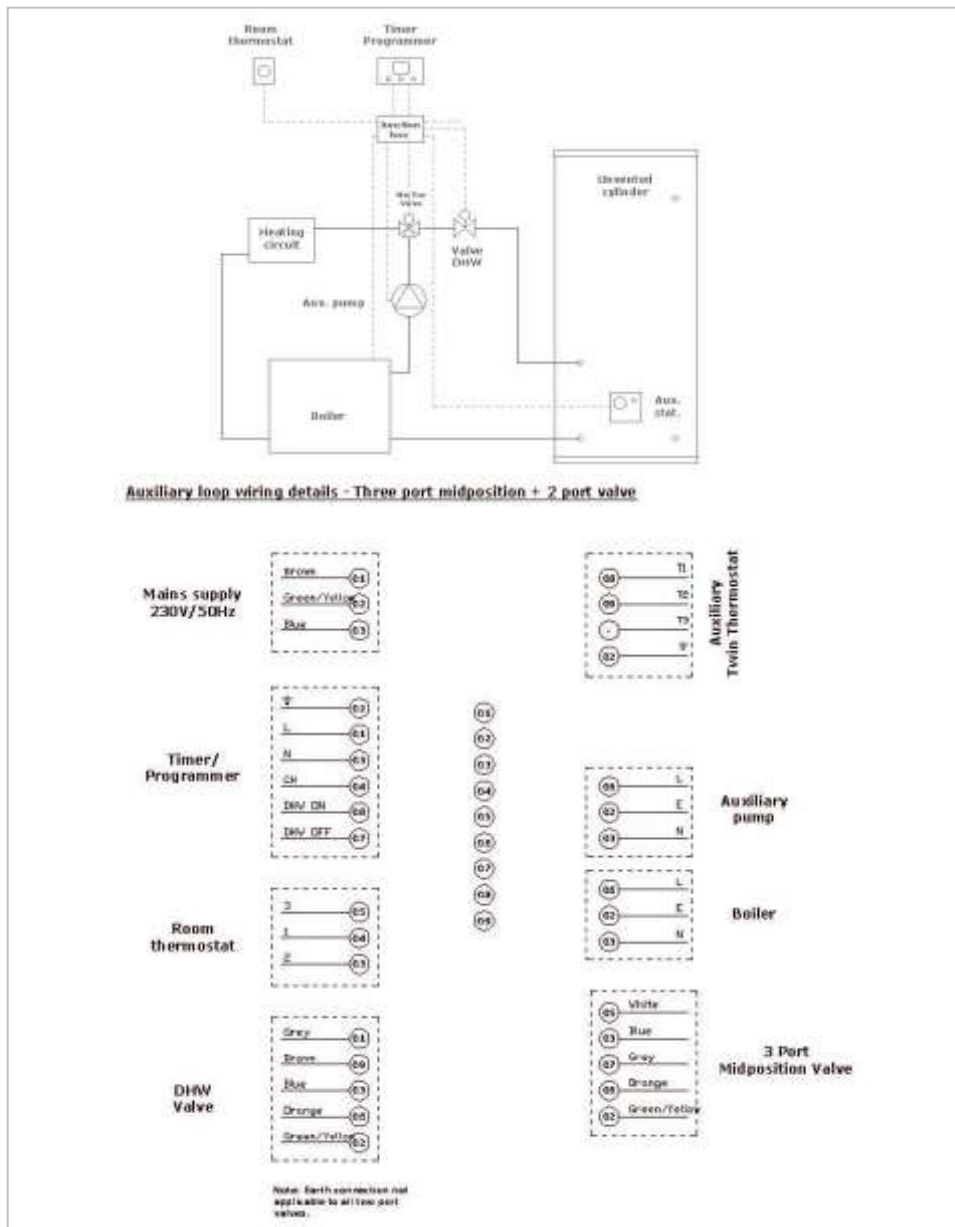

Figure 9: Auxiliary loop wiring details – Three port mid-position + 2 port valve

5.8 Connection of Secondary Return

For cylinders that do not have a dedicated secondary return connection, it is possible to install a secondary return by connecting a swept - T to the cold water inlet of the cylinder (see Figure 10).

The secondary return pipe should incorporate a check valve and a WRAS approved circulation pump; timer and thermostat to be provided separately. Where secondary return circuits are used, then an additional expansion vessel may be required.

The secondary return loop must avoid:

- stagnant water in long pipe runs
- long waiting times at draw off point for hot water
- undue water wastage

To minimise the energy consumption of the secondary return circuit and to ensure reliable operation it is important to consider:

- the control of the circulation pump to be time and temperature controlled
- the secondary return circuit pipe work to be insulated
- the secondary return pump to be of suitable material and specification

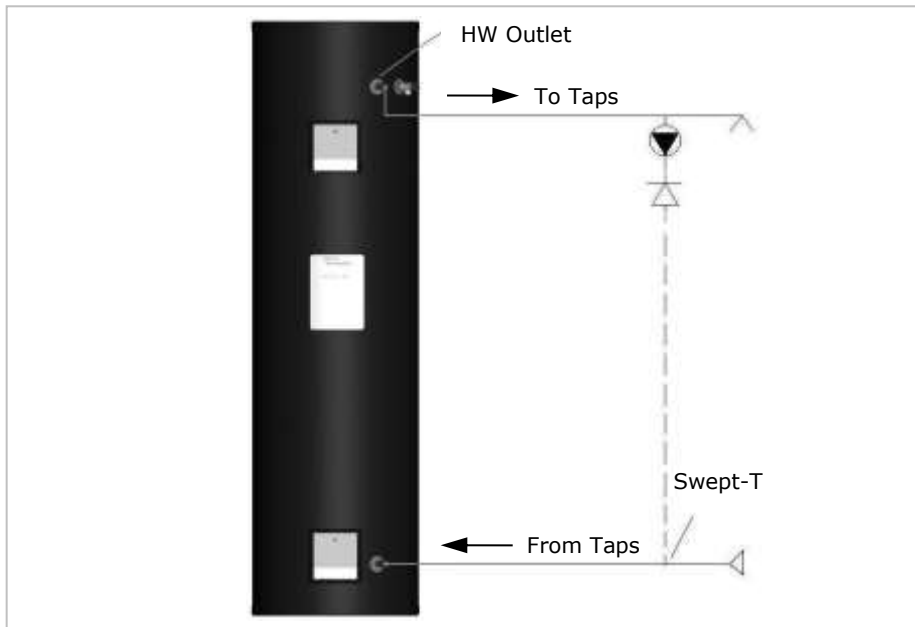

Figure 10: Secondary return loop

6 Commissioning

At the time of commissioning, complete all relevant sections of the Benchmark Checklist located on the inside back pages of this document.

The following commissioning procedures only detail the required steps to be taken for the potable water loop:

- 1) Before making any mains connections to the inlet control group, flush the mains pipework out to ensure all debris has been removed so as not to damage the strainer within the combination valve.
- 2) Make final mains connection on combination valve and check all connections and joints to ensure they have been tightened and secured correctly.
- 3) Before turning on the mains supply to the cylinder a hot water tap should be opened, preferably on the same floor or the floor below where the cylinder is located.
- 4) Check the pre-charge in the expansion vessel and ensure it is at least 3 bar. Note actual pressure on label on expansion vessel.
- 5) Turn on the supply to the cylinder and fill until water runs from the open hot water tap. Continue to flush the system until all debris has been removed.
- 6) Close the hot water tap.
- 7) Check all joints for leaks, even those not having been altered especially when replacing a vented cylinder.
- 8) Open temperature and pressure relief valve to ensure proper discharge and check after closing that valve is not dripping.
- 9) Open expansion relief valve to ensure proper discharge and check after closing that valve is not dripping.
- 10) Check all shower outlets, toilet cisterns and other draw off points for leaks or dripping (especially when replacing a vented unit). Open all water outlets to purge air from pipe work and ensure proper operation.
- 11) Adjust immersion heater thermostat in accordance with client requirements.
- 12) Instruct user in the operation of the unit and hand over this manual advising the owner of annual service requirements.
- 13) Complete the technical data label on the cylinder with legible and permanent writing.

7 Maintenance

After servicing, complete the relevant Service Record section of the Benchmark Checklist located on the inside back pages of this document. To meet with warranty requirements the cylinder must be serviced annually.



The maintenance of this appliance must be carried out by a suitably qualified person only. It is recommended to maintain the unit on an annual basis. Isolate all electrical supplies from the unit before commencing work. Danger of electrical shock!

- 1) Draw some water from cold water tap and retain in container.
- 2) Isolate cold water mains supply from cylinder.
- 3) Briefly open temperature and pressure relief valve, assure safe discharge and check that valve is not dripping when closed.
- 4) Briefly open expansion relief valve, assure safe discharge and check that valve is not dripping when closed. The expansion relief valve should be operated regularly to remove lime deposits and to verify that it is not blocked.
- 5) Open hot water tap and release remaining pressure from unit.
- 6) If the system is drained completely for an internal inspection, ensure the hot water tap remains open, connect a hose to the drain valve and ensure a safe discharge.
- 7) Note the set pressure of the pressure reducing valve. Remove cartridge and clean strainer in water provided in container. Re-assemble pressure reducing valve ensuring the correct pressure is set.
- 8) Periodically the immersion heaters should be removed cleaned and the unit flushed out. Check the O-ring seal for damage and replace if necessary.
- 9) Check electrical wiring connections and the condition of the cable of the immersion heater and the thermostat.
- 10) The immersion heater boss can also be used for access to view the internal components of the cylinder.
- 11) Re-commission unit (see chapter 6).

If the cylinder is not in use for excess of 1 month, it must be drained down by a competent person and recommissioned before use. Note: The immersion must be switched off at the mains before draining the cylinder.

If replacement parts are required, please see Figure 11 for part descriptions and part numbers.

CLEANING INSTRUCTIONS:



Clean outer cladding of cylinder with a soft cloth dampened with warm water only. Do not use abrasive or aggressive cleaning materials, such as alcohol or petroleum based solvents, as this may damage the surface of the product.



Waste electrical products should not be disposed of with household waste. Please recycle where facilities exist. Check with your Local Authority or retailer for recycling advice.

8 Spare Parts

Description		Part No	Direct	Indirect
22mm x 3bar Inlet control group		R00041-1	✓	✓
Inlet control group PRV cartridge		R00009-1	✓	✓
Inlet control group ERV		R01447-1	✓	✓
12 litre expansion vessel		R00044-2	✓	✓
18 litre expansion vessel		R00045-2	✓	✓
24 litre expansion vessel		R00046-2	✓	✓
Expansion vessel fixing kit		R00094-1	✓	✓
DN16 3/4" BSP x 1000 flex pipe		R00095-1	✓	✓
1/2" BSP TRP valve		R00020-1	✓	✓
15 x 22 straight PE tundish		R00047-1	✓	✓
1 3/4" N BSP 3kW Imm CW Stat		R03232-1	✓	✓
3/4" BSP 3kW x 14" Incoloy Immersion Heater		R01959-1	✓	✓
5npl Pole Rodstat CW Manual Reset		R01959-1	✓	✓
3kW Titanium Imm Htr CW rodstat		R01284-2	✓	✓
22mm/12l d/dST/HP CxL Safety Kit*		R00833-1	✓	✓
22mm/18l d/dST/HP CxL Safety Kit**		R00832-1	✓	✓
22mm/24l d/dST/HP CxL Safety Kit***		R00829-1	✓	✓
Standard Integrated Dual Cut Out enclosure		R01942-1	✗	✓
Standard Dual Cut Out Cover Plate Complete with Label		R01943-1	✗	✓
Standard Immersion enclosure		R01952-1	✓	✓
Standard Immersion Cover Plate Complete with Label		R01949-1	✓	✓
22mm motorised two port valve		R00048-1	✗	✓
Thread sealant		R00836-1	✓	✓
Direct Electric & Indirect Cylinders Installation & User Instructions manual		R01127-10	✓	✓
Terms and conditions		R01020-5	✓	✓

Figure 11: Replacement part numbers for Direct Electric and Indirect range of cylinders
 * ECSd125-580 & ECSd150-580 only, **ECSd210-580 only, ***ECSd250-580 & ECSd300-580 only

9 Technical Data and Product Fiche

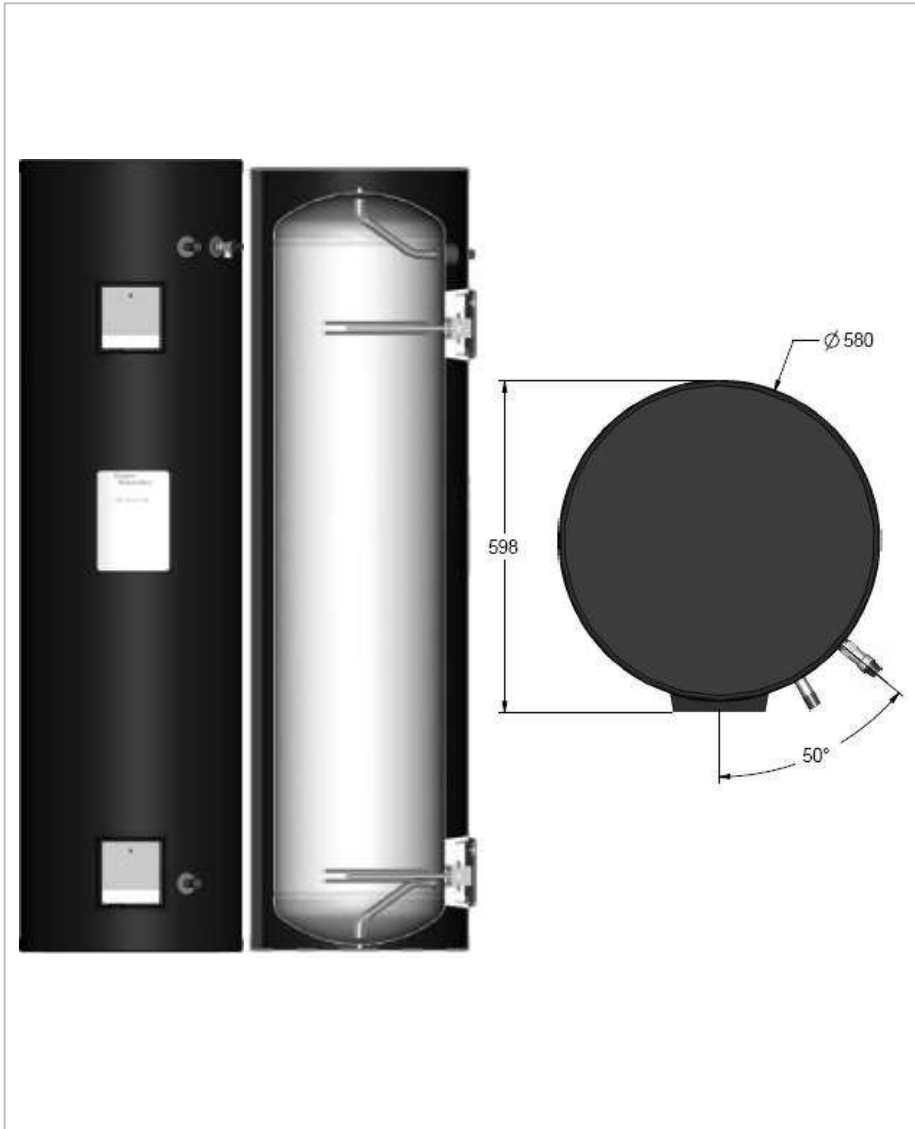

Figure 12: Direct Electric Cylinder and Cross-section (for reference only)

Direct Electric Cylinder Range - Dimensions					
Reference	125	150	210	250	300
Weight [kg]	23	26	33	39	46
Reheat time [mins]*	122	150	218	284	313
Heat Loss [kWh]	0.95	1.10	1.41	1.51	1.96
Height [mm]	945	1115	1490	1765	2065
Outer Diameter [mm]	580	580	580	580	580
HW Outlet [mm]	720	890	1265	1540	1840
T&P valve [mm]	720	890	1265	1540	1840
CW Inlet [mm]	180	180	180	180	180
Bottom Immersion [mm]	200	200	200	200	200
Top Immersion [mm]	560	695	1070	1345	1645

Table 5: Direct Electric Cylinder Product Dimensions

Note: All measurements are taken from the base of the cylinder to the mid-point on the item.

* Determined in accordance with EN160335-2-21.

GDC Group Ltd	Direct Electric Cylinder Range – Product Fiche				
Reference	ECSd125-580	ECSd150-580	ECSd210-580	ECSd250-580	ECSd300-580
Load Profile – Primary	M	M	M	L	L
Energy Rating	C	C	C	C	C
Energy Efficiency	36%	37%	36%	37%	37%
Annual Energy Consumption	1411	1389	1435	2739	2774
Load Profile – Secondary	-	-	-	M	M
Set Temperature	60°C	60°C	60°C	60°C	60°C
Sound Level [dB]	15dB	15dB	15dB	15dB	15dB
Operating Mode	Off Peak	Off Peak	Off Peak	Off Peak	Off Peak
V-40	204	242	355	415	490

Table 6: Direct Electric Cylinder Product Fiche

Direct Electric Cylinder Range – Product Features	
Materials - inner cylinder - outer cylinder - inlet/outlet - insulation	Duplex stainless steel LDX2101 HIPS Stainless steel 60mm PU foam (GWP=1, ODP=0)
Maximum operating conditions - potable water temperature - operating pressure	70°C 3 bar
Cold water supply - minimum dynamic pressure - maximum pressure - minimum flow rate	1.5 bar 12 bar 15 l/min
Connections - cold water inlet - hot water outlet	22mm stainless steel 22mm stainless steel
Immersion heater	1 ¾ F BSP 3kW
Thermostatic control - direct input	integral immersion heater thermostat and cut out
Safety components - pressure reducing valve and strainer - expansion relief valve - temp. and pressure relief valve - factory pressure test	3 bar 6 bar 7 bar/90°C 12 bar
Other features	Over 60% in volume from recycled materials# Surface mounted sensor devices for compatibility and ease of maintenance
Approvals	KIWA approval number:- 1112700
Guarantee - inner cylinder - immersion heaters - other components	25 yrs 2 yrs - excluding the effects of lime scale or other water borne contaminants 2 yrs - excluding expansion vessel membrane pressure

Table 7: Direct Electric Product features

Not including insulation

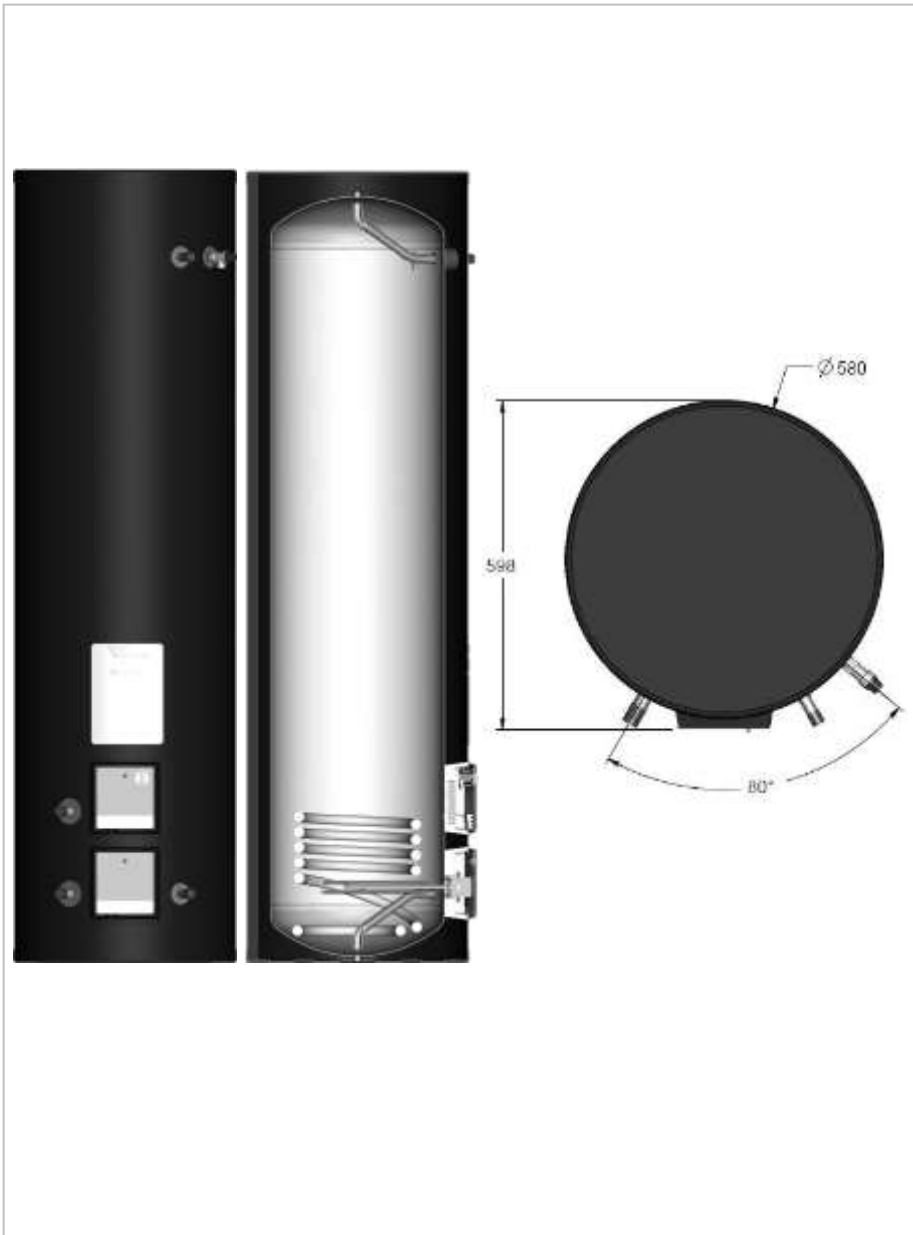

Figure 13: Indirect Cylinder and Cross-section (for reference only)

Indirect Cylinder Range – Product Dimensions					
Reference	125	150	210	250	300
Weight [kg]	25	29	36	42	47
Reheat time [mins]*	25	33	31	40	49
HX performance [kW]*	13	12	19	18	18
Heat Loss [kWh/24h]*	0.95	1.10	1.41	1.51	1.96
Height [mm]	945	1115	1490	1765	2065
Outer Diameter [mm]	580	580	580	580	580
HW Outlet [mm]	720	890	1265	1540	1840
T&P valve [mm]	720	890	1265	1540	1840
CW Inlet [mm]	180	180	180	180	180
Bottom Immersion [mm]	200	200	200	200	200
Indirect Return [mm]	180	180	180	180	180
Indirect Flow [mm]	315	315	395	395	395
Bottom Thermostat [mm]	420	420	420	420	420

Table 8: Indirect Cylinder Product Dimensions

Note: All measurements are taken from the base of the cylinder to the mid-point on the item.

* Determined in accordance with EN12897 at 80°C flow temperature and 0.25l/s flow rate.

GDC Group Ltd	Indirect Cylinder Range – Product Fiche				
Reference	ECSi125-580	ECSi150-580	ECSi210-580	ECSi250-580	ECSi300-580
Energy Rating	B	B	B	B	B
Standing Loss [W]	40	54	59	66	82
Storage Volume [L]	124	150	210	250	300

Table 9: Indirect Cylinder Product Fiche

Indirect Cylinder Range – Product Features						
Materials						
<ul style="list-style-type: none"> - inner cylinder - outer cylinder - inlet/outlet - coils - insulation 		Duplex stainless steel LDX2101 HIPS Stainless steel Stainless steel 60mm PU foam (GWP=1, ODP=0)				
Maximum operating conditions						
<ul style="list-style-type: none"> - potable water temperature - heating water temperature - operating pressure 		70°C 95°C 3 bar				
Cold water supply						
<ul style="list-style-type: none"> - minimum dynamic pressure - maximum pressure - minimum flow rate 		1.5 bar 12 bar 15 l/min				
Connections						
<ul style="list-style-type: none"> - cold water inlet - hot water outlet - coil flow and return 		22mm stainless steel 22mm stainless steel 22mm stainless steel				
Coil specification						
<ul style="list-style-type: none"> - surface area [m²] - rating [kW]* - max. working pres. Aux.[Bar] 		0.5		0.8		
		13	12	18	19	18
		3				
Immersion heater		1 ¾ F BSP 3kW				
Thermostatic control						
<ul style="list-style-type: none"> - direct input - indirect input 		integral immersion heater thermostat and cut out integral twin thermostat (10 to 70°C) and cut out (~85°C)				
Safety components						
<ul style="list-style-type: none"> - pressure reducing valve and strainer - expansion relief valve - temperature and pressure relief valve - factory pressure test 		3 bar 6 bar 7 bar/90°C 12 bar				
Other features		Over 60% in volume from recycled materials# Surface mounted sensor devices for compatibility and ease of maintenance				
Approvals		KIWA approval number:- 1112701				
Guarantee						
<ul style="list-style-type: none"> - inner cylinder - immersion heaters - Other components 		25 yrs 2 yrs - excluding the effects of lime scale or other water borne contaminants 2 yrs - excluding expansion vessel membrane pressure				

Table 10: Indirect Product Features

* Determined in accordance with EN12897 at 80°C flow temperature and 0.25l/s flow rate.

Not including insulation

9.1 Cylinder heat exchanger pressure drop

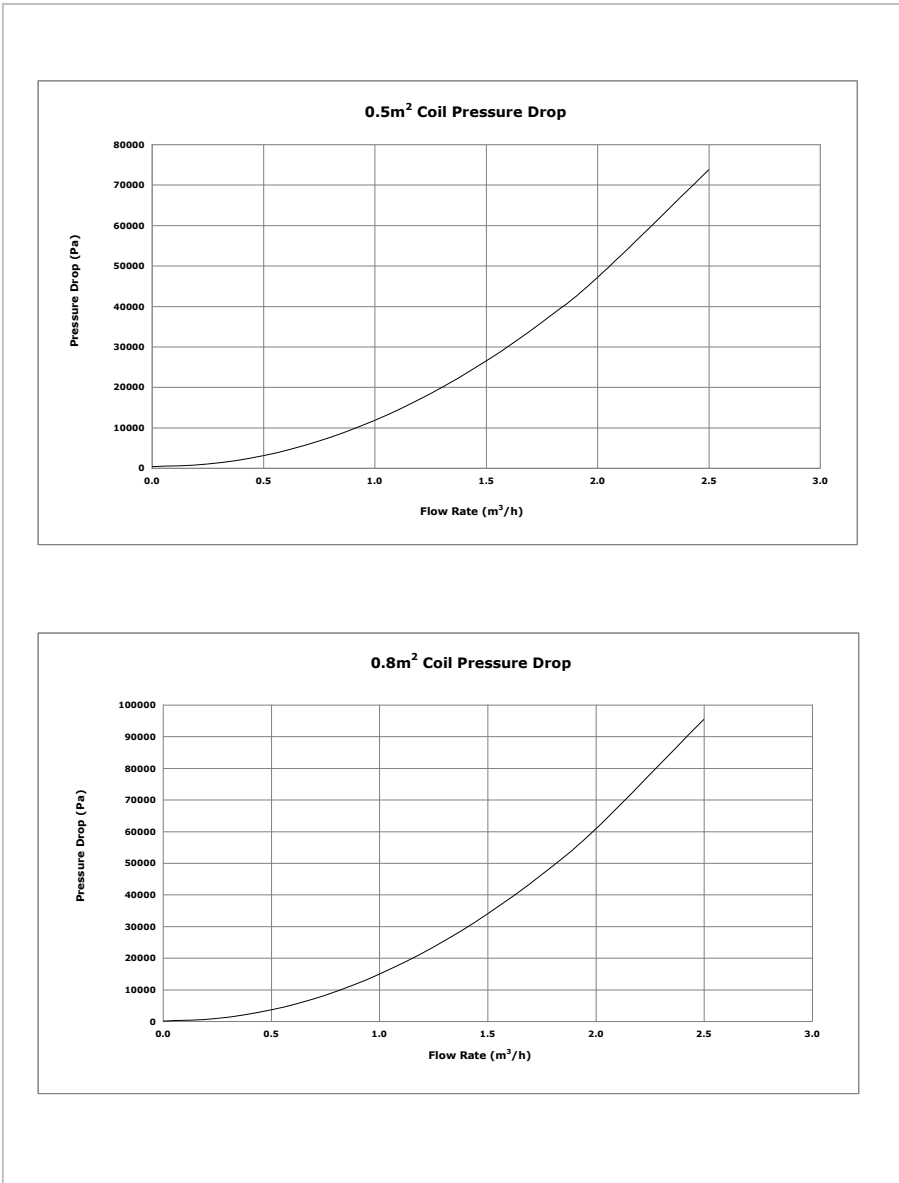

Figure 14: Heat exchanger pressure drops for 0.5m² and 0.8m² coils

10 User Instructions

10.1 General

"This appliance is not intended for use by persons (including children) with reduced physical, sensory or mental capabilities, or lack of experience and knowledge, unless they have been given supervision or instruction concerning the use of the appliance by person responsible for their safety."

"Children should be supervised to ensure they do not play with this appliance."

Please read the following statements carefully as it affects your warranty:

Please ensure that the installer has fully completed the Benchmark Checklist on the inside back pages of this document and that you have signed it to say that you have received a full and clear explanation of its operation. The installer is legally required to complete a commissioning checklist as a means of complying with the appropriate Building Regulations Part G3 (England and Wales), Part P of Northern Ireland and Section 6 of Scotland.

All installations must be notified to Local Area Building Control either directly or through a Competent Persons Scheme. A Building Regulations Compliance Certificate will then be issued to the customer who should, on receipt, write the Notification Number on the Benchmark Checklist.

This product should be serviced annually to optimise its safety, efficiency and performance. The service engineer should complete the relevant Service Record on the Benchmark Checklist after each service.

The Benchmark Checklist will be required in the event of any warranty work.

10.2 Operation

Once the system has been fully commissioned, no user intervention should be required to fully enjoy the comfort and benefits of the unvented hot water cylinder.

The hot water temperature can be set to various requirements. It is recommended to set the indirect hot water temperature to between 45°C and 60°C (please refer to Figure 16 for approximate settings). Higher temperatures can cause tripping of the high limit thermostat, introduce more heat loss from the unit and increase the risk of scalding significantly.

When turning on a hot tap for the first time after a heat up period there might be a short surge of water. This is normal in unvented systems and does not constitute a fault. Sometimes the water may appear milky – this is due to very fine air bubbles in the water which will clear quickly.

10.2.1 Water temperature direct electric heating



Before removing the cover from the immersion heater isolate appliance using isolating switch! Danger of electrical shock! Only use suitable electrically insulated equipment when working inside immersion housing.

The hot water temperature achieved by the direct electric heating element can be adjusted by removing the cover from the immersion heater and adjusting the dial up or down as indicated in Figure 15. As a default the maximum position is selected, which is equivalent to 60°C.

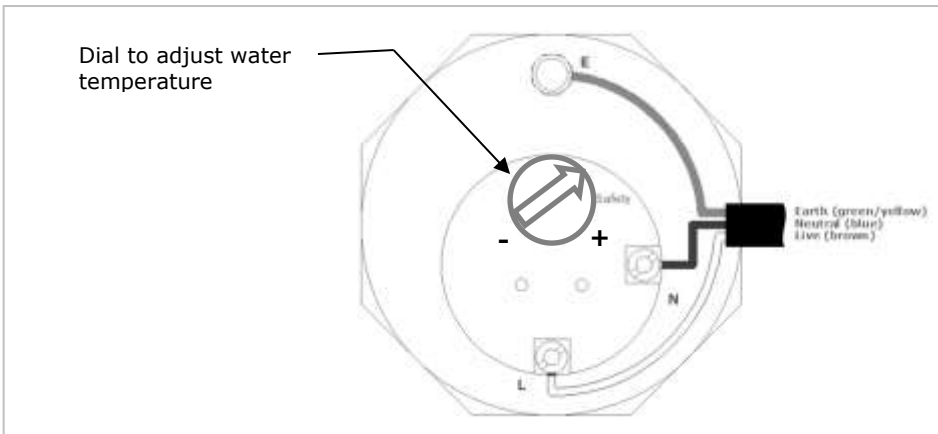

Figure 15: Adjustment water temperature direct electric heating element

10.2.2 Water temperature auxiliary heating

The water temperature achieved by the auxiliary heating system depends on the setting of the thermostat on:

- the cylinder AND
- the auxiliary / solar heating source

The adjustment at the cylinder is carried out on the twin thermostat fitted to the cylinder as shown in Figure 16. In the event that the high temperature cut-out engages, it will be necessary to manually reset the thermostat. Use a suitable electrically insulated tool to push the manual reset button and inform the installer.

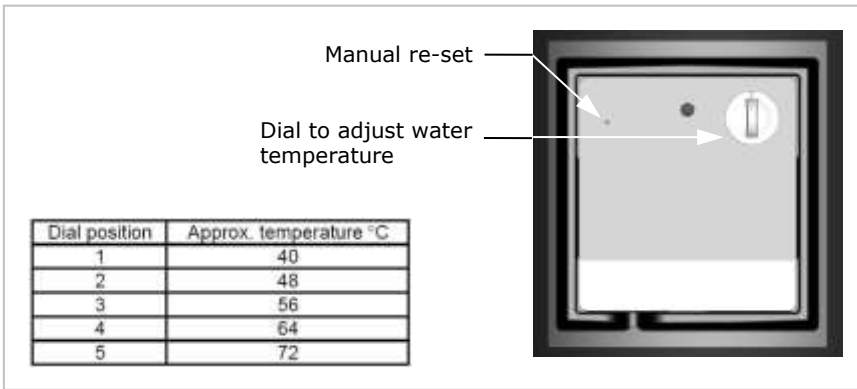

Figure 16: Adjustment water temperature auxiliary source

10.3 Maintenance



The maintenance of this appliance must be carried out by a suitably qualified person only. It is recommended to maintain the unit on an annual basis. Isolate all electrical supplies from the unit before commencing work. Danger of electrical shock! See section 7.

10.4 Troubleshooting

Fault	Cause	Solution
A No water from hot water taps	A.1 Stop valve closed A.2 Strainer blocked A.3 Pressure reducing valve fitted against flow	A.1 Open stop valve A.2 Turn water supply off, clean strainer and re-commission A.3 Re-fit with arrow showing in direction of flow
B No hot water	B.1 Timer/Programmer not set correctly B.2 Indirect heating malfunction B.3 Direct heating malfunction B.4 Indirect/direct heating high limit thermostat has tripped	B.1 Set timer/programmer correctly B.2 Consult indirect heating system instructions B.3 Call for qualified person to check immersion heater B.4 Reset limit thermostat(s) and inform installer
C Intermittent water discharge through tundish on warm-up	C.1 Expansion vessel lost charge	C.1 Check expansion vessel (see commissioning/maintenance), top up or replace
D Continuous discharge	D.1 Pressure reducing valve not working D.2 Pressure relief or T&P valve not seating correctly D.3 Malfunction of high limit thermostat or appliance	D.1 Check pressure after valve and replace if faulty D.2 Manually lift valve once or twice to clear debris, otherwise replace D.3 Check function of thermostats and appliances
E Leakage from casing	E.1 Compression/threaded joints not formed correctly	E.1 Re-seal joints with care
F Hot water from cold tap	F.1 Hot pipe work being routed adjacent to cold pipe work F.2 Leaking seal in mixer tap	F.1 Insulate hot pipe work or re-route F.2 Replace seals in mixer tap
G Metallic noise from system	G.1 Pipe work not sufficiently supported	G.1 Add extra pipe work fixings
H Humming noise from system during re-heat	H.1 Air in system H.2 Flow rate well in excess of specification	H.1 Bleed system thoroughly and re-pressurize H.2 Reduce pump speed

Notes

Notes

MAINS PRESSURE HOT WATER STORAGE SYSTEM COMMISSIONING CHECKLIST

This Commissioning Checklist is to be completed in full by the competent person who commissioned the storage system as a means of demonstrating compliance with the appropriate Building Regulations and then handed to the customer to keep for future reference.

Failure to install and commission this equipment to the manufacturer's instructions may invalidate the warranty but does not affect statutory rights.

Customer Name _____ Telephone Number _____
 Address _____
 Cylinder Make and Model _____
 Cylinder Serial Number _____
 Commissioned by (*print name*) _____ Registered Operative ID Number _____
 Company Name _____ Telephone Number _____
 Company Address _____
 _____ Commissioning Date _____

To be completed by the customer on receipt of a Building Regulations Compliance Certificate*:
 Building Regulations Notification Number (*if applicable*) _____

ALL SYSTEMS PRIMARY SETTINGS (indirect heating only)

Is the primary circuit a sealed or open vented system? Sealed Open
 What is the maximum primary flow temperature? _____ °C

ALL SYSTEMS

What is the incoming static cold water pressure at the inlet to the system? _____ bar
 Has a strainer been cleaned of installation debris (if fitted)? Yes No
 Is the installation in a hard water area (above 200ppm)? Yes No
 If yes, has a water scale reducer been fitted? Yes No
 What type of scale reducer has been fitted? _____
 What is the hot water thermostat set temperature? _____ °C
 What is the maximum hot water flow rate at set thermostat temperature (measured at high flow outlet)? _____ l/min
 Time and temperature controls have been fitted in compliance with Part L of the Building Regulations? Yes
 Type of control system (if applicable) Y Plan S Plan Other
 Is the cylinder solar (or other renewable) compatible? Yes No
 What is the hot water temperature at the nearest outlet? _____ °C
 All appropriate pipes have been insulated up to 1 metre or the point where they become concealed Yes

UNVENTED SYSTEMS ONLY

Where is the pressure reducing valve situated (if fitted)? _____ bar

What is the pressure reducing valve setting? _____ Yes No

Has a combined temperature and pressure relief valve and expansion valve been fitted and discharge tested? _____ Yes No

The tundish and discharge pipework have been connected and terminated to Part G of the Building Regulations _____ Yes No

Are all energy sources fitted with a cut out device? _____ Yes No

Has the expansion vessel or internal air space been checked? _____ Yes No

THERMAL STORES ONLY

What store temperature is achievable? _____ °C

What is the maximum hot water temperature? _____ °C

ALL INSTALLATIONS

The hot water system complies with the appropriate Building Regulations _____ Yes

The system has been installed and commissioned in accordance with the manufacturer's instructions _____ Yes

The system controls have been demonstrated to and understood by the customer _____ Yes

The manufacturer's literature, including Benchmark Checklist and Service Record, has been explained and left with the customer _____ Yes

Commissioning Engineer's Signature _____

Customer's Signature _____

(To confirm satisfactory demonstration and receipt of manufacturer's literature)

*All installations in England and Wales must be notified to Local Authority Building Control (LABC) either directly or through a Competent Persons Scheme. A Building Regulations Compliance Certificate will then be issued to the customer.



SERVICE RECORD

It is recommended that your hot water system is serviced regularly and that the appropriate Service Record is completed.

Service Provider

Before completing the appropriate Service Record below, please ensure you have carried out the service as described in the manufacturer's instructions.

SERVICE 1 Date

 Engineer Name

 Company Name

 Telephone Number

 Comments

 Signature

SERVICE 2 Date

 Engineer Name

 Company Name

 Telephone Number

 Comments

 Signature

SERVICE 3 Date

 Engineer Name

 Company Name

 Telephone Number

 Comments

 Signature

SERVICE 4 Date

 Engineer Name

 Company Name

 Telephone Number

 Comments

 Signature

Dimplex a division of GDC Group Ltd
Millbrook House Grange Drive, Hedge End, Southampton SO30 2DF
Tel.: 0845 600 5111
e-mail: aftersales@dimplex.co.uk
www.dimplex.co.uk